

ERNST[®]
— MANUFACTURING INC. —

THE LEADER
— IN —
TOOL
ORGANIZATION



MADE IN THE USA

LIFETIME GUARANTEE

TOOL ORGANIZERS | SHOP SOLUTIONS 2024



MADE IN THE USA
LIFETIME GUARANTEE

As any tool user knows, keeping your tools and your workspace organized is vital to working at your best. However, staying organized is also one of a tool user's biggest challenges!

Ernst is devoted to helping you manage your tool storage and organization. We know that options are a must as every set of tools is as unique as the individual who owns them. In this catalog you will find the widest variety of tool organizers on the market in one place. Our products are always great items to keep on hand in any garage. Get prepared and work smart with these convenient time-saving products.

All Ernst products are proudly made in the USA and are backed by a lifetime guarantee. That's a promise direct from the manufacturer!

REV IT UP!



Thank you from the team at
Ernst Manufacturing, Inc.



CONTENTS

	2-4	Featured Products	
SOCKETS	5-7	Socket Boss®	
	7	Socket Boss Combo Pack	
	8	Boss Series Custom Organization	
	9	Twist Lock Socket Organizers	
	9	Dura-Pro HD Socket Organizers	
	10	Magnetic Twist Lock Socket Organizers	
	11	Ratchet and Extension Holders	
	11	Socket Clip Packs	
BITS	11	Ratchet and Extension Tray NEW	
	12	Bit Boss®	
	12	Bit Bar	
	12	Bit Buddy	
	WRENCHES	13-14	Gripper Wrench Organizers
		15	Wrench Tool Towers
15		Wrench Organizer Trays	
16		No-Slip Low Profile Wrench Rails	
16		Wrench Rail Organizers	
17		Wrench Pro NEW	
18		Plier Pro®	
SCREWDRIVERS	19	No-Slip Low Profile Screwdriver Rails	
	19	Screwdriver Rail Organizers	
	19	V-Slot™ Screwdriver Organizer	
	20	Screwdriver Grippers	
	20	Screwdriver Organizer Trays	
	21	Tool Organizer Pro Pack	
COMBOS	21	Gripper Wrench Organizer Pack	
	21	Wrench Organizer Tray Packs	
SHOP SOLUTIONS	22	Tray Organizers	
	23	Shop Chocks	
	23	Greg's Oil Filter Funnel	
	24	Jack Stand Covers	
	24	Ultra-Flex Wheel Protector	
	25	Featured Products	
	26	Getting Social	

All products come with a Lifetime Guarantee.

Applicable patents US 6,637,605, US 8,770,418, US 6,039,178, US D415,913, US 6,250,466, US 6,871,921, US D392,489, US 5,638,964, US D697,539, US 8,578,975, US 8,833,336, US 6,457,780, US 10,449,665

NEW PRODUCT

WRENCH PRO

MODULAR WRENCH ORGANIZER

PAGE 17



A VERSATILE WRENCH ORGANIZER DESIGNED TO SAVE VALUABLE SPACE IN THE TOOLBOX BY STORING WRENCHES UPRIGHT, FITTING MORE TOOLS IN A COMPACT SPACE.

FITS A WIDE RANGE OF WRENCH TYPES AND SIZES. CLEATS SINK INTO DRAWER LINER, PREVENTING MOVEMENT WHEN DRAWERS ARE OPENED AND CLOSED.



Maximum toolbox versatility

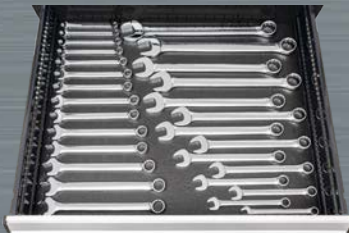

Before



After



ID Labels Included

Modular Design

SNAPS TOGETHER FOR CUSTOM CONFIGURATIONS

Magnetic option

STRONG MAGNETS FOR STABILITY



BIT BAR & BIT BUDDY

WITH MAGNETIC MOUNT

PAGE 12

INTRODUCING NEW COMPACT & CONVENIENT BIT STORAGE - IN 18", 13" AND 8" OPTIONS!

LONG BITS? SHORT BITS? WITH A WIDE ARRAY OF CONFIGURATION OPTIONS AND COLORS, WE HAVE YOU COVERED. GREAT FOR IN THE BOX, MOUNTED ON THE SIDE OR ON THE GO.

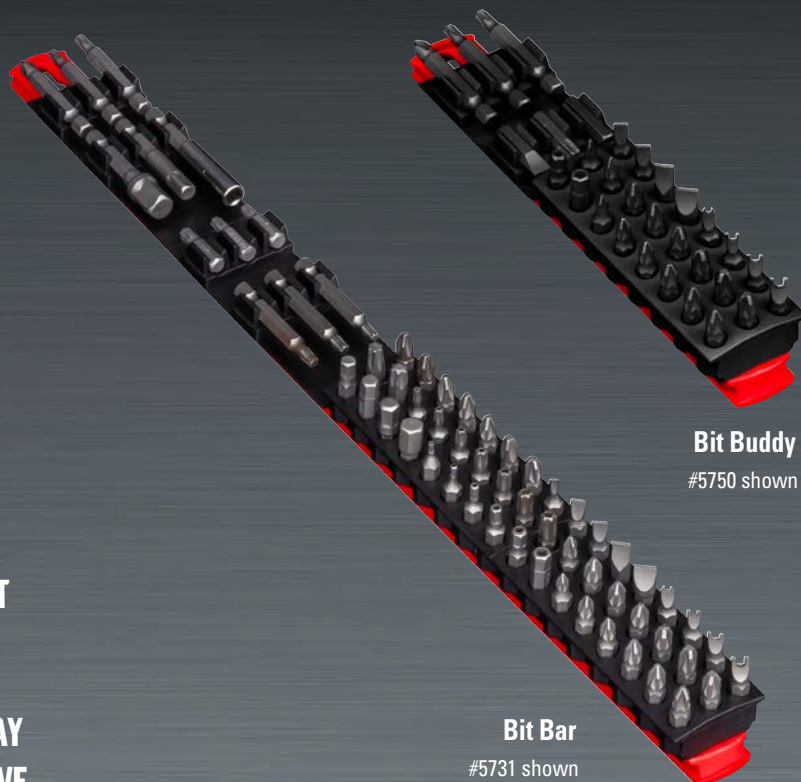

Bit Buddy
#5750 shown

Bit Bar
#5731 shown



Secure Taper Lock
HOLDS FIRM AND RELEASES EASILY

Magnetic
STRONG MAGNETS MOUNT VERTICALLY

Versatile
HOLDS 3/8" DRIVE CHUCKS

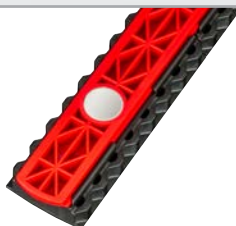
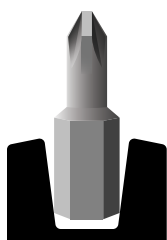

TWIST LOCK SOCKET CLIPS

Our Twist Lock socket organizers provide all the versatility you have come to expect from Ernst, with added "stay put" security

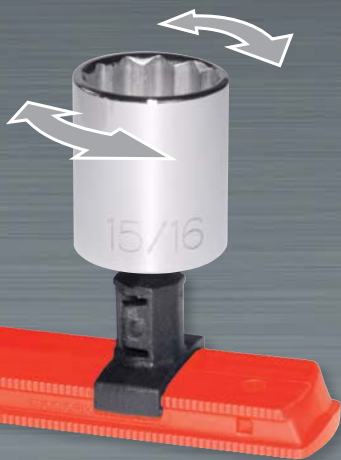

With a simple twist your sockets are firmly secured in a locked position.

Twist in the reverse direction and your sockets are free to remove. The tension is a perfect medium so you do not have to fight with your sockets to lock them into place and you don't have to worry about them being too loose. Just a simple 1/8" turn and your tools are secured. That's great news for those of you who need to transport sockets around the shop – wait, isn't that all of us?

Tools not included

Place



Twist



Locked



AVAILABLE IN 4 DRIVE SIZES
PATENT US 8,770,418

CHECK OUT OUR LINE OF PRODUCTS WITH
TWIST LOCK CLIPS ON PAGES 5-11



®
SOCKET BOSS

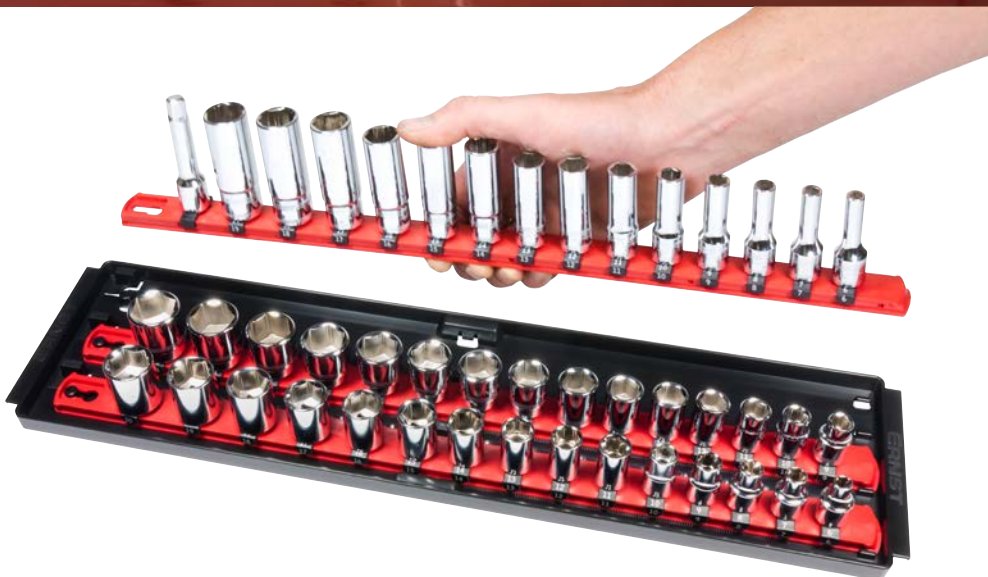

WITH OUR SOCKET BOSS LINE, you can transport sockets, securely store expensive sets, organize socket drawers, and save space! Extra socket clips and ratchet and extension holders are easy to add on for custom configurations. Universal socket rails can interchange between socket trays. ID stickers included for socket identification. Available in multiple configurations and colors. *Patents US 6,637,605, US 8,770,418, US 9,364,949, D725,993S*

SEE PAGES 6-8



Tools not included



<https://youtu.be/MvZTwrh2ZGI>

Versatile

Transportable

Secure



Socket Boss® with 18" Rails



Pre-configured tray sets are ready for your sockets! ID stickers included.

Dimensions: 3 Rail - 19.60"x 5.30"x 1.40" 2 Rail w/ 1/4" clips - 19.60"x 3.60"x 1.00" 2 Rail w/ 3/8" clips - 19.60"x 3.60"x 1.20" 2 Rail w/ 1/2" clips - 19.60"x 3.60"x 1.40"

- #8450 3 Rail Twist Lock Socket Boss 18" - Red
- #8451 3 Rail Twist Lock Socket Boss 18" - Blue
- #8481 3 Rail Twist Lock Socket Boss 18" - Green
- #8482 3 Rail Twist Lock Socket Boss 18" - Orange
- #8460HV 3 Rail Twist Lock Socket Boss 18" - HI-VIZ
Includes 57 socket clips – 22 of 1/4", 18 of 3/8" and 17 of 1/2" drives
- #8452 2 Rail Twist Lock Socket Boss 18" - Red 1/4"
- #8455 2 Rail Twist Lock Socket Boss 18" - Blue 1/4"
- #8483 2 Rail Twist Lock Socket Boss 18" - Green 1/4"
- #8484 2 Rail Twist Lock Socket Boss 18" - Orange 1/4"
- #8461HV 2 Rail Twist Lock Socket Boss 18" - HI-VIZ 1/4"
Includes 44 socket clips each
- #8453 2 Rail Twist Lock Socket Boss 18" - Red 3/8"
- #8456 2 Rail Twist Lock Socket Boss 18" - Blue 3/8"
- #8485 2 Rail Twist Lock Socket Boss 18" - Green 3/8"
- #8486 2 Rail Twist Lock Socket Boss 18" - Orange 3/8"
- #8462HV 2 Rail Twist Lock Socket Boss 18" - HI-VIZ 3/8"
Includes 36 socket clips each
- #8454 2 Rail Twist Lock Socket Boss 18" - Red 1/2"
- #8457 2 Rail Twist Lock Socket Boss 18" - Blue 1/2"
- #8487 2 Rail Twist Lock Socket Boss 18" - Green 1/2"
- #8488 2 Rail Twist Lock Socket Boss 18" - Orange 1/2"
- #8463HV 2 Rail Twist Lock Socket Boss 18" - HI-VIZ 1/2"
Includes 34 socket clips each
- #8458 2 Rail Twist Lock Socket Boss 18" - Red 3/4"
- #8459 2 Rail Twist Lock Socket Boss 18" - Blue 3/4"
Includes 14 socket clips each



3 Rail Socket Boss 18"

#8450 shown



2 Rail Socket Boss 18" – 1/4"

#8452 shown



2 Rail Socket Boss 18" – 3/8"

#8453 shown



2 Rail Socket Boss 18" – 1/2"

#8454 shown



2 Rail Socket Boss 18" – 3/4"

#8458 shown

Socket Boss® with 13" Rails ■ ■ ■

Pre-configured tray sets are ready for your sockets! ID stickers included.

Dimensions: 3 Rail - 14.90"x 5.30"x 1.40" 2 Rail w/ 1/4" clips - 14.90"x 3.60"x 1.00"
2 Rail w/ 3/8" clips - 14.90"x 3.60"x 1.20" 2 Rail w/ 1/2" clips - 14.90"x 3.60"x 1.40"

- #8490 3 Rail Twist Lock Socket Boss 13" - Red
- #8491 3 Rail Twist Lock Socket Boss 13" - Blue
- #8498HV 3 Rail Twist Lock Socket Boss 13" - HI-VIZ
Includes 40 socket clips – 15 of 1/4", 14 of 3/8", 11 of 1/2" drive
- #8492 2 Rail Twist Lock Socket Boss 13" - Red 1/4"
- #8495 2 Rail Twist Lock Socket Boss 13" - Blue 1/4"
- #8467HV 2 Rail Twist Lock Socket Boss 13" - HI-VIZ 1/4"
Includes 30 socket clips each
- #8493 2 Rail Twist Lock Socket Boss 13" - Red 3/8"
- #8496 2 Rail Twist Lock Socket Boss 13" - Blue 3/8"
- #8468HV 2 Rail Twist Lock Socket Boss 13" - HI-VIZ 3/8"
Includes 28 socket clips each
- #8494 2 Rail Twist Lock Socket Boss 13" - Red 1/2"
- #8497 2 Rail Twist Lock Socket Boss 13" - Blue 1/2"
- #8469HV 2 Rail Twist Lock Socket Boss 13" - HI-VIZ 1/2"
Includes 22 socket clips each



3 Rail Socket Boss 13"

#8490 shown



2 Rail Socket Boss 13" – 1/4"

#8492 shown



2 Rail Socket Boss 13" – 3/8"

#8493 shown



2 Rail Socket Boss 13" – 1/2"

#8494 shown

Socket Boss Combo Packs ■ ■ ■

Includes a 2 rail Socket Boss and a ratchet and extension of each drive size: 1/4", 3/8", and 1/2". Holds a total of 114 sockets (44 of 1/4", 36 of 3/8", and 34 of 1/2"). ID stickers included.

- #8510 Socket Boss Combo Pack 18" - Red
- #8511 Socket Boss Combo Pack 18" - Blue
- #8512 Socket Boss Combo Pack 18" - HI-VIZ

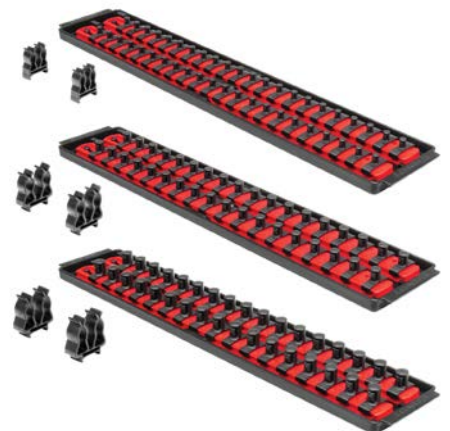

#8510 shown

BOSS SERIES CUSTOMIZED



We know every tool owner has unique needs and we provide the options for custom organization. Mix and match to your heart's content. Add any combination of rails, clips, and accessories to our Boss Series trays to create your own setup. Look for the sign - Find Boss Series compatible products on pages 9, 10, 11 and 12.



Tools not included

STEP ONE

Boss Series Trays

Dimensions: 3 Rail 18" Tray - 19.60"x 5.30"x .60" 2 Rail 18" Tray - 19.60"x 3.60"x .60"
3 Rail 13" Tray - 14.90"x 5.30"x .60" 2 Rail 13" Tray - 14.90"x 3.60"x .60"

- #8430 3 Rail Boss Series Tray 18" - Black *tray only*
- #8431 2 Rail Boss Series Tray 18" - Black *tray only*
- #8432 3 Rail Boss Series Tray 13" - Black *tray only*
- #8433 2 Rail Boss Series Tray 13" - Black *tray only*



#8430 shown



#8432 shown

STEP TWO

Boss Series Rails

PRE-BUILT SOCKET RAILS See Page 9 and 10.

PRE-BUILT BIT BAR RAILS See Page 12.

UNIVERSAL SOCKET RAILS

Dimensions: 18" Rail - 18.00"x 1.00"x .40" 13" Rail - 13.00"x 1.00"x .40"

- #8384B 18" Universal Socket Rail - Red
- #8385B 18" Universal Socket Rail - Blue
- #8386B 18" Universal Socket Rail - Black
- #8387B 18" Universal Socket Rail - HI-VIZ
- #8388B 18" Universal Socket Rail - Green
- #8389B 18" Universal Socket Rail - Orange
- #8390B 13" Universal Socket Rail - Red
- #8391B 13" Universal Socket Rail - Blue
- #8392B 13" Universal Socket Rail - Black
- #8393B 13" Universal Socket Rail - HI-VIZ



#8402 shown



#5731 shown



#8384B shown



#8390B shown

STEP THREE

Boss Series Accessories

SOCKET ACCESSORIES For a full list of compatible Boss Series accessories see Page 11.

SOCKET BOSS ACCESSORY PACK Includes 1/4", 3/8" and 1/2" Face Mount Ratchet & Extension Holders and 22 of 1/4", 18 of 3/8" and 17 of 1/2" Twist Lock Socket Clips. Patents US 6,250,466 US 8,770,418

- #8445 Socket Boss Accessory Pack



Twist Lock Socket Organizers ■ ■ ■ ■

Add, remove, and insert clips on any portion of the socket rail to fit your custom set of tools. Integrate with a wide array of accessories (page 11). ID stickers included. *Patents US 6,637,605, US 8,770,418*



18" Socket Organizer w/ (22) 1/4" Drive Twist Lock Socket Clips
#8434HV HI-VIZ-1/4" **#8400** Red-1/4" **#8403** Blue-1/4" **#8420** Black-1/4"

18" Socket Organizer w/ (18) 3/8" Drive Twist Lock Socket Clips
#8435HV HI-VIZ-3/8" **#8401** Red-3/8" **#8404** Blue-3/8" **#8421** Black-3/8"

18" Socket Organizer w/ (17) 1/2" Drive Twist Lock Socket Clips
#8436HV HI-VIZ-1/2" **#8402** Red-1/2" **#8405** Blue-1/2" **#8422** Black-1/2"

Dimensions: 18" Rail w/ 1/4" clips - 18.00"x 1.10"x .90"
 w/ 3/8" clips - 18.00"x 1.10"x .90" w/ 1/2" clips - 18.00"x 1.10"x 1.20"



13" Socket Organizer w/ (15) 1/4" Drive Twist Lock Socket Clips
#8437HV HI-VIZ-1/4" **#8414** Red-1/4" **#8417** Blue-1/4" **#8423** Black-1/4"

13" Socket Organizer w/ (14) 3/8" Drive Twist Lock Socket Clips
#8438HV HI-VIZ-3/8" **#8415** Red-3/8" **#8418** Blue-3/8" **#8424** Black-3/8"

13" Socket Organizer w/ (11) 1/2" Drive Twist Lock Socket Clips
#8439HV HI-VIZ-1/2" **#8416** Red-1/2" **#8419** Blue-1/2" **#8425** Black-1/2"

Dimensions: 13" Rail w/ 1/4" clips - 13.00"x 1.10"x .90"
 w/ 3/8" clips - 13.00"x 1.10"x .90" w/ 1/2" clips - 13.00"x 1.10"x 1.20"

8" Socket Organizer w/ (9) 1/4" Drive Twist Lock Socket Clips
#8410 Red-1/4" **#8407** Blue-1/4" **#8426** Black-1/4"

8" Socket Organizer w/ (9) 3/8" Drive Twist Lock Socket Clips
#8411 Red-3/8" **#8408** Blue-3/8" **#8427** Black-3/8"

8" Socket Organizer w/ (7) 1/2" Drive Twist Lock Socket Clips
#8412 Red-1/2" **#8409** Blue-1/2" **#8428** Black-1/2"

Dimensions: 8" Rail w/ 1/4" clips - 8.00"x 1.10"x .90"
 w/ 3/8" clips - 8.00"x 1.10"x .90" w/ 1/2" clips - 8.00"x 1.10"x 1.20"



Tools not included



18" Socket Organizer with 1/2" Drive Socket Clips
 #8402 shown



13" Socket Organizer with 3/8" Drive Socket Clips
 #8415 shown



8" Socket Organizer with 1/4" Drive Socket Clips
 #8410 shown

Dura-Pro HD Socket Organizers ■

A traditional push/pull style socket clip providing a firm grip for impact and heavy sockets. ID stickers included.

Dimensions: 1/4" clips - 18.00"x 1.10"x .90" 3/8" clips - 18.00"x 1.10"x 1.00"
 1/2" clips - 18.00"x 1.10"x 1.20" Patent US 6,637,605



18" Socket Organizer w/ (22) 1/4" Drive Dura-Pro HD Socket Clips
#8322 Red-1/4"

18" Socket Organizer w/ (18) 3/8" Drive Dura-Pro HD Socket Clips
#8320 Red-3/8"

18" Socket Organizer w/ (17) 1/2" Drive Dura-Pro HD Socket Clips
#8321 Red-1/2"

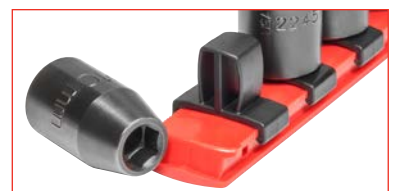

#8321 shown
 Tools not included

Magnetic Twist Lock Socket Organizers

MAGNETIC

With a simple twist, your sockets are firmly secured in a locked position. Twist in the reverse direction and your sockets are free to remove. Strong magnets used in our universal socket rails provide stability to keep your sockets upright in toolbox drawers. Works with or without drawer liners. ID stickers included. *Patents US 6,637,605, US 8,770,418*



18" Magnetic Socket Organizer w/ (22) 1/4" Drive Twist Lock Socket Clips
 #8400M Red-1/4" #8403M Blue-1/4" #8420M Black-1/4"

18" Magnetic Socket Organizer w/ (18) 3/8" Drive Twist Lock Socket Clips
 #8401M Red-3/8" #8404M Blue-3/8" #8421M Black-3/8"

18" Magnetic Socket Organizer w/ (17) 1/2" Drive Twist Lock Socket Clips
 #8402M Red-1/2" #8405M Blue-1/2" #8422M Black-1/2"

Dimensions: 18" Rail w/ 1/4" clips - 18.00"x 1.10"x .90"
 w/ 3/8" clips - 18.00"x 1.10"x .90" w/ 1/2" clips - 18.00"x 1.10"x 1.20"



13" Magnetic Socket Organizer w/ (15) 1/4" Drive Twist Lock Socket Clips
 #8414M Red-1/4" #8417M Blue-1/4" #8423M Black-1/4"

13" Magnetic Socket Organizer w/ (14) 3/8" Drive Twist Lock Socket Clips
 #8415M Red-3/8" #8418M Blue-3/8" #8424M Black-3/8"

13" Magnetic Socket Organizer w/ (11) 1/2" Drive Twist Lock Socket Clips
 #8416M Red-1/2" #8419M Blue-1/2" #8425M Black-1/2"

Dimensions: 13" Rail w/ 1/4" clips - 13.00"x 1.10"x .90"
 w/ 3/8" clips - 13.00"x 1.10"x .90" w/ 1/2" clips - 13.00"x 1.10"x 1.20"

8" Magnetic Socket Organizer w/ (9) 1/4" Drive Twist Lock Socket Clips
 #8410M Red-1/4" #8407M Blue-1/4" #8426M Black-1/4"

8" Magnetic Socket Organizer w/ (9) 3/8" Drive Twist Lock Socket Clips
 #8411M Red-3/8" #8408M Blue-3/8" #8427M Black-3/8"

8" Magnetic Socket Organizer w/ (7) 1/2" Drive Twist Lock Socket Clips
 #8412M Red-1/2" #8409M Blue-1/2" #8428M Black-1/2"

Dimensions: 8" Rail w/ 1/4" clips - 8.00"x 1.10"x .90"
 w/ 3/8" clips - 8.00"x 1.10"x .90" w/ 1/2" clips - 8.00"x 1.10"x 1.20"



18" Magnetic Socket Organizer
with 1/2" Drive Socket Clips
#8402M shown



13" Magnetic Socket Organizer
with 3/8" Drive Socket Clips
#8415M shown



8" Magnetic Socket Organizer
with 1/4" Drive Socket Clips
#8410M shown

Magnetic Stabilizers



Tools not included.

Pulls through drawer liner



Wall mount option



Ratchet & Extension Holders

Our Ratchet & Extension Holders securely hold a wide range of ratchets and extensions in the toolbox or on the go. Available in 1/4", 3/8" and 1/2" sizes. 2 piece sets. Available in black. **Dimensions:** Side Mount 1/4" - .44"x 1.15"x 1.15" Side Mount 3/8" - .5"x 3"x 1.56" Side Mount 1/2" - .65"x 3.07"x 1.67" Face Mount 1/4" - .44"x 1.1"x 1.3" Face Mount 3/8" - .5"x 1.7"x 1.75" Face Mount 1/2" - .65"x 1.8"x 1.87" Patents US 6,250,466, US 6,637,605



Side Mount Ratchet & Extension Holder

#8352 shown

Face Mount Ratchet & Extension Holder

#8355 shown

- #8351 1/4" Side Mount Ratchet & Extension Holder - Black
- #8352 3/8" Side Mount Ratchet & Extension Holder - Black
- #8353 1/2" Side Mount Ratchet & Extension Holder - Black
- #8354 1/4" Face Mount Ratchet & Extension Holder - Black
- #8355 3/8" Face Mount Ratchet & Extension Holder - Black
- #8356 1/2" Face Mount Ratchet & Extension Holder - Black



Socket Clip Packs

TWIST LOCK SOCKET CLIPS Our most versatile and rugged socket clip! With an easy 1/8 turn sockets are locked. Twist in the reverse direction and sockets are free to remove. Ideal for secure transport of sockets and toolbox storage. ID stickers included. **Dimensions:** 1/4" clip - .38"x 1.10"x .63" 3/8" clip - .38"x 1.10"x .78" 1/2" clip - .50"x 1.10"x .94" 3/4" clip - .76"x 1.10"x 1.17" Patent US 8,770,418



- #8440 Twist Lock 1/4" Socket Clips - 22 pack
- #8441 Twist Lock 3/8" Socket Clips - 18 pack
- #8442 Twist Lock 1/2" Socket Clips - 17 pack
- #8443 Twist Lock 3/4" Socket Clips - 5 pack



DURA-PRO HD SOCKET CLIPS A traditional push/pull style clip that provides a firm grip for impact and heavy sockets. ID stickers included with each pack. **Dimensions:** 1/4" clip - .38"x 1.10"x .64" 3/8" clip - .38"x 1.10"x .75" 1/2" clip - .50"x 1.10"x .94"



- #8345 1/4" Dura-Pro HD Socket Clips - 22 pack
- #8343 3/8" Dura-Pro HD Socket Clips - 18 pack
- #8344 1/2" Dura-Pro HD Socket Clips - 17 pack



RATCHET & EXTENSION ORGANIZERS

Ratchet & Extension Tray NEW

Fits a range of ratchets and extensions with rounded handles and holds up to 9 tools. Tools are held in place with security tabs and can be easily released when pulling tools out. Organize tools in the drawer and on the go. Handles on the tray provide transportability. The size of the tray matches up with the Ernst Socket Boss for uniform drawer organization. Made from impact resistant material. **Dimensions:** 19.63"x 4.63"x 1.00"



3/8" Ratchet & Extension Tray

#8372 shown

- #8372 3/8" Ratchet & Extension Tray - Red
- #8371 3/8" Ratchet & Extension Tray - Black



Tools not included

Bit Boss®

This universal tray provides massive storage in a compact space. Taper Lock holes allow for a wide range of bits. Unique design holds small bits upright, and longer bits lay down flat so everything fits in the drawer. Conquer the cluttered mess in your toolbox with the Bit Boss.

Dimensions: 14.90" x 3.60" x 1.20" Patent US 10,449,665

- #5710 90 Tool Bit Boss - Black
- #5720HV 90 Tool Bit Boss - HI-VIZ



90 Tool Bit Boss
#5710 shown

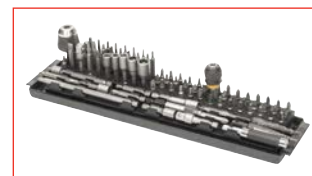

Tools not included

Bit Bar

Introducing the new Bit Bar! Featuring the same Taper Lock holes as the Bit Boss but with a magnetic base that holds strong, even on the side of the toolbox or upside down. 18" and 13" rails are available in multiple configurations to hold up to 96 bits. Long bits lay flat and short bits are held upright. Compact & convenient storage is great for in the box, mounted to the side, or on the go. Compatible with our Boss Series line (Page 8). Two color options available.

Dimensions: 18" length - 18.20" x 1.60" x 1.10"
13" length - 13.20" x 1.60" x 1.10"



- #5731 18" 60 tool Magnetic Bit Bar - Black/Red
- #5730 18" 78 tool Magnetic Bit Bar - Black/Red
- #5734 18" 96 tool Magnetic Bit Bar - Black/Red
- #5733HV 18" 60 tool Magnetic Bit Bar - HI-VIZ/Black
- #5732HV 18" 78 tool Magnetic Bit Bar - HI-VIZ/Black
- #5735HV 18" 96 tool Magnetic Bit Bar - HI-VIZ/Black



- #5740 13" 54 tool Magnetic Bit Bar - Black/Red
- #5741 13" 72 tool Magnetic Bit Bar - Black/Red
- #5742HV 13" 54 tool Magnetic Bit Bar - HI-VIZ/Black
- #5743HV 13" 72 tool Magnetic Bit Bar - HI-VIZ/Black



18" 60 tool Magnetic Bit Bar
#5731 shown



18" 78 tool Magnetic Bit Bar
#5730 shown



18" 96 tool Magnetic Bit Bar
#5734 shown



13" 54 tool Magnetic Bit Bar
#5740 shown



13" 72 tool Magnetic Bit Bar
#5741 shown

Bit Buddy

The Bit Buddy is a great grab-and-go organizer for your essential bit sets. The 8" compact size is easy for storage and has a strong magnetic mount that holds strong to metal surfaces. Medium and long bits lay flat and short bits are held upright, holding a total up to 30. Two color options available. **Dimensions:** 8.20" x 1.60" x 1.10"

- #5750 8" 30 tool Magnetic Bit Buddy - Black/Red
- #5751HV 8" 30 tool Magnetic Bit Buddy - HI-VIZ/Black



8" 30 tool Magnetic Bit Buddy
#5750 shown

Gripper Wrench Organizers

Gripper Wrench Organizers help you organize your wrenches, and securely transport wrenches to the job site.

These superior organizers provide the ultimate in tool box storage. They accommodate a wide variety of wrenches and allow for immediate recognition of a missing wrench.

Our Wrench Organizers are made from soft, flexible material. While holding wrenches secure for transportation, they also allow for easy one-handed engagement and removal of wrenches.

Patent US 5,638,964



#5046 shown
Tools not included



Transportable – holds tools securely!



Place wrenches in unlocked position for easy access

Visual observation of missing wrenches



Wall mount feature for added versatility

Tools not included.



<https://youtu.be/RkiJfBGPz0>

- Durable, flexible teeth
- Easy wrench removal
- Fits most wrenches
- Folding space saver handle
- Soft non-marring material
- Fuel and solvent resistant

Gripper Wrench Organizers

4 tool gripper Holds 3/8"-9/16" and 10-13 mm Dimensions: 5.27" x 4.31" x 1.45"

#5040 Red #5041 Black

5 tool gripper Holds 1/4"-1/2" and 6-10 mm Dimensions: 5.61" x 4.34" x 1.38"

#5042 Red #5043 Black

6 tool gripper Holds 1/4"-9/16" and 6-11 mm Dimensions: 6.18" x 4.27" x 1.22"

#5044 Red #5045 Black

7 tool gripper Holds 1/4"-5/8" and 6-12 mm Dimensions: 6.25" x 4.19" x 1.20"

#5080 Red #5081 Black

8 tool gripper Holds 1/4"-3/4" and 6-15 mm Dimensions: 7.87" x 4.94" x 1.41"

#5046 Red #5047 Black

9 tool gripper Holds 1/4"-3/4" and 6-15 mm Dimensions: 7.81" x 4.94" x 1.49"

#5084 Red #5085 Black

10 tool gripper Holds 1/4"-7/8" and 6-15 mm Dimensions: 9.68" x 5.71" x 1.56"

#5048 Red #5049 Black

11 tool gripper Holds 1/4"-7/8" and 6-16 mm Dimensions: 9.68" x 5.75" x 1.56"

#5086 Red #5087 Black #5083HV HI-VIZ

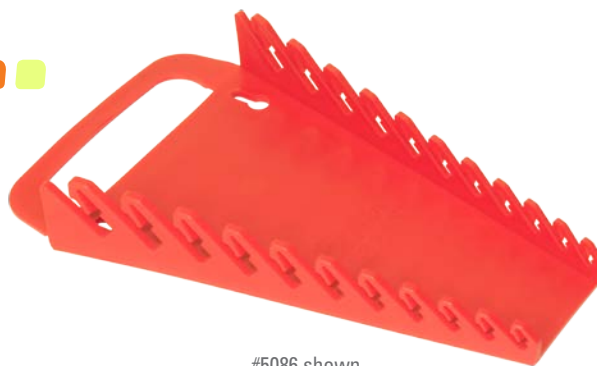

#5086 shown

12 tool gripper Holds 1/4"-15/16" and 6-18 mm Dimensions: 11.06" x 6.25" x 1.72"

#5015 Red #5016 Black

13 tool gripper Holds 1/4"-1" and 6-19 mm Dimensions: 11.56" x 6.62" x 1.68"

#5013 Red #5014 Black

14 tool gripper Holds 1/4"-1 1/8" and 6-20 mm Dimensions: 12.12" x 6.75" x 1.71"

#5037 Red #5038 Black **NEW**

15 tool gripper Holds 1/4"-1 1/8" and 6-20 mm Dimensions: 13.62" x 7.50" x 1.88"

#5088 Red #5089 Black #5082HV HI-VIZ

#5056 Green #5057 Orange #5055 Blue

Gripper Stubby Wrench Organizers

5 tool stubby gripper Holds 20-24 mm Dimensions: 6.87" x 2.26" x 1.88"

#5070 Red #5071 Black

7 tool stubby gripper Holds 3/8"-3/4" Dimensions: 6.50" x 2.26" x 1.32"

#5072 Red #5073 Black

10 tool stubby gripper Holds 10-19 mm Dimensions: 9.18" x 2.26" x 1.58"

#5074 Red #5075 Black

11 tool stubby gripper Holds 3/8"-1" Dimensions: 10.18" x 2.26" x 1.61"

#5076 Red #5077 Black #5078HV HI-VIZ

14 tool stubby gripper Holds 6-19 mm Dimensions: 11.81" x 2.33" x 1.70"

#5092 Red #5093 Black **NEW**

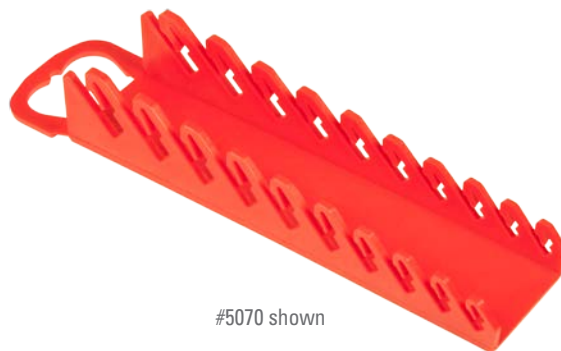

#5070 shown

Gripper Reverse Wrench Organizers

8 tool reverse gripper Holds 1/4"-3/4" and 6-15 mm Dimensions: 6.93" x 4.56" x 1.38"

#5146 Red #5147 Black

12 tool reverse gripper Holds 1/4"-15/16" and 6-18 mm Dimensions: 10.25" x 6.00" x 1.54"

#5115 Red #5116 Black

15 tool reverse gripper Holds 1/4"-1 1/8" and 6-20 mm Dimensions: 12.81" x 7.12" x 1.88"

#5188 Red #5189 Black #5182HV HI-VIZ

#5156 Green #5157 Orange #5155 Blue



#5188 shown

Wrench Tool Towers

The Tool Tower with the Ernst “Gripper” tooth provides it all: vertical, compact, and portable wrench storage. Rubberized foot pegs are slip resistant and ensure a stable base. The handle provides comfortable portability to take your wrenches from one workstation to the next. Secure locking grip keeps your wrenches safe, even on the go. Two sided storage accommodates both SAE and Metric wrench storage.

Dimensions: 24 Tool - 10.62”x 6.25”x 5.43” 30 Tool - 13.00”x 7.25”x 5.50”
 Patent US 5,638,964

#5224 24 Tool Wrench Tool Tower - Red

#5230 30 Tool Wrench Tool Tower - Red



24 Tool Wrench Tool Tower



30 Tool Wrench Tool Tower

Tools not included

Wrench Organizer Trays

Our Wrench Organizer Tray is ideal for toolbox storage. Wrenches are lined up and easily accessible. Simply pick tools and place them back without resistance. Perfect when working in any garage environment. Fuel and solvent resistant. Holds up to 19 wrenches.

Dimensions: 11 Tool - 8.37” x 6.12” x 1.29” 13 Tool - 9.25” x 6.12” x 1.28”
 14 Tool - 10.37” x 6.62” x 1.35” 15 Tool - 10.75” x 6.56” x 1.35”
 16 Tool - 12.31” x 7.37” x 1.34” 19 Tool - 15.56” x 8.75” x 1.57”
 16 Tool Reverse - 12.31” x 7.37” x 1.38”

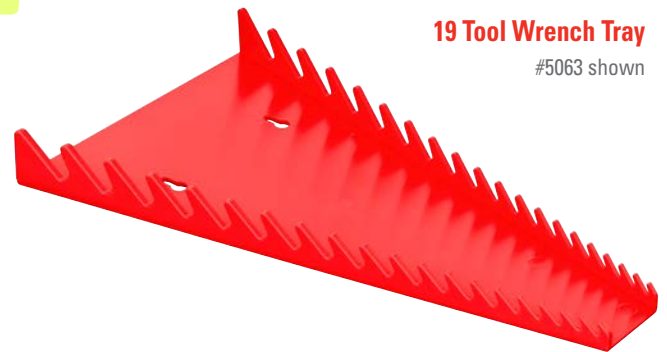

19 Tool Wrench Tray

#5063 shown

- NEW** #5035 11 Tool Wrench Tray - Red
- NEW** #5036 11 Tool Wrench Tray - Black
- #5030 13 Tool Wrench Tray - Red
- #5031 13 Tool Wrench Tray - Black
- #5032HV 13 Tool Wrench Tray - HI-VIZ
- NEW** #5033 14 Tool Wrench Tray - Red
- NEW** #5034 14 Tool Wrench Tray - Black
- #5066 15 Tool Wrench Tray - Red
- #5067 15 Tool Wrench Tray - Black
- #5068HV 15 Tool Wrench Tray - HI-VIZ

- #5060 16 Tool Wrench Tray - Red
- #5061 16 Tool Wrench Tray - Black
- #5050 16 Tool Wrench Tray - Blue
- #5051 16 Tool Wrench Tray - Green
- #5052 16 Tool Wrench Tray - Orange
- #5062HV 16 Tool Wrench Tray - HI-VIZ
- #5063 19 Tool Wrench Tray - Red
- #5064 19 Tool Wrench Tray - Black
- #5065HV 19 Tool Wrench Tray - HI-VIZ
- #5160 16 Tool Reverse Wrench Tray - Red
- #5161 16 Tool Reverse Wrench Tray - Black
- #5151 16 Tool Reverse Wrench Tray - Green
- #5152 16 Tool Reverse Wrench Tray - Orange
- #5162HV 16 Tool Reverse Wrench Tray - HI-VIZ

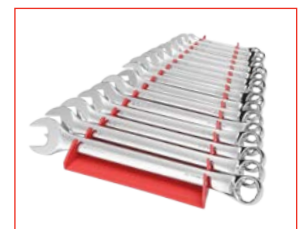

16 Tool Reverse Wrench Tray

#5160 shown
 Tools not included

No-slip Low Profile Wrench Rails

High grip rubberized rails keep tools in place. The unique low profile design accommodates wrench storage in shallow drawers. All your wrenches can face forward in a uniform row for easy identification of sizes and any missing tools. Comes with two forward and two reverse rails to maximize space usage of your drawers.

Dimensions: 15.75"x .90"x .82" per piece

#6050 30 Tool Low Profile Wrench Rail Set - Red

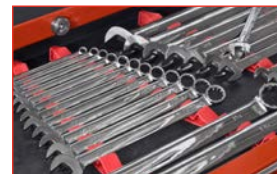

Tools not included

Wrench Rail Organizers

20 TOOL 2-piece Wrench Rails hold up to 20 wrenches, and are ideal for use in toolbox drawers. Graduated teeth provide maximum wrench storage. More tools per square inch than the competition! Trims easily for a custom fit. Available with magnetic tape. Fuel and solvent resistant.

Dimensions: 16.00"x .80"x 2.00" per piece Patent US 6,039,178

40 TOOL SPACE SAVER Wrench Rail Organizers maximize space, using a staggered rail design with forward and reverse teeth which allows for more wrenches per square inch. Graduated teeth provide maximum wrench storage - 40 wrenches, all held at the same viewing angle. Available with magnetic tape. Fuel and solvent resistant.

Dimensions: 16.00"x .80"x 2.00" per piece Patent US 6,039,178

- #6012 20 Tool Wrench Rail Set - Red
- #6013 20 Tool Wrench Rail Set - Black
- #6012M 20 Tool Wrench Rail Set w/Magnet- Red
- #6013M 20 Tool Wrench Rail Set w/Magnet- Black
- #6014 40 Tool Space Saver Wrench Rail Set - Red
- #6015 40 Tool Space Saver Wrench Rail Set - Black
- #6014M 40 Tool Space Saver Wrench Rail Set w/Magnet - Red
- #6015M 40 Tool Space Saver Wrench Rail Set w/Magnet - Black

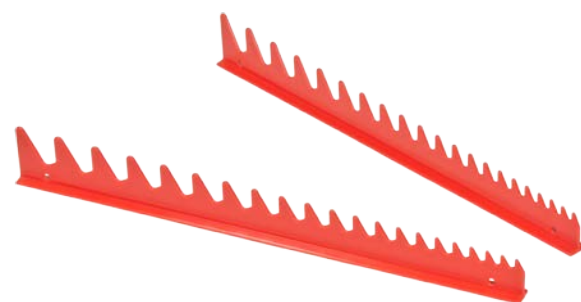

available in
MAGNETIC

20 Tool Wrench Rail Set

#6012 shown

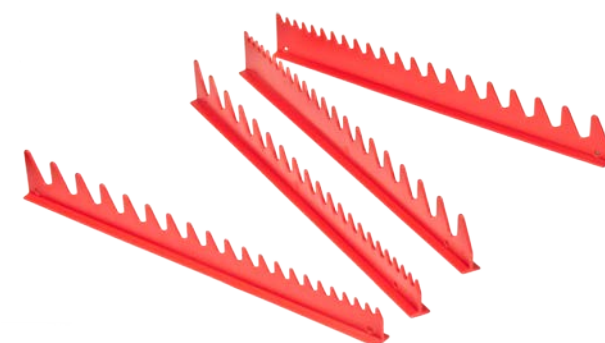

40 Tool Space Saver Wrench Rail Set

#6014 shown

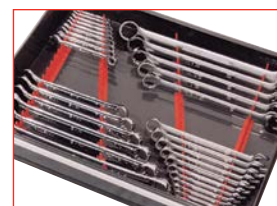

Tools not included

Wrench Pro **NEW**

The new Wrench Pro is a versatile wrench organizer designed to save valuable space in the toolbox by storing wrenches upright to fit more tools in compact spaces. The modular design is very easy to set up and break apart for custom wrench sets and holds any number of tools needed in one section. Fits a wide range of sizes and wrench types. Identification labels are included so you can easily see wrench sizes and spot missing tools. Cleats sink into drawer liner and prevent movement when drawers are opened and closed. Magnetic options are available to provide an even more secure drawer mount.

Dimensions: 40 Tool - 15.5" x 2.25" x 1.63" per set assembled
 20 Tool - 15.50" x 2.25" x 1.63" assembled Triple Tab - 2.40" x 2.25" x 1.63" Single Tab - .95" x 2.25" x 1.63" Patent pending

40 Tool Modular Wrench Pro

- #5412 Red #5410 Black #5414 Blue
- #5416 Green #5418 HI-VIZ

40 Tool Magnetic Modular Wrench Pro

- #5413M Red #5411M Black #5415M Blue
- #5417M Green #5419M HI-VIZ

20 Tool Modular Wrench Pro

- #5402 Red #5400 Black #5404 Blue
- #5406 Green #5408 HI-VIZ

20 Tool Magnetic Modular Wrench Pro

- #5403M Red #5401M Black #5405M Blue
- #5407M Green #5409M HI-VIZ

Triple Tab Modular Wrench Pro

- #5426 Red #5424 Black #5430 Blue
- #5434 Green #5438 HI-VIZ

Triple Tab Magnetic Modular Wrench Pro

- #5427M Red #5425M Black #5431M Blue
- #5435M Green #5439M HI-VIZ

Single Tab Modular Wrench Pro

- #5422 Red #5420 Black #5428 Blue
- #5432 Green #5436 HI-VIZ

Single Tab Magnetic Modular Wrench Pro

- #5423M Red #5421M Black #5429M Blue
- #5433M Green #5437M HI-VIZ

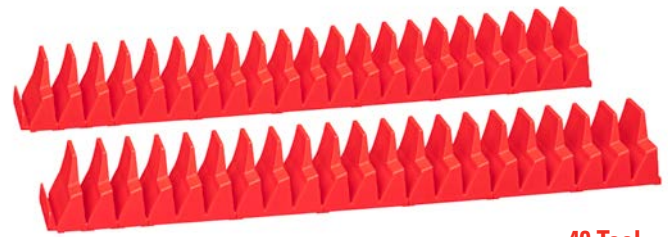

40 Tool Wrench Pro
#5412 shown

available in
MAGNETIC



Tools not included



20 Tool Wrench Pro
#5402 shown



Single Tab Wrench Pro
#5422 shown



Triple Tab Wrench Pro
#5426 shown



Single Tab Magnetic Wrench Pro
#5423M shown



#5500 shown
Tools not included

Plier Pro®



Maximize your storage by organizing pliers upright in toolbox drawers! The premium black rubber base on this rack grips tools and the drawer to keep it all in place. Accommodates a wide variety of tools, holding a total of 10. Immediate recognition of missing tools. How many can you fit in your drawer? **Dimensions:** 10.00"x 3.70"x 2.70" Patents US D816,378S, US10,500,712

- #5500 10 Tool Plier Pro - Red
- #5501 10 Tool Plier Pro - Green
- #5502 10 Tool Plier Pro - Orange
- #5505HV 10 Tool Plier Pro - HI-VIZ

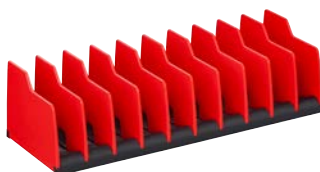

<https://youtu.be/eWCbBSaDq4U>

High grip rubber floor



Maximize drawer space



No-slip Low Profile Screwdriver Rails

High-grip rubberized material eliminates the need for expensive magnets. Perfect fit for shallow drawers. Holds 14 screwdrivers. Comes with two 15-1/2" rails for standard toolbox drawers. Trims down easily for custom fit if needed. Available in red.

Dimensions: 16.00" x .90" x .90" per piece

#6040 14 Tool Low Profile Screwdriver Rail Set - Red

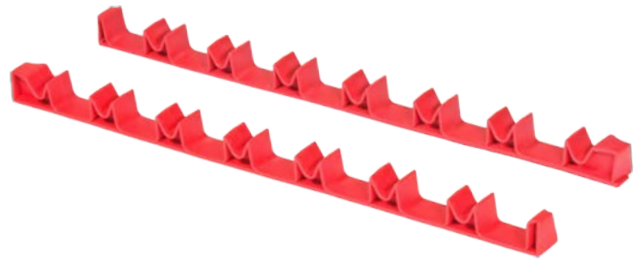

Tools not included

Screwdriver Rail Organizers

available in

MAGNETIC

Our 3 piece rails hold up to 20 screwdrivers per set, and are ideal for toolbox drawers. Trims easily for a custom fit. Also available with magnetic tape! Fuel and solvent resistant.

Dimensions: 15.80" x .75" x 1.50" per piece

Patent US D415,913

#6010 20 Tool Screwdriver Rail Set - Red

#6011 20 Tool Screwdriver Rail Set - Black

#6010M 20 Tool Screwdriver Rail Set w/Magnet - Red

#6011M 20 Tool Screwdriver Rail Set w/Magnet - Black

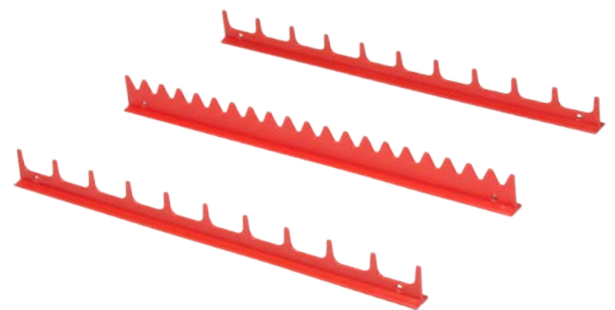

#6010 shown
Tools not included

V-SLOT™ Screwdriver Organizer

Perfect for pegboard! Organize your garage or workspace with the V-Slot Screwdriver organizer. Designed for use on all common pegboard sizes. The Patented "V" Slot securely holds a wide variety of tools. Tools tilt slightly for added stability on the wall. **Dimensions:** 10.75" x 2.50" x 1.50" Patent US 9,597,791

#5350 8 Tool V-Slot Screwdriver Organizer - Gray

#5353 V-Slot Screwdriver Organizer - 3 pack - Gray

#5355HV 8 Tool V-Slot Screwdriver Organizer - HI-VIZ

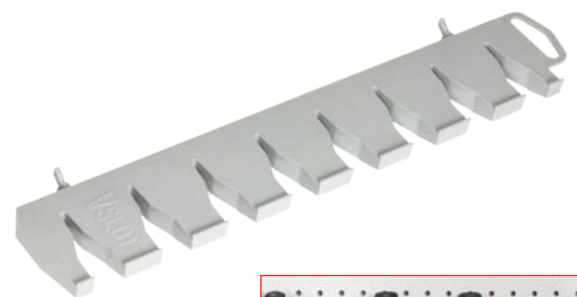

#5350 shown
Tools not included

Screwdriver Grippers ■ ■

These Screwdriver Grippers are a must have for any tool user. Transport and store your screwdrivers with ease. Our unique gripping teeth secure the shafts of screwdrivers to accommodate a very wide range of sizes. Use on the go, in toolbox drawers, and on pegboard. Available in 10 tool, 8 tool and 6 tool. The 10 and 8 tools include an insert for two stubby screwdrivers. Available in red and black.

Dimensions: 10 Tool - 10.87"x 2.43"x 1.63"

8 Tool - 7.50"x 2.43"x 1.63" 6 Tool - 7.50"x 2.43"x 1.63"

#5310 10 Tool Screwdriver Gripper - Red

#5311 10 Tool Screwdriver Gripper - Black

#5308 8 Tool Screwdriver Gripper - Red

#5306 6 Tool Screwdriver Gripper - Red



<https://youtu.be/B2vv8MTazZk>

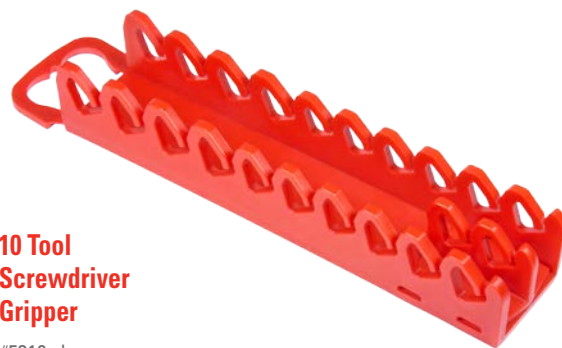

**10 Tool
Screwdriver
Gripper**

#5310 shown



**6 Tool
Screwdriver
Gripper**

#5306 shown



#5310 shown
Tools not included

Screwdriver Organizer Trays ■ ■

Organize your toolbox! Our 12 Tool Screwdriver Organizer is ideal for toolbox storage. Fuel and solvent resistant. **Dimensions:** 12.30"x 7.50"x 1.50"
Patent US D392,489

#5090 12 Tool Screwdriver Organizer Tray - Red

#5091 12 Tool Screwdriver Organizer Tray - Black

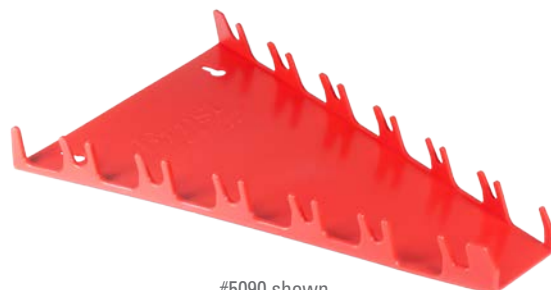

#5090 shown

Tool Organizer Pro Pack ■

A premium selection of best sellers now in one easy pack. Give your sockets, wrenches, screwdrivers, and pliers all a place to go home with this set. Features Socket Boss with Twist Lock Socket Clips, and no-slip material used for Low Profile Wrench and Screwdriver Rails and Plier Organizers. Fuel resistant 10 compartment tray will fit in shallow toolbox drawers.

Includes a 3 Rail Socket Boss for 1/4", 3/8", and 1/2" drives, 30 Tool Low Profile Wrench Rails, 14 Tool Low Profile Screwdriver Rails, 10 Tool Plier Pro® and 10 Compartment Tray. Patent US D816,378S, US 6,637,605, US 8,770,418, D725,993S, US 9,364,949



#8500 Tool Organizer Pro Pack - Red

Gripper Wrench Organizer Pack ■■

A natural pairing of gripper wrench organizers available in a pack. Forward and reverse designs save space when placed side by side and all wrenches neatly face the same direction. Two colors can provide visual differentiation of SAE and Metric Sockets. Securely holds 30 Wrenches.



#8540 Forward/Reverse Gripper Wrench Pack - Red/Black

Wrench Organizer Tray Packs ■■

Wrench organizer trays now available in packs. Two colors provide visual differentiation of SAE and Metric Sockets. Options of having two forward facing racks or a forward and reverse combination. Holds 32 Wrenches.



#8530 Wrench Tray Pack - Red/Black

#8531 Forward/Reverse Wrench Tray Pack - Red/Black

Tray Organizers ■ ■ ■ ■ ■ ■

Find a place for everything in your toolbox (or anywhere else!) with our impact resistant tray organizers. Available in 2 convenient sizes. Will fit shallow drawers in standard tool boxes. Rounded corners for easy removal of small parts. Stackable and fuel and solvent resistant.

Dimensions: 3 Compartment - 10.50"x 10.50"x 1.40"

10 Compartment - 16.00"x 11.00"x 1.40"

#5010	11 x 16 Ten Compartment Organizer Tray - Red
#5011	11 x 16 Ten Compartment Organizer Tray - Black
#5012	11 x 16 Ten Compartment Organizer Tray - Blue
#5018	11 x 16 Ten Compartment Organizer Tray - Green
#5019	11 x 16 Ten Compartment Organizer Tray - Orange
#5017HV	11 x 16 Ten Compartment Organizer Tray - HI-VIZ
#5020	10.5 x 10.5 Three Compartment Organizer Tray - Red
#5021	10.5 x 10.5 Three Compartment Organizer Tray - Black
#5022	10.5 x 10.5 Three Compartment Organizer Tray - Blue
#5024	10.5 x 10.5 Three Compartment Organizer Tray - Green
#5025	10.5 x 10.5 Three Compartment Organizer Tray - Orange
#5023HV	10.5 x 10.5 Three Compartment Organizer Tray - HI-VIZ



11 x 16 Ten Compartment Organizer Tray

#5010 shown



10.5 x 10.5 Three Compartment Organizer Tray

#5020 shown

- **Rounded corners for easy part removal**
- **Fuel and solvent resistant**
- **Impact resistant**
- **Fits shallow toolbox drawers**

Toolbox storage



Stackable



Shop Chocks ■

Stop it! - with our high-grip wheel chocks. Works great on shop floors or lifts. Rubberized material provides extra slip resistance. Available in red. **Dimensions:** 9.00"x 5.00"x 3.50" per piece

#980 High Grip Shop Chocks – 2 pack – Red

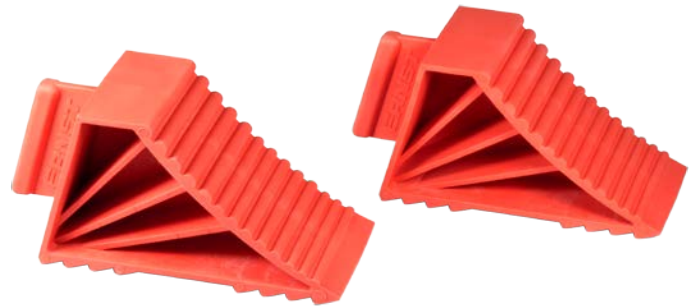

#980 shown
Tools not included

Greg's Oil Filter Funnel ■

Change the oil in your motorcycle without the headache of the mess! Fits all Harley Davidson® EVO & Twin Cam 1985 to present with forward mounted oil filter. For all current Harley Davidson® Touring, Dyna®, Softail®, Sportster® and forward control models. Keep oil from damaging your rubber engine mount. This superior U-shaped design fits the Harley like no other funnel can. This multipurpose funnel is also great for refilling fluids! Fits perfect in tight places for refilling your oil, transmission, and primary fluids.

Patents US D697,539, US 8,578,975

#960 Greg's Oil Filter Funnel - Orange



- Drain oil with NO MESS
- Fits most Harley models
- Hangtab for use on pegboards
- Doubles as a refill funnel
- Punch and drain tube extension – included for lower faring



https://youtu.be/17S6Yo_l6uw

Transmission

Refill fluids

Oil

Primary



Jack Stand Covers ■

Warning: Your jack stands may be missing an important piece. Using jack stands has always risked scratching your frame, marring powder coatings or your custom finish — and possibly leading to rust problems. Until now! Don't worry about rummaging around to find dirty old shop rags or scraps of wood to cover the tops of your jack stands. You've spent a lot of time and money on your vehicle. Help protect it with Ernst Jack Stand Covers.

Made of high-compression, rubberized material, these jack stand covers fit most two-ton to six-ton jack stands. **Dimensions:** 4.50" x 1.50" x 2.00" per piece

#965 Jack Stand Covers – 2 pack – Yellow

#964 Jack Stand Covers – 4 pack – Yellow



#964 shown
Tools not included

Ultra-Flex Wheel Protector ■ ■

Throw away those home-made cardboard wheel protectors. Introducing the Ultra-Flex Wheel Protector, a revolutionary tire care product that protects a wide range of wheels from tire sprays.

Works on 4 wheel sizes - 13", 14", 15" and 16". Simply squeeze the handle to accommodate smaller wheels, and push against the wheel to flare out for larger wheels - it's that easy! Made of durable plastic for long life.

Foam and spray wipes easily from its smooth plastic surface. **Dimensions:** 12.00" x 16.00" x 4.80"
Patent US 6,457,780

#975 16"-13" Ultra-flex Wheel Protector – Orange

#976 16"-13" Ultra-flex Wheel Protector – Green



#975 shown
Tools not included

COMBO PACKS

*Announcing our combo packs –
a selection of our best sellers
grouped for your ease!*

CHECK THEM OUT ON PAGES 7 & 21



#8500 shown.
Tools not included.

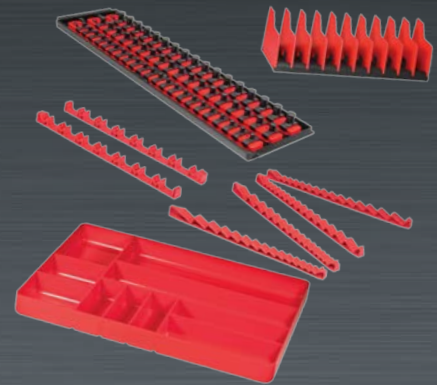

#8500 Tool Organizer
Pro Pack - Red **Page 21**

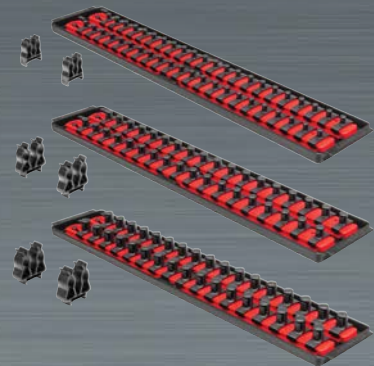

#8510 Socket Boss
Combo Pack - Red **Page 7**
Also available in blue and HI-VIZ



#8540 Forward/Reverse Gripper
Wrench Pack - Red/Black **Page 21**



#8530 Wrench Tray Pack -
Red/Black **Page 21**

#8531 Forward/Reverse Wrench
Tray Pack - Red/Black **Page 21**

LIKE WHAT YOU SEE?

BECOME A
PART OF



Stay social, keep up to date on new products, and get great discounts and ideas on how to organize like a boss. Like us today!



IT'S EASY! SIGN UP FOR OUR
EMAIL NEWSLETTER

*Full of new product releases,
events, deals, and everything else
you need to know to keep up to date.*



ERNSTMFG



ERNSTMFG



ERNSTMANUFACTURING



ERNSTMFG

ERNSTMFG.COM

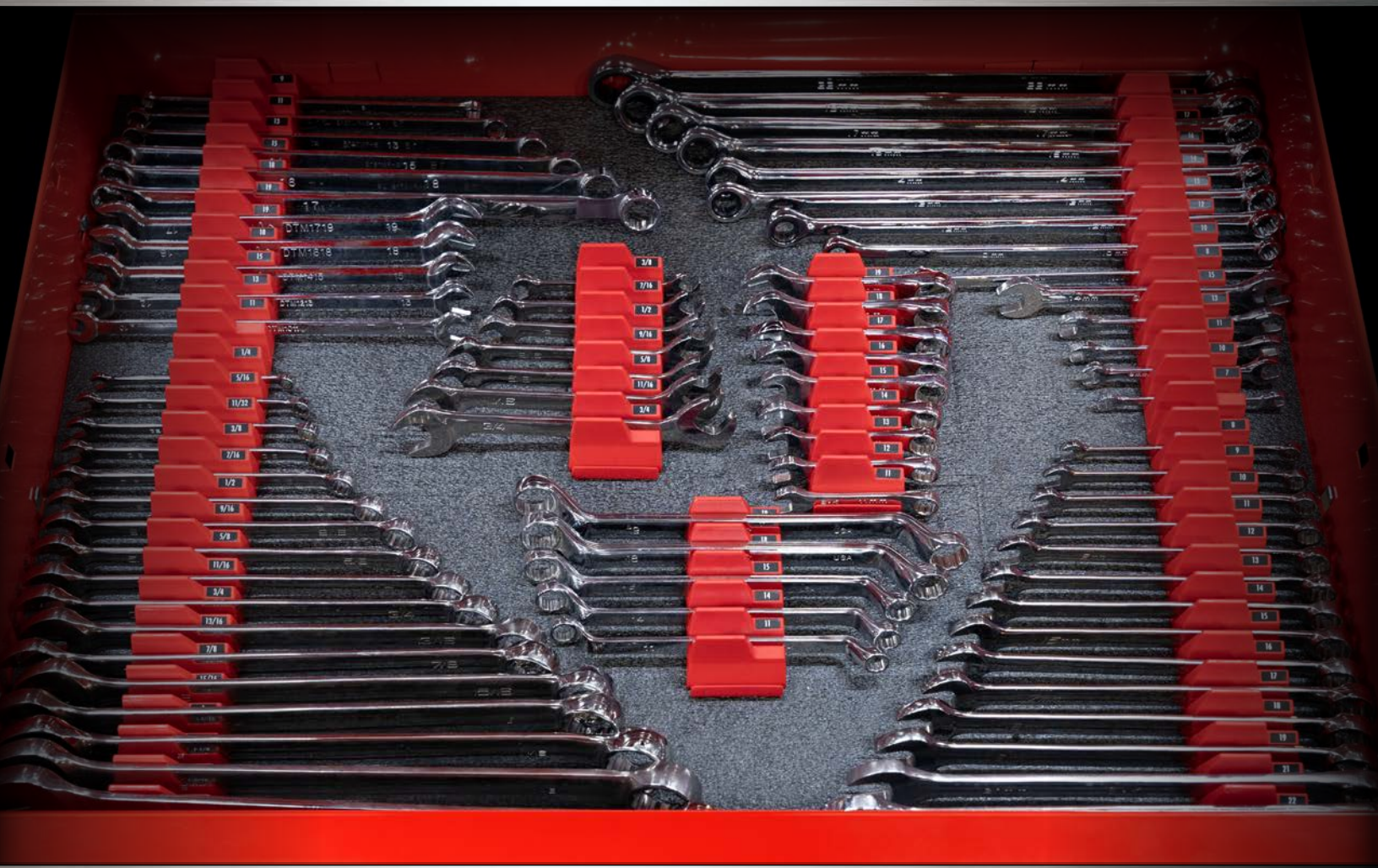

ERNST
MANUFACTURING INC.

37570 Ruben Lane, Sandy, OR 97055
Toll Free 877-ERNST-TL (877)-376-7885
Local (503) 668-5597
Fax (503) 668-5931

EMI 2024-1

