

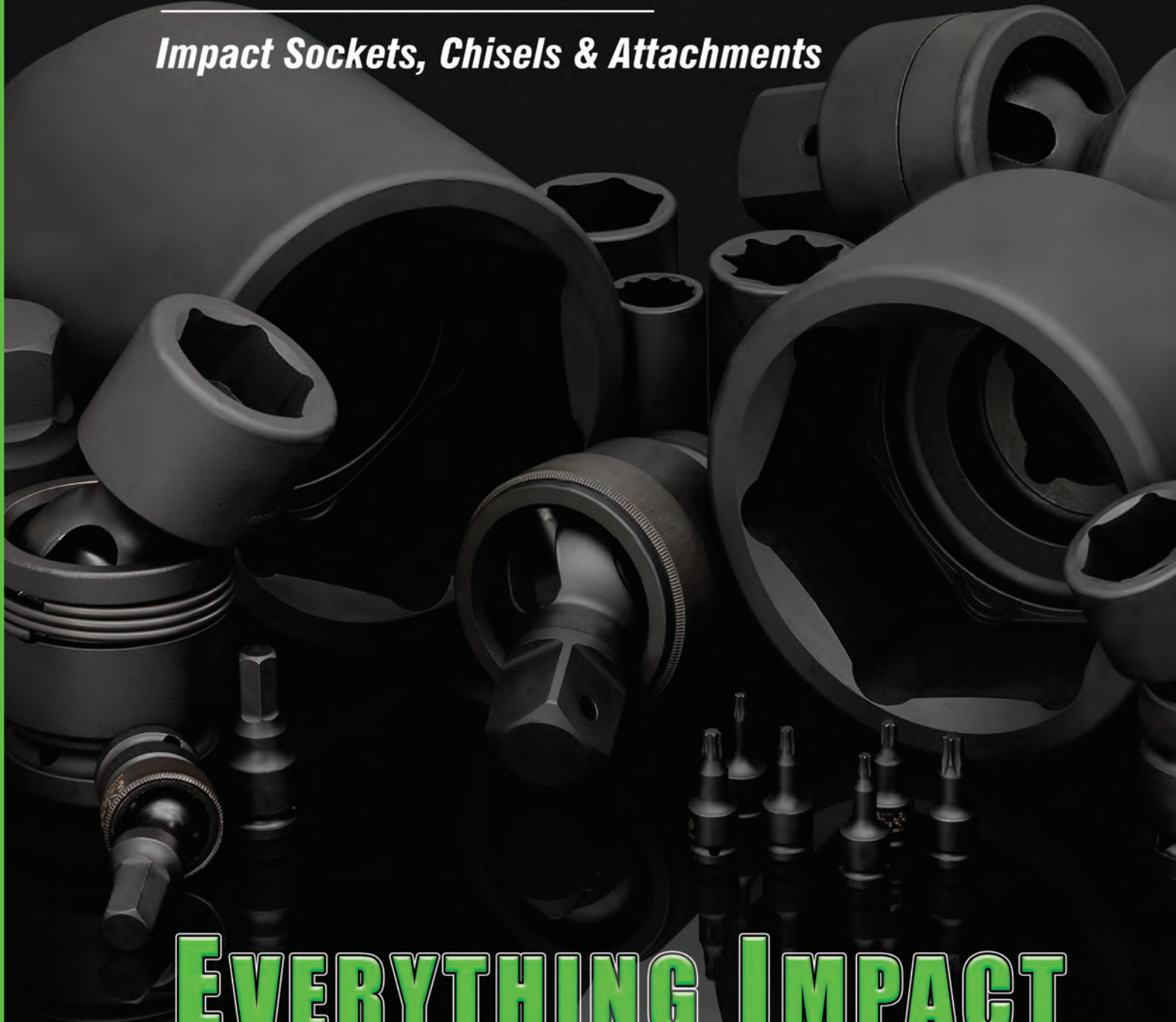

Grey Pneumatic

Product Catalog

Impact Sockets, Chisels & Attachments



EVERYTHING IMPACT.[®]



GP is **EVERYTHING IMPACT**®

Grey Pneumatic (GP) through our distributors supplies the world's automotive, industrial, assembly, mining, maintenance, construction, and energy industries with heavy duty, high quality impact and specialty sockets. We carry a complete line of Impact Socket sets and individuals from 1/4" drive thru 2-1/2" and #5 spline drive with hex sizes up to 8". We also offer a large selection of star impact drivers, impact hex drivers, triple square drivers, torque limiting extensions plus Impact chisels and accessories.

GP sockets and tools are made in Taiwan using the highest quality chrome-molybdenum alloy steel and state-of-the-art manufacturing processes and equipment. Thorough and exact heat treatment, as well as rigid quality control, ensures the correct balance of strength and durability to deliver outstanding performance at the most competitive cost.

GP Tools are available through Automotive and Industrial warehouse distributors, tool stores, mobile tool truck dealers, tire equipment and supply warehouses and other sources that service these markets.

GP offers **Fast and Reliable** service to all of our distributors and their customers.



*GP Tools carry a
Lifetime Warranty.*

All GP Impact Sockets feature the GP "High Torque" Drive

Benefits are:

Increased Strength - Transfers the pressure from the thinnest part of the socket wall toward the thicker section, resulting in increased strength.

Increased Torque - Allows up to 20% more torque to be applied than on standard hex impact sockets.

Easier Access to Tight Areas - The shift in pressure allows us to reduce the socket wall thickness, increasing access to tight areas.

Reduced Wear - Our impact sockets grip the fastener across a broader contact area, reducing the chance of rounding off fasteners.



*GP "High Torque"
drive offers many
benefits.*



*GP Sockets feature both
laser etched and roll
stamped size markings
for quick identification.*

EVERYTHING IMPACT®



1/4" Drive Impact Sockets	2	1/4"
3/8" Drive Impact Sockets	16	3/8"
1/2" Drive Impact Sockets	44	1/2"
3/4" Drive Impact Sockets	76	3/4"
1" Drive Impact Sockets	96	1"
1-1/2" Drive Impact Sockets	122	1-1/2"
2-1/2" Drive Impact Sockets	131	2-1/2"
#5 Spline Impact Sockets	136	#5 Spline
1/4" through 1/2" Drive 	140	DUO
Hex Drivers 1/4" through 1-1/2" Drive	149	HEX
Star Drivers 1/4" through 1/2" Drive	167	Star
Triple Square Drivers 3/8" through 1/2" Drive	175	Triple Square
Torque Limiting Impact Sockets and Extensions	181	Torque Limiting
Special Application	182	Specials
Wheel Service Items	184	Wheel Service
Impact Socket Displays	187	Displays
Impact Chisels for Pneumatic Hammers	194	Chisels



1/4" Drive Impact Socket Set



1/4"



No. 9772

1/4" Drive Master Set



This set contains the most popular sockets in our 1/4" surface drive line, plus 3 extensions, universal joint, 1/4" to 3/8" adapter and 1/4" Hex to 1/4" Square Adapter. Packaged in an all new compact, low profile molded storage case. This set is great for use on impact wrenches, air ratchets as well as hand ratchets.



72 piece set contents:

10 Pieces Standard Length:

3/16", 7/32", 1/4", 9/32", 5/16", 11/32", 3/8", 7/16", 1/2", 9/16"

10 Pieces Deep Length:

3/16", 7/32", 1/4", 9/32", 5/16", 11/32", 3/8", 7/16", 1/2", 9/16"

14 Pieces Metric Standard Length:

4mm, 4.5mm, 5mm, 5.5mm, 6mm, 7mm, 8mm, 9mm, 10mm, 11mm, 12mm, 13mm, 14mm, 15mm

14 Pieces Metric Deep Length:

4mm, 4.5mm, 5mm, 5.5mm, 6mm, 7mm, 8mm, 9mm, 10mm, 11mm, 12mm, 13mm, 14mm, 15mm

6 Pieces Standard Universal:

1/4", 5/16", 3/8", 7/16", 1/2", 9/16"

12 Pieces Metric Standard Universal:

5mm, 5.5mm, 6mm, 7mm, 8mm, 9mm, 10mm, 11mm, 12mm, 13mm, 14mm, 15mm

1 Piece Each:

2", 4", & 6" Extensions
1/4" Universal Joint
1/4" F. x 3/8" M. Adapter
1/4" Hex x 1/4" Square Adapter

Molded Storage Case





1/4" Drive Impact Socket Sets



6s

No. 9748

1/4" Drive Standard & Deep Length Master Set

SAE



1/4"



This set contains all standard and deep length sockets in both fractional and metric sizes. Packaged in a blow mold case for organized storage.



48 piece set contents:

10 Pieces Standard Length:

3/16", 7/32", 1/4", 9/32", 5/16", 11/32", 3/8", 7/16", 1/2", 9/16"

10 Pieces Deep Length:

3/16", 7/32", 1/4", 9/32", 5/16", 11/32", 3/8", 7/16", 1/2", 9/16"

14 Pieces Metric Standard Length:

4mm, 4.5mm, 5mm, 5.5mm, 6mm, 7mm, 8mm, 9mm, 10mm, 11mm, 12mm, 13mm, 14mm, 15mm

14 Pieces Metric Deep Length:

4mm, 4.5mm, 5mm, 5.5mm, 6mm, 7mm, 8mm, 9mm, 10mm, 11mm, 12mm, 13mm, 14mm, 15mm

Molded Storage Case

6s

No. 9728M

1/4" Drive Standard & Deep Length Metric Master Set



28 piece set contents:

14 Pieces Metric Standard Length:

4mm, 4.5mm, 5mm, 5.5mm, 6mm, 7mm, 8mm, 9mm, 10mm, 11mm, 12mm, 13mm, 14mm, 15mm

14 Pieces Metric Deep Length:

4mm, 4.5mm, 5mm, 5.5mm, 6mm, 7mm, 8mm, 9mm, 10mm, 11mm, 12mm, 13mm, 14mm, 15mm

Molded Storage Case





1/4" Drive Impact Socket Sets



1/4"

6s No. 9710 1/4" Drive Standard Length Fractional Set SAE



10 piece set contents:

906RS.....	3/16"	912RS.....	3/8"
907RS.....	7/32"	914RS.....	7/16"
908RS.....	1/4"	916RS.....	1/2"
909RS.....	9/32"	918RS.....	9/16"
910RS.....	5/16"		Molded Storage Case
911RS.....	11/32"		

6s No. 9710D 1/4" Drive Deep Length Fractional Set SAE



10 piece set contents:

906DS.....	3/16"	912DS.....	3/8"
907DS.....	7/32"	914DS.....	7/16"
908DS.....	1/4"	916DS.....	1/2"
909DS.....	9/32"	918DS.....	9/16"
910DS.....	5/16"		Molded Storage Case
911DS.....	11/32"		

6s No. 9714M 1/4" Drive Standard Length Metric Set MM



14 piece set contents:

904MS.....	.4mm	910MS.....	10mm
945MS.....	4.5mm	911MS.....	11mm
905MS.....	.5mm	912MS.....	12mm
955MS.....	5.5mm	913MS.....	13mm
906MS.....	.6mm	914MS.....	14mm
907MS.....	.7mm	915MS.....	15mm
908MS.....	.8mm		Molded Storage Case
909MS.....	.9mm		

6s No. 9714MD 1/4" Drive Deep Length Metric Set MM



14 piece set contents:

904MDS.....	.4mm	910MDS.....	10mm
945MDS.....	4.5mm	911MDS.....	11mm
905MDS.....	.5mm	912MDS.....	12mm
955MDS.....	5.5mm	913MDS.....	13mm
906MDS.....	.6mm	914MDS.....	14mm
907MDS.....	.7mm	915MDS.....	15mm
908MDS.....	.8mm		Molded Storage Case
909MDS.....	.9mm		



1/4" Drive Universal & Magnetic Impact Socket Sets



6s

No. 9706U 1/4" Drive Standard Length Fractional Universal Set

SAE

1/4"



6 piece set contents:

908US 1/4"	916US 1/2"
910US 5/16"	918US 9/16"
912US 3/8"	Molded Storage Case
914US 7/16"	

6s

No. 9712UM 1/4" Drive Standard Length Metric Universal Set

MM



12 piece set contents:

905UMS 5mm	911UMS 11mm
955UMS 5.5mm	912UMS 12mm
906UMS 6mm	913UMS 13mm
907UMS 7mm	914UMS 14mm
908UMS 8mm	915UMS 15mm
909UMS 9mm	Molded Storage Case
910UMS 10mm	

6s

No. 9712UMD 1/4" Drive Deep Length Metric Universal Set

MM



12 piece set contents:

905UMD 5mm	911UMD 11mm
955UMD 5.5mm	912UMD 12mm
906UMD 6mm	913UMD 13mm
907UMD 7mm	914UMD 14mm
908UMD 8mm	915UMD 15mm
909UMD 9mm	Molded Storage Case
910UMD 10mm	





1/4" Drive Magnetic Impact Socket Sets



1/4"

No. 9712UMG 1/4" Drive Standard Length Metric Magnetic Universal Set ▲ MM



12 piece set contents:

905UMG5mm	911UMG11mm
955UMG5.5mm	912UMG12mm
906UMG6mm	913UMG13mm
907UMG7mm	914UMG14mm
908UMG8mm	915UMG15mm
909UMG9mm		Molded Storage Case
910UMG10mm		



No. 9723G 1/4" Drive Standard Length Fractional & Metric Magnetic Set SAE ▲ MM



This set contains standard length, fractional and metric sizes along with an extension and universal joint packaged in a molded storage case. The powerful magnets hold any fastener securely. Great for use in impact or non-impact applications.

23 piece set contents:

906RG 3/16"	905MG5mm
907RG 7/32"	955MG 5.5mm
908RG 1/4"	906MG6mm
909RG 9/32"	907MG7mm
910RG 5/16"	908MG8mm
911RG 11/32"	909MG9mm
912RG 3/8"	910MG 10mm
914RG 7/16"	911MG 11mm
916RG 1/2"	912MG 12mm
	Molded Storage Case	913MG 13mm
		914MG 14mm
		915MG 15mm
		942E 2" Extension
		929UJ 1/4" x 1/4" Universal Joint





1/4" Drive Standard Length Impact Sockets



No. 9709G 1/4" Drive Standard Length Fractional Magnetic Set SAE



9 piece set contents:

906RG..... 3/16"	911RG..... 11/32"
907RG..... 7/32"	912RG..... 3/8"
908RG..... 1/4"	914RG..... 7/16"
909RG..... 9/32"	916RG..... 1/2"
910RG..... 5/16"	on a Metal Clip Rail

1/4"

No. 9712MG 1/4" Drive Standard Length Metric Magnetic Set MM



12 piece set contents:

905MG 5mm	910MG 10mm
955MG 5.5mm	911MG 11mm
906MG 6mm	912MG 12mm
907MG 7mm	913MG 13mm
908MG 8mm	914MG 14mm
909MG 9mm	915MG 15mm
	Molded Storage Case

No. 9709DG 1/4" Drive Deep Length Fractional Magnetic Set SAE



These Magnetic sockets feature a spring loaded magnet that retracts into the socket for extended bolt applications.



9 piece set contents:

906DG..... 3/16"	911DG..... 11/32"
907DG..... 7/32"	912DG..... 3/8"
908DG..... 1/4"	914DG..... 7/16"
909DG..... 9/32"	916DG..... 1/2"
910DG..... 5/16"	on a Metal Clip Rail

No. 9712MDG 1/4" Drive Deep Length Metric Magnetic Set MM



These Magnetic sockets feature a spring loaded magnet that retracts into the socket for extended bolt applications.



12 piece set contents:

905MDG 5mm	910MDG 10mm
955MDG 5.5mm	911MDG 11mm
906MDG 6mm	912MDG 12mm
907MDG 7mm	913MDG 13mm
908MDG 8mm	914MDG 14mm
909MDG 9mm	915MDG 15mm
	Molded Storage Case



1/4" Drive Standard Length Impact Sockets



Surface Drive Impact Sockets are specially designed with a hex opening that allows for quick engagement of a fastener. Ideal for assembly operations.

1/4"

6s 1/4" Drive - Standard Length - Fractional Sizes SAE



Item Number	Hex Size	Shape	Dimensions (Inches)				
			A	B	C	D	E
906RS	3/16"	I	.51	.33	.55	.24	.91
907RS	7/32"	I	.51	.37	.55	.24	.91
908RS	1/4"	I	.51	.41	.55	.28	.91
909RS	9/32"	I	.51	.44	.55	.28	.91
910RS	5/16"	I	.51	.49	.55	.35	.91
911RS	11/32"	II	.51	.54	.55	.35	.91
912RS	3/8"	II	.51	.59	.55	.35	.91
914RS	7/16"	II	.51	.64	.55	.35	.91
916RS	1/2"	II	.51	.74	.55	.35	.91
918RS	9/16"	II	.51	.79	.55	.35	.91

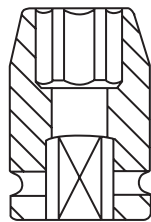

SHAPE I

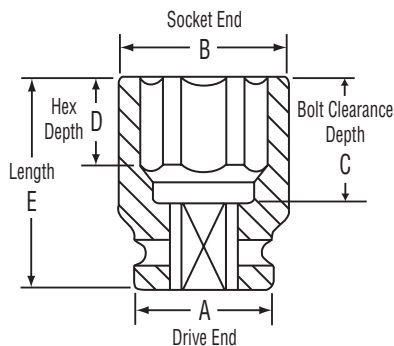

SHAPE II

6s Standard Length - Metric Sizes MM

Item Number	Hex Size	Shape	Dimensions (Millimeters)				
			A	B	C	D	E
904MS	4mm	I	13	7.6	14	4	23
945MS	4.5mm	I	13	8.2	14	6	23
905MS	5mm	I	13	8.8	14	6	23
955MS	5.5mm	I	13	9.5	14	6	23
906MS	6mm	I	13	10.0	14	7	23
907MS	7mm	I	13	11.3	14	7	23
908MS	8mm	I	13	12.5	14	9	23
909MS	9mm	II	13	13.8	14	9	23
910MS	10mm	II	13	15.0	14	9	23
911MS	11mm	II	13	16.3	14	9	23
912MS	12mm	II	13	17.0	14	9	23
913MS	13mm	II	13	18.8	14	9	23
914MS	14mm	II	13	20.0	14	9	23
915MS	15mm	II	13	21.0	14	9	23



1/4" Drive Deep Length Impact Sockets



Surface Drive Impact Sockets are specially designed with a hex opening that allows for quick engagement of a fastener. Ideal for assembly operations.

1/4"

6s 1/4" Drive - Deep Length - Fractional Sizes SAE



Item Number	Hex Size	Shape	Dimensions (Inches)				
			A	B	C	D	E
906DS	3/16"	I	.51	.34	1.61	.24	1.97
907DS	7/32"	I	.51	.37	1.61	.24	1.97
908DS	1/4"	I	.51	.41	1.61	.28	1.97
909DS	9/32"	I	.51	.44	1.61	.28	1.97
910DS	5/16"	I	.51	.49	1.61	.35	1.97
911DS	11/32"	II	.51	.54	1.61	.35	1.97
912DS	3/8"	II	.51	.59	1.61	.35	1.97
914DS	7/16"	II	.51	.64	1.61	.35	1.97
916DS	1/2"	II	.51	.74	1.61	.35	1.97
918DS	9/16"	II	.51	.79	1.61	.35	1.97

6s Deep Length - Metric Sizes

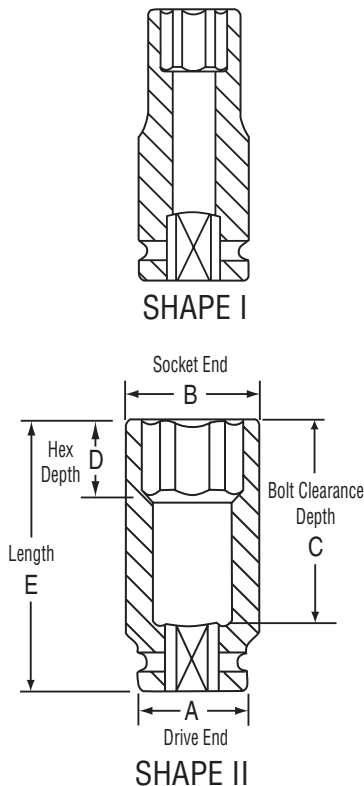

Item Number	Hex Size	Shape	Dimensions (Millimeters)				
			A	B	C	D	E
904MDS	4mm	I	13	7.6	41	4	50
945MDS	4.5mm	I	13	8.2	41	6	50
905MDS	5mm	I	13	8.8	41	6	50
955MDS	5.5mm	I	13	9.5	41	6	50
906MDS	6mm	I	13	10.0	41	7	50
907MDS	7mm	I	13	11.3	41	7	50
908MDS	8mm	I	13	12.5	41	9	50
909MDS	9mm	II	13	13.8	41	9	50
910MDS	10mm	II	13	15.0	41	9	50
911MDS	11mm	II	13	16.3	41	9	50
912MDS	12mm	II	13	17.0	41	9	50
913MDS	13mm	II	13	18.8	41	9	50
914MDS	14mm	II	13	20.0	41	9	50
915MDS	15mm	II	13	21.0	41	9	50



1/4" Drive Universal Impact Sockets



Surface Drive Impact Sockets are specially designed with a hex opening that allows for quick engagement of a fastener. Ideal for assembly operations.

1/4"



1/4" Drive - Standard Length Universal - Fractional Sizes



Item Number	Hex Size	Dimensions (Inches)			
		A	B	C	E
908US	1/4"	.59	.43	.28	1.69
910US	5/16"	.59	.49	.35	1.69
912US	3/8"	.59	.59	.35	1.69
914US	7/16"	.59	.65	.35	1.69
916US	1/2"	.63	.74	.35	1.89
918US	9/16"	.63	.78	.35	1.89



Standard Length Universal - Metric Sizes

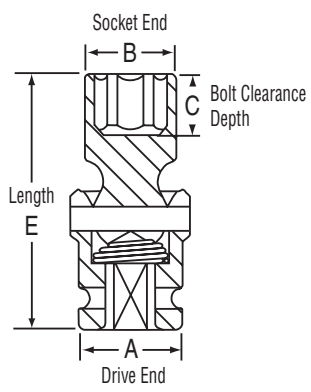

Item Number	Hex Size	Dimensions (Millimeters)			
		A	B	C	E
905UMS	5mm	15	8.8	6	43
955UMS	5.5mm	15	9.5	6	43
906UMS	6mm	15	10.0	7	43
907UMS	7mm	15	11.5	7	43
908UMS	8mm	15	12.5	9	43
909UMS	9mm	15	14.0	9	43
910UMS	10mm	15	15.0	9	43
911UMS	11mm	15	16.5	9	43
912UMS	12mm	16	16.8	9	48
913UMS	13mm	16	18.8	9	48
914UMS	14mm	16	19.8	9	48
915UMS	15mm	16	20.8	9	48



1/4" Drive Deep Length Universal Impact Sockets



Surface Drive Impact Sockets are specially designed with a hex opening that allows for quick engagement of a fastener. Ideal for assembly operations.

1/4"

6s 1/4" Drive - Deep Length Universal - Metric Sizes



Item Number	Hex Size	Dimensions (Millimeters)				
		A	B	C	D	E
905UMD	5mm	15	8.8	18	6	63
955UMD	5.5mm	15	9.5	20	6	63
906UMD	6mm	15	10.0	20	7	63
907UMD	7mm	15	11.5	20	7	63
908UMD	8mm	15	12.5	30	9	63
909UMD	9mm	15	14.0	30	9	63
910UMD	10mm	15	15.0	30	9	63
911UMD	11mm	15	16.5	30	9	63
912UMD	12mm	16	16.8	30	9	68
913UMD	13mm	16	18.8	30	9	68
914UMD	14mm	16	19.8	30	9	68
915UMD	15mm	16	20.8	30	9	68

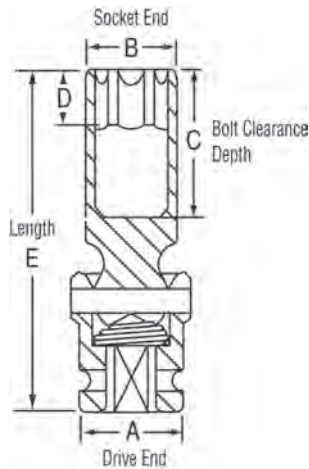



1/4" Drive Standard Length Magnetic Impact Sockets



1/4"

1/4" Drive Magnetic - Standard Length - Fractional Sizes SAE

Magnetic



Item Number	Hex Size	Shape	Dimensions (Inches)			
			A	B	D	E
906RG	3/16"	I	.51	.33	.12	.91
907RG	7/32"	I	.51	.37	.12	.91
908RG	1/4"	I	.51	.41	.12	.91
909RG	9/32"	I	.51	.44	.12	.91
910RG	5/16"	I	.51	.49	.12	.91
911RG	11/32"	III	.51	.54	.16	.91
912RG	3/8"	III	.51	.59	.16	.91
914RG	7/16"	III	.51	.64	.20	.91
916RG	1/2"	III	.51	.74	.20	.91

Standard Length - Metric Sizes MM

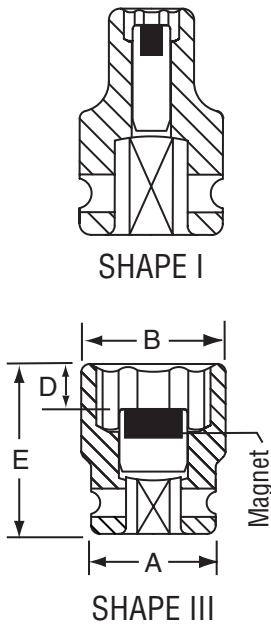

Item Number	Hex Size	Shape	Dimensions (Millimeters)			
			A	B	D	E
905MG	5mm	I	13	8.8	3.0	23
955MG	5.5mm	I	13	9.5	3.0	23
906MG	6mm	I	13	10.0	3.0	23
907MG	7mm	I	13	11.3	3.0	23
908MG	8mm	I	13	12.5	3.0	23
909MG	9mm	III	13	13.8	4.0	23
910MG	10mm	III	13	15.0	4.0	23
911MG	11mm	III	13	16.3	5.0	23
912MG	12mm	III	13	17.0	5.0	23
913MG	13mm	III	13	18.8	5.0	23
914MG	14mm	III	13	20.0	5.5	23
915MG	15mm	III	13	21.0	5.5	23



1/4" Drive Deep Length Magnetic Impact Sockets



All deep Magnetic sockets feature a spring loaded magnet that retracts into the socket for extended bolt applications.



1/4" Drive Magnetic - Deep Length - Fractional Sizes

SAE

1/4"



Item Number	Hex Size	Shape	Dimensions (Inches)				
			A	B	C	D	E
906DG	3/16"	I	.51	.33	.95	.16	1.97
907DG	7/32"	I	.51	.37	.95	.16	1.97
908DG	1/4"	I	.51	.41	.95	.16	1.97
909DG	9/32"	III	.51	.44	.95	.16	1.97
910DG	5/16"	III	.51	.49	.95	.16	1.97
911DG	11/32"	III	.51	.54	.95	.16	1.97
912DG	3/8"	III	.51	.59	.95	.24	1.97
914DG	7/16"	III	.51	.64	.95	.24	1.97
916DG	1/2"	III	.51	.74	.95	.28	1.97



Deep Length - Metric Sizes

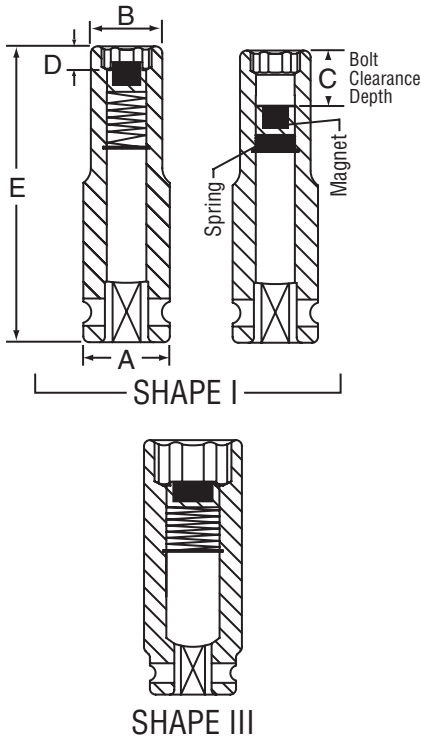

Item Number	Hex Size	Shape	Dimensions (Millimeters)				
			A	B	C	D	E
905MDG	5mm	I	13	8.8	24	4	50
955MDG	5.5mm	I	13	9.5	24	4	50
906MDG	6mm	I	13	10.0	24	4	50
907MDG	7mm	I	13	11.3	24	4	50
908MDG	8mm	I	13	12.5	24	4	50
909MDG	9mm	III	13	13.8	24	4	50
910MDG	10mm	III	13	15.0	24	6	50
911MDG	11mm	III	13	16.3	24	6	50
912MDG	12mm	III	13	17.0	24	6	50
913MDG	13mm	III	13	18.8	24	7	50
914MDG	14mm	III	13	20.0	24	7	50
915MDG	15mm	III	13	21.0	24	8	50



1/4" Drive Impact Sockets



1/4"

1/4" Drive Magnetic - Standard Length Universal - Metric Sizes ▲ MM

Magnetic

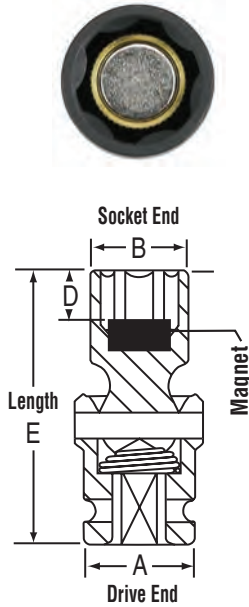

Item Number	Hex Size	Dimensions (Millimeters)			
		A	B	C	E
905UMG	5mm	15	8.8	3	43
955UMG	5.5mm	15	9.5	3	43
906UMG	6mm	15	10.0	3	43
907UMG	7mm	15	11.5	3	43
908UMG	8mm	15	12.5	3	43
909UMG	9mm	15	14.0	4	43
910UMG	10mm	15	15.0	4	43
911UMG	11mm	15	16.5	5	43
912UMG	12mm	16	16.8	5	48
913UMG	13mm	16	18.8	5	48
914UMG	14mm	16	19.8	6	48
915UMG	15mm	16	20.8	6	48

1/4" Drive Adapter SAE

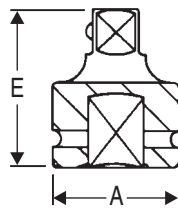

Item Number	Female End	Male End	Socket Retention Device	Dimensions (Inches)	
				A	E
938A	1/4"	3/8"	Friction Ball	.54	1.02

*See page 182 for Reducing Sleeve Adapters

1/4" Drive Universal Joint SAE



Item Number	Size	Socket Retention Device	Dimensions (Inches)		
			A	B	E
929UJ	1/4" x 1/4"	Friction Ball	.63	.71	1.69



1/4" Drive Impact Attachments



No. 9703E 1/4" Drive Impact Extension Set SAE



1/4"

3 piece set contents:



- 943E 3" Extension
 - 946E 6" Extension
 - 950E 10" Extension
- Hanger Tag

All items use the Friction Ball Retainer.

1/4" Drive Extensions SAE



Item Number	Description	Socket Retention Device	Dimensions (Inches)	
			A	E
Standard Extensions				
942E	2" Extension	Friction Ball	.51	1.97
943E	3" Extension	Friction Ball	.51	2.95
944E	4" Extension	Friction Ball	.51	3.94
946E	6" Extension	Friction Ball	.51	5.91
950E	10" Extension	Friction Ball	.51	9.84

Locking Extensions

These extensions feature a positive locking ball and sliding collar for quick release of sockets and accessories. Useful in hard to reach areas where a positive lock on the socket is required.

9703QL 3 pc. Locking Extension Set - includes 3", 6", 12"

943QL	3" Locking Extension	.51	2.95
946QL	6" Locking Extension	.51	5.91
952QL	12" Locking Extension	.51	11.81
958QL	18" Locking Extension	.51	17.72
964QL	24" Locking Extension	.51	24.02

Socket Retention Device Key for 1/4" Drive Adapters, Extensions & Universal Joints



FB Friction Ball

A spring loaded steel ball that lines up with the socket retainer hole. Use caution when using this system because the socket is held in place only by spring pressure on the steel ball.

Do NOT run the tool when the socket is OFF the fastener.



3/8" Drive Fractional Impact Socket Sets



6 No. 1213 3/8" Drive Standard Length Fractional Set SAE



12 piece set contents:

1010R.....	5/16"	1022R.....	11/16"
1012R.....	3/8"	1024R.....	3/4"
1014R.....	7/16"	1026R.....	13/16"
1016R.....	1/2"	1028R.....	7/8"
1018R.....	9/16"	1030R.....	15/16"
1020R.....	5/8"	1032R.....	1"

Molded Storage Case

3/8"

6 No. 1213SD 3/8" Drive Semi-Deep Length Fractional Set SAE



12 piece set contents:

1010SD.....	5/16"	1022SD.....	11/16"
1012SD.....	3/8"	1024SD.....	3/4"
1014SD.....	7/16"	1026SD.....	13/16"
1016SD.....	1/2"	1028SD.....	7/8"
1018SD.....	9/16"	1030SD.....	15/16"
1020SD.....	5/8"	1032SD.....	1"

Molded Storage Case

6 No. 1213D 3/8" Drive Deep Length Fractional Set SAE



12 piece set contents:

1010D.....	5/16"	1022D.....	11/16"
1012D.....	3/8"	1024D.....	3/4"
1014D.....	7/16"	1026D.....	13/16"
1016D.....	1/2"	1028D.....	7/8"
1018D.....	9/16"	1030D.....	15/16"
1020D.....	5/8"	1032D.....	1"

Molded Storage Case



3/8" Drive Metric Impact Socket Sets



6 No. 1213M 3/8" Drive Standard Length Metric Set MM



13 piece set contents:

1007M.....	.7mm	1014M.....	.14mm
1008M.....	.8mm	1015M.....	.15mm
1009M.....	.9mm	1016M.....	.16mm
1010M.....	.10mm	1017M.....	.17mm
1011M.....	.11mm	1018M.....	.18mm
1012M.....	.12mm	1019M.....	.19mm
1013M.....	.13mm		Molded Storage Case

3/8"

6 No. 1213MSD 3/8" Drive Semi-Deep Length Metric Set MM



13 piece set contents:

1007MSD.....	.7mm	1014MSD.....	.14mm
1008MSD.....	.8mm	1015MSD.....	.15mm
1009MSD.....	.9mm	1016MSD.....	.16mm
1010MSD.....	.10mm	1017MSD.....	.17mm
1011MSD.....	.11mm	1018MSD.....	.18mm
1012MSD.....	.12mm	1019MSD.....	.19mm
1013MSD.....	.13mm		Molded Storage Case

6 No. 1213MD 3/8" Drive Deep Length Metric Set MM



13 piece set contents:

1007MD.....	.7mm	1014MD.....	.14mm
1008MD.....	.8mm	1015MD.....	.15mm
1009MD.....	.9mm	1016MD.....	.16mm
1010MD.....	.10mm	1017MD.....	.17mm
1011MD.....	.11mm	1018MD.....	.18mm
1012MD.....	.12mm	1019MD.....	.19mm
1013MD.....	.13mm		Molded Storage Case



3/8" Drive Impact Socket Set



6

No. 1281

3/8" Drive Fractional & Metric Master Socket Set



This set contains our most popular 3/8" drive 6 point sockets and universals with extended range metric sizes up to 22mm. Also included is a 3" extension, universal joint and 1/4" hex to 3/8" square adapter for use with hex drive impact tools. All packed in a compact, low profile, blow molded storage case which can be used as a tool box organizer when the cover is removed.



81 piece set contents:

- 12 Pieces Fractional Standard Length: 5/16", 3/8", 7/16", 1/2", 9/16", 5/8", 11/16", 3/4", 13/16", 7/8", 15/16", 1"
- 12 Pieces Fractional Deep Length: 5/16", 3/8", 7/16", 1/2", 9/16", 5/8", 11/16", 3/4", 13/16", 7/8", 15/16", 1"
- 16 Pieces Metric Standard Length: 7mm, 8mm, 9mm, 10mm, 11mm, 12mm, 13mm, 14mm, 15mm, 16mm, 17mm, 18mm, 19mm, 20mm, 21mm, 22mm
- 16 Pieces Metric Deep Length: 7mm, 8mm, 9mm, 10mm, 11mm, 12mm, 13mm, 14mm, 15mm, 16mm, 17mm, 18mm, 19mm, 20mm, 21mm, 22mm
- 12 Pieces Standard Length Fractional Universal: 5/16", 3/8", 7/16", 1/2", 9/16", 5/8", 11/16", 3/4", 13/16", 7/8", 15/16", 1"
- 10 Pieces Standard Length Metric Universal: 10mm, 11mm, 12mm, 13mm, 14mm, 15mm, 16mm, 17mm, 18mm, 19mm
- 1 Piece Each: 3" Extension, 3/8" Universal Joint, 1/4" Hex x 3/8" Square Adapter
- Molded Storage Case



3/8" Drive Impact Socket Sets



6 No. 1243RD 3/8" Drive Standard & Deep Length Master Set



Set contains both Fractional and Metric sizes standard and deep lengths plus a 3" extension, universal joint and 1/4" hex x 3/8" square adapter. Packaged in an all new compact, low profile molded storage case for easy transport and storage.

43 piece set contents:

8 Pieces Fractional Standard Length:

5/16", 3/8", 7/16", 1/2", 9/16", 5/8", 11/16", 3/4"

8 Pieces Fractional Deep Length:

5/16", 3/8", 7/16", 1/2", 9/16", 5/8", 11/16", 3/4"

12 Pieces Metric Standard Length:

8mm, 9mm, 10mm, 11mm, 12mm, 13mm, 14mm, 15mm, 16mm, 17mm, 18mm, 19mm

12 Pieces Metric Deep Length:

8mm, 9mm, 10mm, 11mm, 12mm, 13mm, 14mm, 15mm, 16mm, 17mm, 18mm, 19mm

1 Piece Each:

- 3" Extension
- 3/8" Universal Joint
- 1/4" Hex x 3/8" Square Adapter

Molded Storage Case



3/8"

6 No. 1229DM* 3/8" Drive Deep Length Set



Set contains deep length Fractional and Metric sizes plus a 3" extension, universal joint and adapter packaged in a molded storage case for easy transport and storage.

*Patent Number DES.395,166



29 piece set contents:

12 Pieces Fractional Deep Length:

5/16", 3/8", 7/16", 1/2", 9/16", 5/8", 11/16", 3/4", 13/16", 7/8", 15/16", 1"

14 Pieces Metric Deep Length:

8mm, 9mm, 10mm, 11mm, 12mm, 13mm, 14mm, 15mm, 16mm, 17mm, 18mm, 19mm, 21mm, 22mm

1 Piece Each:

- 3" Extension
- 1/2" Female x 3/8" Male Adapter
- 3/8" Universal Joint

Molded Storage Case



3/8" Drive Impact Socket Set



6 No. 1226M 3/8" Drive Standard & Deep Length Metric Master Set MM



26 piece set contents:

13 Pieces Metric Standard Length:

7mm, 8mm, 9mm, 10mm, 11mm, 12mm, 13mm, 14mm, 15mm, 16mm, 17mm, 18mm, 19mm

13 Pieces Metric Deep Length:

7mm, 8mm, 9mm, 10mm, 11mm, 12mm, 13mm, 14mm, 15mm, 16mm, 17mm, 18mm, 19mm

Molded Storage Case

No. 1224RD 3/8" Drive Standard and Deep Length Fractional Set SAE



24 piece set contents:

12 Pieces Fractional Standard Length:

5/16", 3/8", 7/16", 1/2", 9/16", 5/8", 11/16", 3/4", 13/16", 7/8", 15/16", 1"

12 Pieces Fractional Deep Length:

5/16", 3/8", 7/16", 1/2", 9/16", 5/8", 11/16", 3/4", 13/16", 7/8", 15/16", 1"

Molded Storage Case



No. 1104E 3/8" Drive Impact Extension Set SAE



4 piece set contents:

- 1140E..... 1-3/4" Extension
- 1143E..... .3" Extension
- 1146E..... .6" Extension
- 1152E..... .12" Extension
- Molded Storage Case

All items use the Friction Ball Retainer.



3/8"

No. 1100 3/8" Drive Impact Adapter & Extension Set SAE



6 piece set contents:

- 1128A*..... 3/8" F. x 1/4" M. Adapter
- 1138A..... 3/8" F. x 1/2" M. Adapter
- 1129UJ..... 3/8" x 3/8" Universal Joint
- 1140E..... 1-3/4" Extension
- 1143E..... .3" Extension
- 1146E..... .6" Extension
- Molded Storage Case

All items use the Friction Ball Retainer.

* Reducing Adapters are not covered by the GP Warranty.





3/8" Drive 12-Point Fractional Impact Socket Sets



12 No. 1202 3/8" Drive 12-Point Standard Length Fractional Set SAE



12 piece set contents:

1110R 5/16"	1122R 11/16"
1112R 3/8"	1124R 3/4"
1114R 7/16"	1126R 13/16"
1116R 1/2"	1128R 7/8"
1118R 9/16"	1130R 15/16"
1120R 5/8"	1132R 1"

Molded Storage Case

12 No. 1202SD 3/8" Drive 12-Point Semi-Deep Length Fractional Set SAE



12 piece set contents:

1110SD 5/16"	1122SD 11/16"
1112SD 3/8"	1124SD 3/4"
1114SD 7/16"	1126SD 13/16"
1116SD 1/2"	1128SD 7/8"
1118SD 9/16"	1130SD 15/16"
1120SD 5/8"	1132SD 1"

Molded Storage Case

12 No. 1202D 3/8" Drive 12-Point Deep Length Fractional Set SAE



12 piece set contents:

1110D 5/16"	1122D 11/16"
1102D 3/8"	1124D 3/4"
1114D 7/16"	1126D 13/16"
1116D 1/2"	1128D 7/8"
1118D 9/16"	1130D 15/16"
1120D 5/8"	1132D 1"

Molded Storage Case



3/8" Drive 12-Point Metric Impact Socket Sets



12 No. 1203M 3/8" Drive 12-Point Standard Length Metric Set MM



13 piece set contents:

1107M	7mm	1114M	14mm
1108M	8mm	1115M	15mm
1109M	9mm	1116M	16mm
1110M	10mm	1117M	17mm
1111M	11mm	1118M	18mm
1112M	12mm	1119M	19mm
1113M	13mm			Molded Storage Case

3/8"

12 No. 1203MSD 3/8" Drive 12-Point Semi-Deep Length Metric Set MM



13 piece set contents:

1107MSD	7mm	1114MSD	14mm
1108MSD	8mm	1115MSD	15mm
1109MSD	9mm	1116MSD	16mm
1110MSD	10mm	1117MSD	17mm
1111MSD	11mm	1118MSD	18mm
1112MSD	12mm	1119MSD	19mm
1113MSD	13mm			Molded Storage Case

12 No. 1203MD 3/8" Drive 12-Point Deep Length Metric Set MM



13 piece set contents:

1107MD	7mm	1114MD	14mm
1108MD	8mm	1115MD	15mm
1109MD	9mm	1116MD	16mm
1110MD	10mm	1117MD	17mm
1111MD	11mm	1118MD	18mm
1112MD	12mm	1119MD	19mm
1113MD	13mm			Molded Storage Case





3/8" Drive 12-Point Metric Impact Socket Sets



12 No. 1643RD 3/8" Drive 12-Point Standard & Deep Length Master Set SAE MM

3/8"



Set contains both Fractional and Metric sizes standard and deep lengths plus a 3" extension, universal joint, and 1/4" hex x 3/8" square adapter. Packaged in an all new compact, low profile molded storage case for easy transport and storage.



43 piece set contents:

8 Pieces Fractional Standard Length:

5/16", 3/8", 7/16", 1/2", 9/16", 5/8", 11/16", 3/4"

8 Pieces Fractional Deep Length:

5/16", 3/8", 7/16", 1/2", 9/16", 5/8", 11/16", 3/4"

12 Pieces Metric Standard Length:

8mm, 9mm, 10mm, 11mm, 12mm, 13mm, 14mm, 15mm, 16mm, 17mm, 18mm, 19mm

12 Pieces Metric Deep Length:

8mm, 9mm, 10mm, 11mm, 12mm, 13mm, 14mm, 15mm, 16mm, 17mm, 18mm, 19mm

1 Piece Each:

- 3" Extension
- 3/8" Universal Joint
- 1/4" Hex x 3/8" Square Adapter

Molded Storage Case



3/8" Drive Fractional Universal Impact Socket Sets



6 No. 1212U 3/8" Drive Standard Length Fractional Universal Set SAE



12 piece set contents:

1010U	5/16"	1022U	11/16"
1012U	3/8"	1024U	3/4"
1014U	7/16"	1026U	13/16"
1016U	1/2"	1028U	7/8"
1018U	9/16"	1030U	15/16"
1020U	5/8"	1032U	1"

Molded Storage Case

3/8"

6 No. 1212USD 3/8" Drive Semi-Deep Length Fractional Universal Set SAE



12 piece set contents:

1010USD	5/16"	1022USD	11/16"
1012USD	3/8"	1024USD	3/4"
1014USD	7/16"	1026USD	13/16"
1016USD	1/2"	1028USD	7/8"
1018USD	9/16"	1030USD	15/16"
1020USD	5/8"	1032USD	1"

Molded Storage Case



6 No. 1212UD 3/8" Drive Deep Length Fractional Universal Set SAE



12 piece set contents:

1010UD	5/16"	1022UD	11/16"
1012UD	3/8"	1024UD	3/4"
1014UD	7/16"	1026UD	13/16"
1016UD	1/2"	1028UD	7/8"
1018UD	9/16"	1030UD	15/16"
1020UD	5/8"	1032UD	1"

Molded Storage Case





3/8" Drive Metric Universal Impact Socket Sets



3/8"

6 No. 1210UM 3/8" Drive Standard Length Metric Universal Set MM



10 piece set contents:

1010UM10mm	1015UM15mm
1011UM11mm	1016UM16mm
1012UM12mm	1017UM17mm
1013UM13mm	1018UM18mm
1014UM14mm	1019UM19mm
Molded Storage Case					

6 No. 1210UMSD 3/8" Drive Semi-Deep Length Metric Universal Set MM



10 piece set contents:

1010UMSD10mm	1015UMSD15mm
1011UMSD11mm	1016UMSD16mm
1012UMSD12mm	1017UMSD17mm
1013UMSD13mm	1018UMSD18mm
1014UMSD14mm	1019UMSD19mm
Molded Storage Case					



6 No. 1210UMD 3/8" Drive Deep Length Metric Universal Set MM



10 piece set contents:

1010UMD10mm	1015UMD15mm
1011UMD11mm	1016UMD16mm
1012UMD12mm	1017UMD17mm
1013UMD13mm	1018UMD18mm
1014UMD14mm	1019UMD19mm
Molded Storage Case					



3/8" Drive 12-Point Universal Impact Socket Sets



12 No. 1612U 3/8" Drive 12-Point Standard Length Fractional Universal Set SAE



12 piece set contents:

1110U	5/16"	1122U	11/16"
1112U	3/8"	1124U	3/4"
1114U	7/16"	1126U	13/16"
1116U	1/2"	1128U	7/8"
1118U	9/16"	1130U	15/16"
1120U	5/8"	1132U	1"

Molded Storage Case



3/8"

12 No. 1610UM 3/8" Drive 12-Point Standard Length Metric Universal Set MM



10 piece set contents:

1110UM	10mm	1115UM	15mm
1111UM	11mm	1116UM	16mm
1112UM	12mm	1117UM	17mm
1113UM	13mm	1118UM	18mm
1114UM	14mm	1119UM	19mm

Molded Storage Case





3/8" Drive Magnetic Impact Socket Sets



No. 1224G 3/8" Drive Standard Length Fractional & Metric Magnetic Set



This set contains standard length, fractional and metric sizes along with an extension and universal joint packaged in a molded storage case. The powerful magnets hold any fastener securely. Great for use in impact or non-impact applications.

24 piece set contents:

1008RG 1/4"	1007MG 7mm
1010RG 5/16"	1008MG 8mm
1012RG 3/8"	1009MG 9mm
1014RG 7/16"	1010MG 10mm
1016RG 1/2"	1011MG 11mm
1018RG 9/16"	1012MG 12mm
1020RG 5/8"	1013MG 13mm
1022RG 11/16"	1014MG 14mm
1024RG 3/4"	1015MG 15mm
	1016MG 16mm
	1017MG 17mm
	1018MG 18mm
	1019MG 19mm
	1143E 3" Extension
	1129UJ 3/8" x 3/8" Universal Joint



No. 1209G 3/8" Drive Standard Length Fractional Magnetic Set



9 piece set contents:

1008RG 1/4"	1016RG 1/2"
1010RG 5/16"	1018RG 9/16"
1012RG 3/8"	1020RG 5/8"
1014RG 7/16"	1022RG 11/16"
	1024RG 3/4"

On a Metal Clip Rail



No. 1213MG 3/8" Drive Standard Length Metric Magnetic Set



13 piece set contents:

1007MG 7mm	1013MG 13mm
1008MG 8mm	1014MG 14mm
1009MG 9mm	1015MG 15mm
1010MG 10mm	1016MG 16mm
1011MG 11mm	1017MG 17mm
1012MG 12mm	1018MG 18mm
	1019MG 19mm

On a Metal Clip Rail





3/8" Drive Magnetic Impact Socket Sets



No. 1209DG 3/8" Drive Deep Length Fractional Magnetic Set SAE

These Magnetic sockets feature a spring loaded magnet that retracts into the socket for extended bolt applications.

3/8"



9 piece set contents:

1008DG 1/4"	1016DG 1/2"
1010DG 5/16"	1018DG 9/16"
1012DG 3/8"	1020DG 5/8"
1014DG 7/16"	1022DG 11/16"
On a Metal Clip Rail	1024DG 3/4"



No. 1213MDG 3/8" Drive Deep Length Metric Magnetic Set MM

These Magnetic sockets feature a spring loaded magnet that retracts into the socket for extended bolt applications.



13 piece set contents:

1007MDG 7mm	1013MDG 13mm
1008MDG 8mm	1014MDG 14mm
1009MDG 9mm	1015MDG 15mm
1010MDG 10mm	1016MDG 16mm
1011MDG 11mm	1017MDG 17mm
1012MDG 12mm	1018MDG 18mm
On a Metal Clip Rail	1019MDG 19mm



WARNING: Always wear safety goggles when using Impact Tools. Use only properly matched fractional or metric sizes.





3/8" Drive Pipe Plug Impact Sockets



4 No. 1211P 3/8" Drive Pipe Plug Socket Set SAE



11 piece set contents:

Male Sizes

1006PP	3/16"
1008PP	1/4"
1009PP	9/32"
1010PP	5/16"
1011PP	11/32"
1012PP	3/8"

Female Sizes

1008FP	1/4"
1009FP	9/32"
1010FP	5/16"
1011FP	11/32"
1012FP	3/8"

Molded Storage Case



4 3/8" Drive Individual Pipe Plug Sockets SAE

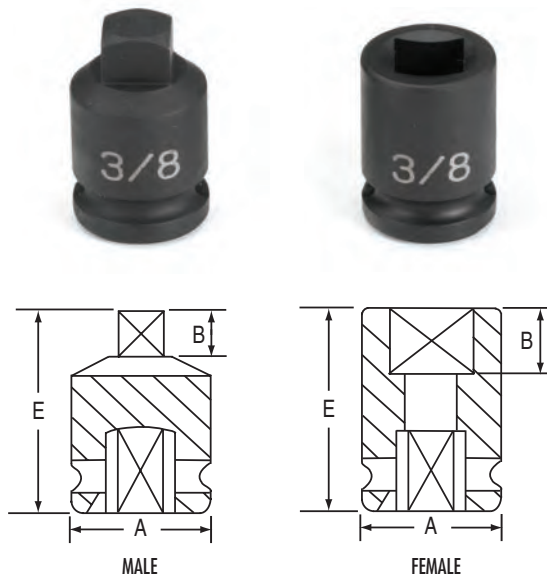

Item Number	Size	Dimensions (Inches)		
		A	B	E
Male Sizes				
1006PP	3/16"	.75	.28	1.18
1008PP	1/4"	.75	.28	1.18
1009PP	9/32"	.75	.28	1.18
1010PP	5/16"	.75	.28	1.18
1011PP	11/32"	.75	.28	1.18
1012PP	3/8"	.75	.28	1.18

Female Sizes				
1008FP	1/4"	.75	.28	.98
1009FP	9/32"	.75	.28	.98
1010FP	5/16"	.75	.28	.98
1011FP	11/32"	.75	.28	.98
1012FP	3/8"	.75	.28	.98



3/8" Drive Standard Length Impact Sockets



6 3/8" Drive - Standard Length - Fractional Sizes SAE



Item Number	Hex Size	Shape	Dimensions (Inches)				
			A	B	C	D	E
1010R	5/16"	I	.75	.49	.69	.31	1.18
1012R	3/8"	I	.75	.57	.69	.31	1.18
1014R	7/16"	I	.75	.67	.69	.35	1.18
1016R	1/2"	II	.75	.75	.69	.35	1.18
1018R	9/16"	II	.79	.79	.69	.43	1.18
1020R	5/8"	II	.93	.93	.69	.47	1.18
1022R	11/16"	II	.94	.94	.69	.47	1.18
1024R	3/4"	II	1.02	1.02	.69	.51	1.18
1026R	13/16"	II	1.10	1.10	.69	.51	1.18
1028R	7/8"	II	1.18	1.18	.69	.51	1.18
1030R	15/16"	II	1.26	1.26	.69	.51	1.18
1032R	1"	II	1.34	1.34	.69	.51	1.18

ANSI Specifications B107.2

3/8"

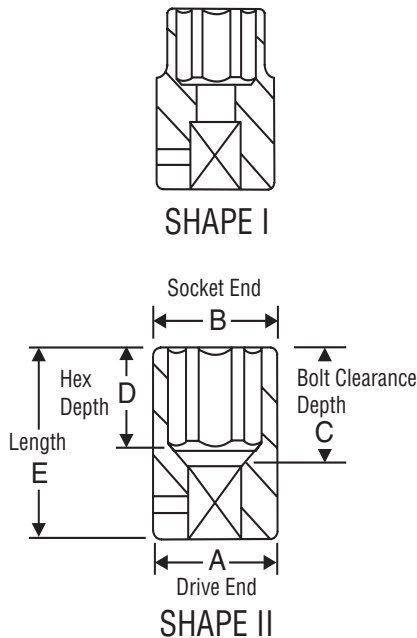

6 Standard Length - Metric Sizes MM

Item Number	Hex Size	Shape	Dimensions (Millimeters)				
			A	B	C	D	E
1007M	7mm	I	19	11.5	17.5	8	30
1008M	8mm	I	19	12.5	17.5	8	30
1009M	9mm	I	19	14.0	17.5	8	30
1010M	10mm	I	19	15.0	17.5	8	30
1011M	11mm	I	19	17.0	17.5	9	30
1012M	12mm	II	19	19.0	17.5	9	30
1013M	13mm	II	19	19.0	17.5	10	30
1014M	14mm	II	20	20.0	17.5	11	30
1015M	15mm	II	22	22.0	17.5	11	30
1016M	16mm	II	24	24.0	17.5	12	30
1017M	17mm	II	24	24.0	17.5	12	30
1018M	18mm	II	25	25.0	17.5	12	30
1019M	19mm	II	26	26.0	17.5	13	30
1020M	20mm	II	28	28.0	17.5	13	30
1021M	21mm	II	28	28.0	17.5	13	30
1022M	22mm	II	30	30.0	17.5	13	30



3/8" Drive Semi-Deep Length Impact Sockets



6 3/8" Drive - Semi-Deep Length - Fractional Sizes SAE



Item Number	Hex Size	Shape	Dimensions (Inches)				
			A	B	C	D	E
1010SD	5/16"	I	.69	.50	1.14	.25	1.63
1012SD	3/8"	I	.69	.56	1.14	.28	1.63
1014SD	7/16"	I	.75	.66	1.14	.34	1.63
1016SD	1/2"	II	.75	.75	1.14	.41	1.63
1018SD	9/16"	II	.81	.81	1.14	.41	1.63
1020SD	5/8"	II	.91	.91	1.14	.41	1.63
1022SD	11/16"	II	.97	.97	1.14	.44	1.63
1024SD	3/4"	II	1.05	1.05	1.14	.46	1.63
1026SD	13/16"	II	1.13	1.13	1.14	.50	1.63
1028SD	7/8"	II	1.19	1.19	1.14	.53	1.63
1030SD	15/16"	II	1.28	1.28	1.14	.53	1.63
1032SD	1"	II	1.34	1.34	1.14	.56	1.63

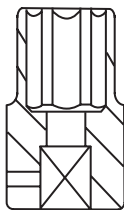

SHAPE I

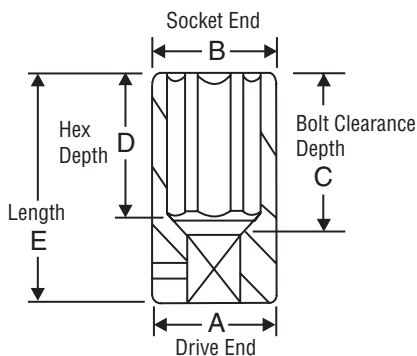

SHAPE II

6 Semi-Deep Length - Metric Sizes MM

Item Number	Hex Size	Shape	Dimensions (Millimeters)				
			A	B	C	D	E
1007MSD	7mm	I	17.2	11.6	29	5.6	41
1008MSD	8mm	I	17.2	12.8	29	6.4	41
1009MSD	9mm	I	17.2	14.0	29	7.1	41
1010MSD	10mm	I	17.2	15.1	29	9.7	41
1011MSD	11mm	I	17.2	16.4	29	9.7	41
1012MSD	12mm	II	18.0	18.0	29	9.7	41
1013MSD	13mm	II	19.6	19.6	29	10.4	41
1014MSD	14mm	II	20.4	20.4	29	10.4	41
1015MSD	15mm	II	21.2	21.2	29	10.4	41
1016MSD	16mm	II	22.7	22.7	29	10.4	41
1017MSD	17mm	II	24.3	24.3	29	11.2	41
1018MSD	18mm	II	25.1	25.1	29	11.2	41
1019MSD	19mm	II	26.7	26.7	29	11.7	41



3/8" Drive Deep Length Impact Sockets



6 3/8" Drive - Deep Length - Fractional Sizes SAE



Item Number	Hex Size	Shape	Dimensions (Inches)				
			A	B	C	D	E
1010D	5/16"	I	.75	.49	1.93	.47	2.48
1012D	3/8"	I	.75	.57	2.01	.47	2.56
1014D	7/16"	I	.75	.67	2.01	.87	2.56
1016D	1/2"	II	.75	.75	2.09	.87	2.56
1018D	9/16"	II	.79	.79	2.09	.87	2.56
1020D	5/8"	II	.93	.93	2.09	.94	2.56
1022D	11/16"	II	.94	.94	2.09	.94	2.56
1024D	3/4"	II	1.02	1.02	2.09	.94	2.56
1026D	13/16"	II	1.10	1.10	2.09	.94	2.56
1028D	7/8"	II	1.18	1.18	2.09	.94	2.56
1030D	15/16"	II	1.26	1.26	2.09	.94	2.56
1032D	1"	II	1.34	1.34	2.09	.94	2.56

ANSI Specifications B107.2

3/8"

6 Deep Length - Metric Sizes MM

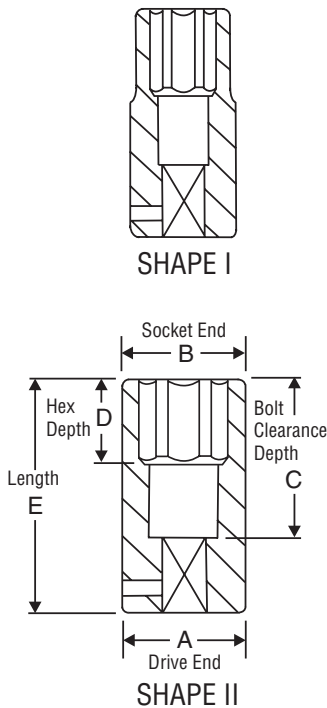

Item Number	Hex Size	Shape	Dimensions (Millimeters)				
			A	B	C	D	E
1007MD	7mm	I	19	11.5	49	12	63
1008MD	8mm	I	19	12.5	49	12	63
1009MD	9mm	I	19	14.0	51	12	65
1010MD	10mm	I	19	15.0	51	22	65
1011MD	11mm	I	19	17.0	51	22	65
1012MD	12mm	II	19	19.0	53	22	65
1013MD	13mm	II	19	19.0	53	22	65
1014MD	14mm	II	20	20.0	53	22	65
1015MD	15mm	II	22	22.0	53	22	65
1016MD	16mm	II	24	24.0	53	24	65
1017MD	17mm	II	24	24.0	53	24	65
1018MD	18mm	II	26	25.0	53	24	65
1019MD	19mm	II	26	26.0	53	24	65
1020MD	20mm	II	28	28.0	53	24	65
1021MD	21mm	II	28	28.0	53	24	65
1022MD	22mm	II	30	30.0	53	24	65



3/8" Drive 12-Point Standard Length Impact Sockets



12 3/8" Drive 12-Point - Standard Length - Fractional Sizes SAE



Item Number	12-Point Size	Shape	Dimensions (Inches)				
			A	B	C	D	E
1110R	5/16"	I	.75	.49	.71	.24	1.18
1112R	3/8"	I	.75	.57	.71	.24	1.18
1114R	7/16"	I	.75	.67	.71	.31	1.18
1116R	1/2"	II	.75	.75	.71	.35	1.18
1118R	9/16"	II	.79	.79	.71	.43	1.18
1120R	5/8"	II	.93	.93	.71	.43	1.18
1122R	11/16"	II	.94	.94	.71	.43	1.18
1124R	3/4"	II	1.02	1.02	.71	.51	1.18
1126R	13/16"	II	1.10	1.10	.71	.59	1.18
1128R	7/8"	II	1.18	1.18	.71	.59	1.18
1130R	15/16"	II	1.26	1.26	.71	.63	1.18
1132R	1"	II	1.34	1.34	.71	.63	1.18

ANSI Specifications B107.2

12 Standard Length - Metric Sizes MM

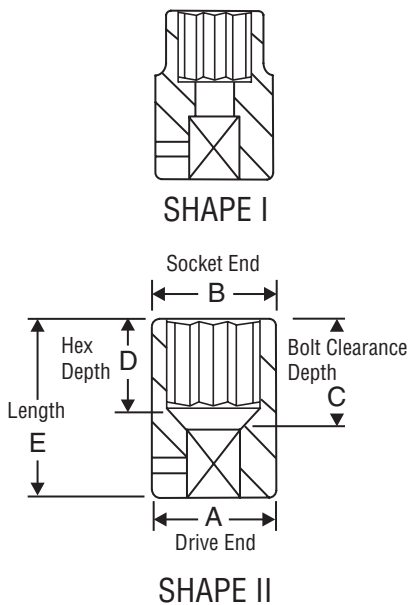

Item Number	12-Point Size	Shape	Dimensions (Millimeters)				
			A	B	C	D	E
1107M	7mm	I	19	11.5	18	5	30
1108M	8mm	I	19	12.5	18	6	30
1109M	9mm	I	19	14.0	18	6	30
1110M	10mm	I	19	15.0	18	7	30
1111M	11mm	I	19	17.0	18	8	30
1112M	12mm	II	19	19.0	18	9	30
1113M	13mm	II	19	19.0	18	9	30
1114M	14mm	II	20	20.0	18	11	30
1115M	15mm	II	22	22.0	18	11	30
1116M	16mm	II	24	24.0	18	11	30
1117M	17mm	II	24	24.0	18	11	30
1118M	18mm	II	25	25.0	18	13	30
1119M	19mm	II	26	26.0	18	13	30
1120M	20mm	II	28	28.0	18	13	30
1121M	21mm	II	28	28.0	18	15	30
1122M	22mm	II	30	30.0	18	15	30



3/8" Drive 12-Point Semi-Deep Length Impact Sockets



12 3/8" Drive 12-Point - Semi-Deep Length - Fractional Sizes SAE



Item Number	12-Point Size	Shape	Dimensions (Inches)				
			A	B	C	D	E
1110SD	5/16"	I	.69	.50	1.14	.25	1.63
1112SD	3/8"	I	.69	.56	1.14	.28	1.63
1114SD	7/16"	I	.75	.66	1.14	.34	1.63
1116SD	1/2"	II	.75	.75	1.14	.41	1.63
1118SD	9/16"	II	.81	.81	1.14	.41	1.63
1120SD	5/8"	II	.91	.91	1.14	.41	1.63
1122SD	11/16"	II	.97	.97	1.14	.44	1.63
1124SD	3/4"	II	1.05	1.05	1.14	.46	1.63
1126SD	13/16"	II	1.13	1.13	1.14	.50	1.63
1128SD	7/8"	II	1.19	1.19	1.14	.53	1.63
1130SD	15/16"	II	1.28	1.28	1.14	.53	1.63
1132SD	1"	II	1.34	1.34	1.14	.56	1.63

3/8"

12 Semi-Deep Length - Metric Sizes MM

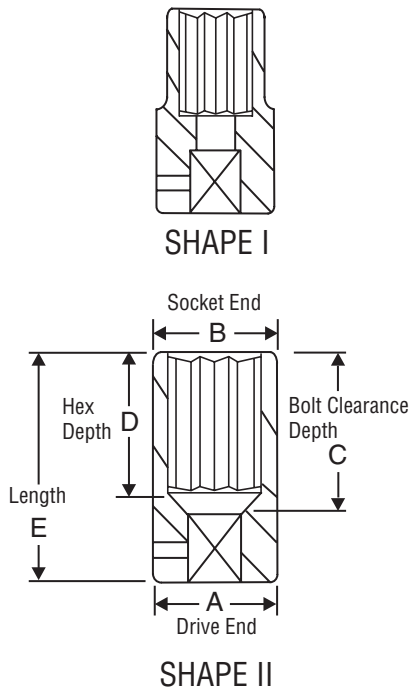

Item Number	12-Point Size	Shape	Dimensions (Millimeters)				
			A	B	C	D	E
1107MSD	7mm	I	17.2	11.6	29	5.6	41
1108MSD	8mm	I	17.2	12.8	29	6.4	41
1109MSD	9mm	I	17.2	14.0	29	7.1	41
1110MSD	10mm	I	17.2	15.1	29	9.7	41
1111MSD	11mm	I	17.2	16.4	29	9.7	41
1112MSD	12mm	II	18.0	18.0	29	9.7	41
1113MSD	13mm	II	19.6	19.6	29	10.4	41
1114MSD	14mm	II	20.4	20.4	29	10.4	41
1115MSD	15mm	II	21.2	21.2	29	10.4	41
1116MSD	16mm	II	22.7	22.7	29	10.4	41
1117MSD	17mm	II	24.3	24.3	29	11.2	41
1118MSD	18mm	II	25.1	25.1	29	11.2	41
1119MSD	19mm	II	26.7	26.7	29	11.7	41



3/8" Drive 12-Point Deep Length Impact Sockets



12 3/8" Drive 12-Point - Deep Length - Fractional Sizes SAE

3/8"



Item Number	12-Point Size	Shape	Dimensions (Inches)				
			A	B	C	D	E
1110D	5/16"	I	.75	.49	2.01	.24	2.48
1102D	3/8"	I	.75	.57	2.09	.24	2.56
1114D	7/16"	I	.75	.67	2.09	.31	2.56
1116D	1/2"	II	.75	.75	2.09	.35	2.56
1118D	9/16"	II	.79	.79	2.09	.43	2.56
1120D	5/8"	II	.93	.93	2.09	.43	2.56
1122D	11/16"	II	.94	.94	2.09	.43	2.56
1124D	3/4"	II	1.02	1.02	2.09	.43	2.56
1126D	13/16"	II	1.10	1.10	2.09	.59	2.56
1128D	7/8"	II	1.18	1.18	2.09	.59	2.56
1130D	15/16"	II	1.26	1.26	2.09	.63	2.56
1132D	1"	II	1.34	1.34	2.09	.63	2.56

ANSI Specifications B107.2

12 Deep Length - Metric Sizes MM

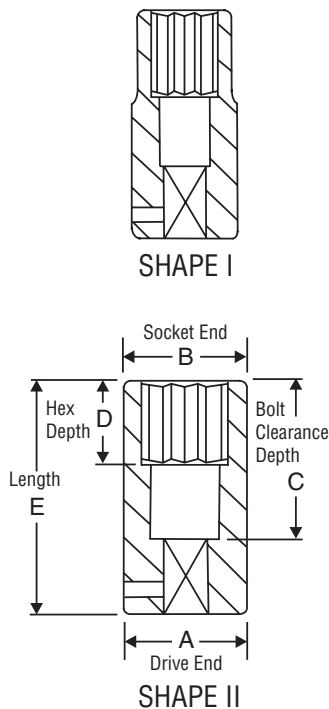

Item Number	12-Point Size	Shape	Dimensions (Millimeters)				
			A	B	C	D	E
1107MD	7mm	I	19	11.5	51	5	63
1108MD	8mm	I	19	12.5	51	6	63
1109MD	9mm	I	19	14.0	53	6	65
1110MD	10mm	I	19	15.0	53	7	65
1111MD	11mm	I	19	17.0	53	8	65
1112MD	12mm	II	19	19.0	53	9	65
1113MD	13mm	II	19	19.0	53	9	65
1114MD	14mm	II	20	20.0	53	11	65
1115MD	15mm	II	22	22.0	53	11	65
1116MD	16mm	II	24	24.0	53	11	65
1117MD	17mm	II	24	24.0	53	11	65
1118MD	18mm	II	25	25.0	53	13	65
1119MD	19mm	II	26	26.0	53	13	65
1120MD	20mm	II	28	28.0	53	13	65
1121MD	21mm	II	28	28.0	53	15	65
1122MD	22mm	II	30	30.0	53	15	65



3/8" Drive Standard Length Universal Impact Sockets



6 3/8" Drive - Standard Length Universal - Fractional Sizes SAE



Item Number	Hex Size	Dimensions (Inches)				
		A	B	C	D	E
1010U	5/16"	.94	.55	.51	.35	2.09
1012U	3/8"	.94	.59	.51	.35	2.09
1014U	7/16"	.94	.67	.51	.35	2.09
1016U	1/2"	.94	.75	.51	.43	2.09
1018U	9/16"	.94	.83	.51	.43	2.09
1020U	5/8"	.94	.91	.51	.43	2.09
1022U	11/16"	.94	.98	.51	.43	2.09
1024U	3/4"	.94	1.06	.51	.43	2.09
1026U	13/16"	.94	1.18	.51	.43	2.09
1028U	7/8"	.94	1.26	.51	.43	2.09
1030U	15/16"	.94	1.34	.51	.43	2.09
1032U	1"	.94	1.42	.51	.43	2.09

ANSI Specifications B107.2

3/8"

6 Standard Length - Metric Sizes MM

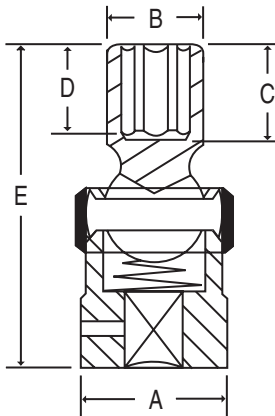

Item Number	Hex Size	Dimensions (Millimeters)				
		A	B	C	D	E
1008UM	8mm	24	14	13	9	53
1009UM	9mm	24	15	13	9	53
1010UM	10mm	24	15	13	9	53
1011UM	11mm	24	17	13	9	53
1012UM	12mm	24	19	13	11	53
1013UM	13mm	24	19	13	11	53
1014UM	14mm	24	21	13	11	53
1015UM	15mm	24	22	13	11	53
1016UM	16mm	24	23	13	11	53
1017UM	17mm	24	25	13	11	53
1018UM	18mm	24	25	13	11	53
1019UM	19mm	24	27	13	11	53
1020UM	20mm	24	30	13	11	53
1021UM	21mm	24	30	13	11	53
1022UM	22mm	24	32	13	11	53



3/8" Drive Semi-Deep Length Universal Impact Sockets



6 3/8" Drive - Semi-Deep Length Universal - Fractional Sizes SAE



Item Number	Hex Size	Dimensions (Inches)				
		A	B	C	D	E
1010USD	5/16"	.94	.50	1.02	.35	2.60
1012USD	3/8"	.94	.56	1.02	.35	2.60
1014USD	7/16"	.94	.66	1.02	.43	2.60
1016USD	1/2"	.94	.75	1.02	.43	2.60
1018USD	9/16"	.94	.81	1.02	.43	2.60
1020USD	5/8"	.94	.91	1.02	.43	2.60
1022USD	11/16"	.94	.97	1.02	.43	2.60
1024USD	3/4"	.94	1.05	1.02	.47	2.60
1026USD	13/16"	.94	1.13	1.02	.47	2.60
1028USD	7/8"	.94	1.19	1.02	.47	2.60
1030USD	15/16"	.94	1.28	1.02	.47	2.60
1032USD	1"	.94	1.34	1.02	.47	2.60

ANSI Specifications B107.2

6 Semi-Deep Length Universal - Metric Sizes MM

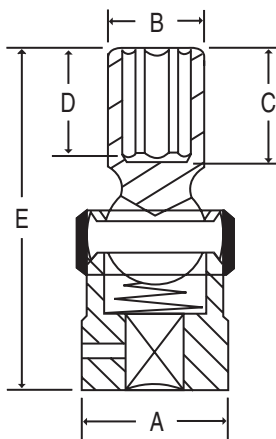

Item Number	Hex Size	Dimensions (Millimeters)				
		A	B	C	D	E
1010UMSD	10mm	24	15.1	26	9	66
1011UMSD	11mm	24	16.4	26	9	66
1012UMSD	12mm	24	18.0	26	11	66
1013UMSD	13mm	24	19.0	26	11	66
1014UMSD	14mm	24	20.4	26	11	66
1015UMSD	15mm	24	21.2	26	11	66
1016UMSD	16mm	24	22.7	26	11	66
1017UMSD	17mm	24	24.3	26	11	66
1018UMSD	18mm	24	25.1	26	11	66
1019UMSD	19mm	24	26.7	26	12	66



3/8" Drive Deep Length Universal Impact Sockets



6 3/8" Drive - Deep Length Universal - Fractional Sizes SAE



Item Number	Hex Size	Dimensions (Inches)				
		A	B	C	D	E
1010UD	5/16"	.94	.55	1.18	.47	2.91
1012UD	3/8"	.94	.59	1.34	.79	3.11
1014UD	7/16"	.94	.67	1.42	.79	3.15
1016UD	1/2"	.94	.75	1.42	.79	3.15
1018UD	9/16"	.94	.83	1.42	.79	3.15
1020UD	5/8"	.94	.91	1.42	.79	3.15
1022UD	11/16"	.94	.98	1.42	.79	3.15
1024UD	3/4"	.94	1.06	1.42	.98	3.15
1026UD	13/16"	.94	1.18	1.42	.98	3.15
1028UD	7/8"	.94	1.26	1.42	1.02	3.15
1030UD	15/16"	.94	1.34	1.42	1.17	3.15
1032UD	1"	.94	1.42	1.42	1.17	3.15

ANSI Specifications B107.2

3/8"

6 Deep Length - Metric Sizes MM

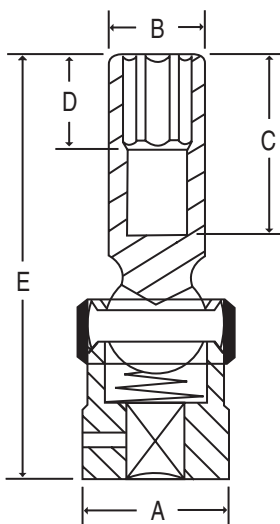

Item Number	Hex Size	Dimensions (Millimeters)				
		A	B	C	D	E
1008UMD	8mm	24	14	34	20	78
1009UMD	9mm	24	15	34	20	78
1010UMD	10mm	24	15	34	20	78
1011UMD	11mm	24	15	36	20	80
1012UMD	12mm	24	17	36	20	80
1013UMD	13mm	24	19	36	20	80
1014UMD	14mm	24	19	36	20	80
1015UMD	15mm	24	21	36	20	80
1016UMD	16mm	24	22	36	20	80
1017UMD	17mm	24	23	36	20	80
1018UMD	18mm	24	25	36	20	80
1019UMD	19mm	24	27	36	25	80
1020UMD	20mm	24	30	36	25	80
1021UMD	21mm	24	30	36	25	80
1022UMD	22mm	24	32	36	25	80



3/8" Drive 12-Point Standard Length Universal Impact Sockets



12 3/8" Drive 12-Point - Standard Length Universal - Fractional Sizes SAE



Item Number	12-Point Size	Dimensions (Inches)				
		A	B	C	D	E
1110U	5/16"	.94	.55	.51	.35	2.09
1112U	3/8"	.94	.59	.51	.35	2.09
1114U	7/16"	.94	.67	.51	.35	2.09
1116U	1/2"	.94	.75	.51	.43	2.09
1118U	9/16"	.94	.83	.51	.43	2.09
1120U	5/8"	.94	.91	.51	.43	2.09
1122U	11/16"	.94	.98	.51	.43	2.09
1124U	3/4"	.94	1.06	.51	.43	2.09
1126U	13/16"	.94	1.18	.51	.43	2.09
1128U	7/8"	.94	1.26	.51	.43	2.09
1130U	15/16"	.94	1.34	.51	.43	2.09
1132U	1"	.94	1.42	.51	.43	2.09

ANSI Specifications B107.2

12 Standard Length - Metric Sizes MM

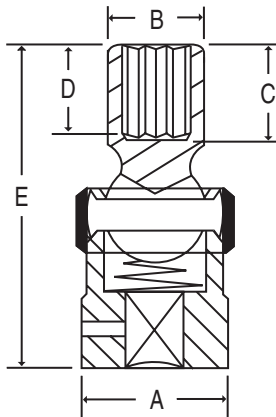

Item Number	12-Point Size	Dimensions (Millimeters)				
		A	B	C	D	E
1108UM	8mm	24	14	13	9	53
1109UM	9mm	24	15	13	9	53
1110UM	10mm	24	15	13	9	53
1111UM	11mm	24	17	13	9	53
*1112UM	12mm	24	19	13	11	53
1113UM	13mm	24	19	13	11	53
1114UM	14mm	24	21	13	11	53
1115UM	15mm	24	22	13	11	53
1116UM	16mm	24	23	13	11	53
1117UM	17mm	24	25	13	11	53
1118UM	18mm	24	25	13	11	53
1119UM	19mm	24	27	13	11	53
1120UM	20mm	24	30	13	11	53
1121UM	21mm	24	30	13	11	53
1122UM	22mm	24	32	13	11	53

* Socket is Designed for Ford Driveshaft Bolts



3/8" Drive Standard Length Magnetic Impact Sockets



3/8" Drive Magnetic - Standard Length - Fractional Sizes SAE



Item Number	Hex Size	Shape	Dimensions (Inches)			
			A	B	D	E
1008RG	1/4"	I	.75	.47	.12	1.18
1010RG	5/16"	I	.75	.55	.12	1.18
1012RG	3/8"	I	.75	.62	.16	1.18
1014RG	7/16"	I	.75	.71	.20	1.18
1016RG	1/2"	III	.75	.79	.20	1.18
1018RG	9/16"	I	.87	.85	.24	1.18
1020RG	5/8"	III	.87	.94	.24	1.18
1022RG	11/16"	III	.87	1.00	.24	1.18
1024RG	3/4"	III	.87	1.08	.28	1.18

3/8"

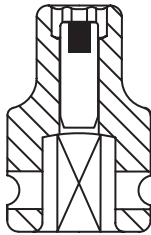

SHAPE I

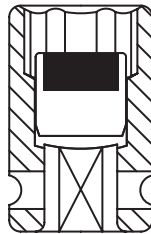

SHAPE II

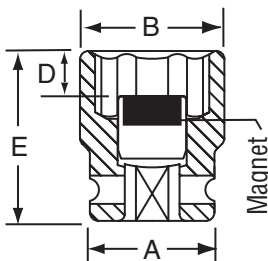

SHAPE III

Standard Length - Metric Sizes MM

Item Number	Hex Size	Shape	Dimensions (Millimeters)			
			A	B	D	E
1007MG	7mm	I	19	12.5	3	30
1008MG	8mm	I	19	14.0	3	30
1009MG	9mm	I	19	15.0	4	30
1010MG	10mm	I	19	16.5	4	30
1011MG	11mm	I	19	17.5	5	30
1012MG	12mm	II	19	19.0	5	30
1013MG	13mm	I	22	20.0	5	30
1014MG	14mm	I	22	21.5	6	30
1015MG	15mm	II	22	22.0	6	30
1016MG	16mm	III	22	24.0	6	30
1017MG	17mm	III	22	25.0	6	30
1018MG	18mm	III	22	26.0	7	30
1019MG	19mm	III	22	27.5	7	30



3/8" Drive Deep Length Magnetic Impact Sockets



All deep Magnetic sockets feature a spring loaded magnet that retracts into the socket for extended bolt applications.

3/8" Drive Magnetic - Deep Length - Fractional Sizes SAE



Item Number	Hex Size	Shape	Dimensions (Inches)				
			A	B	C	D	E
1008DG	1/4"	I	.75	.47	1.69	.16	2.17
1010DG	5/16"	I	.75	.55	1.69	.16	2.17
1012DG	3/8"	I	.75	.62	1.69	.20	2.17
1014DG	7/16"	I	.75	.71	1.69	.24	2.17
1016DG	1/2"	III	.75	.79	1.69	.24	2.17
1018DG	9/16"	I	.87	.85	1.69	.28	2.17
1020DG	5/8"	III	.87	.94	1.69	.28	2.17
1022DG	11/16"	III	.87	1.01	1.69	.28	2.17
1024DG	3/4"	III	.87	1.08	1.69	.31	2.17

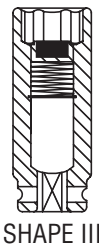
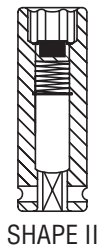
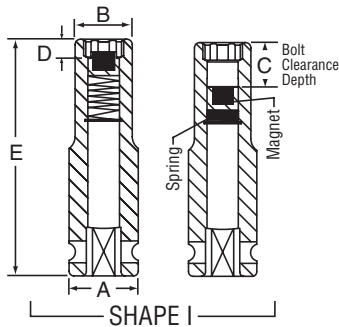

Deep Length - Metric Sizes MM

Item Number	Hex Size	Shape	Dimensions (Millimeters)				
			A	B	C	D	E
1007MDG	7mm	I	19	12.5	43	4	55
1008MDG	8mm	I	19	14.0	43	4	55
1009MDG	9mm	I	19	15.0	43	4	55
1010MDG	10mm	I	19	16.5	43	5	55
1011MDG	11mm	I	19	17.5	43	6	55
1012MDG	12mm	II	19	19.0	43	6	55
1013MDG	13mm	I	22	20.0	43	6	55
1014MDG	14mm	I	22	21.5	43	6	55
1015MDG	15mm	II	22	22.0	43	7	55
1016MDG	16mm	III	22	24.0	43	7	55
1017MDG	17mm	III	22	25.0	43	7	55
1018MDG	18mm	III	22	26.0	43	8	55
1019MDG	19mm	III	22	27.5	43	8	55



3/8" Drive Impact Attachments



3/8" Drive Adapters SAE

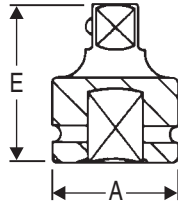

Item Number	Female End	Male End	Socket Retention Device	Dimensions (Inches)	
				A	E
*1128A	3/8"	1/4"	Friction Ball	.87	1.26
*1128AL	3/8"	1/4"	Locking Pin	.87	1.26
1138A	3/8"	1/2"	Friction Ball	.87	1.42
1138AL	3/8"	1/2"	Locking Pin	.87	1.42

* Reducing Adapters are not covered by the GP Warranty.

* See page 182 for Reducing Sleeve Adapters

3/8" Drive Universal Joints SAE



1129UJ
(Standard)



1129TUI
(Thin-Wall)



Item Number	Size	Socket Retention Device	Dimensions (Inches)		
			A	B	E
1129UJ	3/8" x 3/8"	Friction Ball	.94	1.02	1.97
1129UJL	3/8" x 3/8"	Locking Pin	.94	1.02	1.97
*1129TUI	3/8" x 3/8"	Friction Ball	.69	.77	1.85

* 1129TUI is a thin-wall design that provides extra clearance in tight spaces.

Due to the thin wall design the 1129TUI is not covered by the GP Warranty.

3/8" Drive Extensions SAE



Standard



Locking

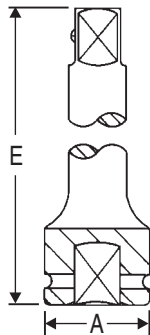

Item Number	Description	Socket Retention Device	Dimensions (Inches)	
			A	E
Standard Extensions				
1140E	1-3/4" Extension	Friction Ball	.75	1.73
1143E	3" Extension	Friction Ball	.75	2.95
1143EL	3" Extension	Locking Pin	.75	2.95
1146E	6" Extension	Friction Ball	.75	5.91
1146EL	6" Extension	Locking Pin	.75	5.91
1152E	12" Extension	Friction Ball	.75	11.80
1152EL	12" Extension	Locking Pin	.75	11.80

Locking Extensions

These extensions feature a positive locking ball and sliding collar for quick release of sockets and accessories. Useful in hard to reach areas where a positive lock on the socket is required.

1103QL 3 pc. Locking Extension Set - includes 3", 6", 12"

1143QL	3" Locking Extension	.75	2.95
1146QL	6" Locking Extension	.75	5.91
1152QL	12" Locking Extension	.75	11.81
1158QL	18" Locking Extension	.75	18.11
1164QL	24" Locking Extension	.75	24.02

Socket Retention Device Key for 3/8" Drive Adapters, Extensions & Universal Joints



Do NOT run the tool when the socket is **OFF** the fastener.



FB Friction Ball

A spring loaded steel ball that lines up with the socket retainer hole. Use caution when using this system because the socket is held in place only by spring pressure on the steel ball.

LP Locking Pin

Spring loaded pin, simply line up with socket retainer hole and press pin. To release socket, insert object through retainer hole and press pin.



1/2" Drive Impact Socket Sets



6 No. 1312 1/2" Drive Standard Length Fractional Set SAE



13 piece set contents:

2014R.....	7/16"	2028R.....	7/8"
2016R.....	1/2"	2030R.....	15/16"
2018R.....	9/16"	2032R.....	1"
2020R.....	5/8"	2034R.....	1-1/16"
2022R.....	11/16"	2036R.....	1-1/8"
2024R.....	3/4"	2040R.....	1-1/4"
2026R.....	13/16"		Molded Storage Case

1/2"

6 No. 1312D 1/2" Drive Deep Length Fractional Set SAE



13 piece set contents:

2014D.....	7/16"	2028D.....	7/8"
2016D.....	1/2"	2030D.....	15/16"
2018D.....	9/16"	2032D.....	1"
2020D.....	5/8"	2034D.....	1-1/16"
2022D.....	11/16"	2036D.....	1-1/8"
2024D.....	3/4"	2040D.....	1-1/4"
2026D.....	13/16"		Molded Storage Case

6 No. 1412M 1/2" Drive Standard Length Metric Set MM



14 piece set contents:

2010M.....	10mm	2018M.....	18mm
2011M.....	11mm	2019M.....	19mm
2012M.....	12mm	2021M.....	21mm
2013M.....	13mm	2022M.....	22mm
2014M.....	14mm	2026M.....	26mm
2015M.....	15mm	2027M.....	27mm
2016M.....	16mm		Molded Storage Case
2017M.....	17mm		

6 No. 1412MD 1/2" Drive Deep Length Metric Set MM



14 piece set contents:

2010MD.....	10mm	2018MD.....	18mm
2011MD.....	11mm	2019MD.....	19mm
2012MD.....	12mm	2021MD.....	21mm
2013MD.....	13mm	2022MD.....	22mm
2014MD.....	14mm	2026MD.....	26mm
2015MD.....	15mm	2027MD.....	27mm
2016MD.....	16mm		Molded Storage Case
2017MD.....	17mm		



1/2" Drive Fractional Impact Socket Master Sets



6 No. 1319 1/2" Drive Standard Length Fractional Master Set SAE



This set includes standard length Fractional sizes from 3/8" through 1-1/2". The set is packaged in a convenient molded case with handle for easy transportation. The cover of the case may be removed to allow the bottom to be used as a tool box organizer.

1/2"

19 piece set contents:



2012R	3/8"	2032R	1"
2014R	7/16"	2034R	1-1/16"
2016R	1/2"	2036R	1-1/8"
2018R	9/16"	2038R	1-3/16"
2020R	5/8"	2040R	1-1/4"
2022R	11/16"	2042R	1-5/16"
2024R	3/4"	2044R	1-3/8"
2026R	13/16"	2046R	1-7/16"
2028R	7/8"	2048R	1-1/2"
2030R	15/16"		

Molded Storage Case

6 No. 1319D 1/2" Drive Deep Length Fractional Master Set SAE



This set includes deep length Fractional sizes from 3/8" through 1-1/2". The set is packaged in a convenient molded case with handle for easy transportation. The cover of the case may be removed to allow the bottom to be used as a tool box organizer.

19 piece set contents:



2012D	3/8"	2032D	1"
2014D	7/16"	2034D	1-1/16"
2016D	1/2"	2036D	1-1/8"
2018D	9/16"	2038D	1-3/16"
2020D	5/8"	2040D	1-1/4"
2022D	11/16"	2042D	1-5/16"
2024D	3/4"	2044D	1-3/8"
2026D	13/16"	2046D	1-7/16"
2028D	7/8"	2048D	1-1/2"
2030D	15/16"		

Molded Storage Case



1/2" Drive Metric Impact Socket Master Sets



6 No. 1326M 1/2" Drive Standard Length Metric Master Set



This set includes standard length Metric sizes from 10mm through 36mm. The set is packaged in a convenient molded case with handle for easy transportation. The cover of the case may be removed to allow the bottom to be used as a tool box organizer.



26 piece set contents:

2010M.	10mm	2023M.23mm
2011M.	11mm	2024M.24mm
2012M.	12mm	2025M.25mm
2013M.	13mm	2026M.26mm
2014M.	14mm	2027M.27mm
2015M.	15mm	2028M.28mm
2016M.	16mm	2029M.29mm
2017M.	17mm	2030M.30mm
2018M.	18mm	2032M.32mm
2019M.	19mm	2033M.33mm
2020M.	20mm	2034M.34mm
2021M.	21mm	2035M.35mm
2022M.	22mm	2036M.36mm

Molded Storage Case

6 No. 1326MD 1/2" Drive Deep Length Metric Master Set



This set includes deep length Metric sizes from 10mm through 36mm. The set is packaged in a convenient molded case with handle for easy transportation. The cover of the case may be removed to allow the bottom to be used as a tool box organizer.



26 piece set contents:

2010MD	10mm	2023MD.23mm
2011MD	11mm	2024MD.24mm
2012MD	12mm	2025MD.25mm
2013MD	13mm	2026MD.26mm
2014MD	14mm	2027MD.27mm
2015MD	15mm	2028MD.28mm
2016MD	16mm	2029MD.29mm
2017MD	17mm	2030MD.30mm
2018MD	18mm	2032MD.32mm
2019MD	19mm	2033MD.33mm
2020MD	20mm	2034MD.34mm
2021MD	21mm	2035MD.35mm
2022MD	22mm	2036MD.36mm

Molded Storage Case



1/2" Drive Impact Socket Sets



6 No. 1328RD 1/2" Drive Standard & Deep Length Fractional Set SAE



Set contains both standard & deep length Fractional sizes, plus a universal joint and 3" extension packaged in a molded case for easy transport & storage.

28 piece set contents:



Deep Sizes

2014D 7/16"	2028D 7/8"
2016D 1/2"	2030D 15/16"
2018D 9/16"	2032D 1"
2020D 5/8"	2034D 1-1/16"
2022D 11/16"	2036D 1-1/8"
2024D 3/4"	2040D 1-1/4"
2026D 13/16"		

Standard Sizes

2014R 7/16"	2028R 7/8"
2016R 1/2"	2030R 15/16"
2018R 9/16"	2032R 1"
2020R 5/8"	2034R 1-1/16"
2022R 11/16"	2036R 1-1/8"
2024R 3/4"	2040R 1-1/4"
2026R 13/16"		

- 2229UJ Universal Joint
- 2243E 3" Extension
- Molded Storage Case

1/2"

6 No. 1430MRD 1/2" Drive Standard & Deep Length Metric Set MM



Set contains both standard & deep length Metric sizes, plus a universal joint and 3" extension packaged in a molded case for easy transport & storage.

30 piece set contents:



Deep Sizes

2010MD 10mm	2017MD 17mm
2011MD 11mm	2018MD 18mm
2012MD 12mm	2019MD 19mm
2013MD 13mm	2020MD 20mm
2014MD 14mm	2021MD 21mm
2015MD 15mm	2022MD 22mm
2016MD 16mm	2024MD 24mm

Standard Sizes

2010M 10mm	2017M 17mm
2011M 11mm	2018M 18mm
2012M 12mm	2019M 19mm
2013M 13mm	2020M 20mm
2014M 14mm	2021M 21mm
2015M 15mm	2022M 22mm
2016M 16mm	2024M 24mm

- 2229UJ Universal Joint
- 2243E 3" Extension
- Molded Storage Case



1/2" Drive Impact Socket Sets



6 No. 1324D 1/2" Drive Deep Length Fractional Set SAE



Set contains deep length Fractional sizes from 5/16" through 1-1/2", plus three extensions and a universal joint packaged in a molded case for easy transport and storage.

24 piece set contents:

2010D5/16"	2030D 15/16"
2012D 3/8"	2032D 1"
2014D7/16"	2034D1-1/16"
2016D1/2"	2036D1-1/8"
2018D9/16"	2038D1-3/16"
2020D5/8"	2040D1-1/4"
2022D11/16"	2042D1-5/16"
2024D3/4"	2044D1-3/8"
2026D13/16"	2046D1-7/16"
2028D7/8"	2048D1-1/2"

- 2229UJ 1/2" Universal Joint
- 2243E 3" Extension
- 2245E 5" Extension
- 2210E 10" Extension
- Molded Storage Case



1/2"

6 No. 1512DM* 1/2" Drive Deep Length Fractional & Metric Set SAE MM



Set contains deep length Fractional and Metric sizes, plus two flip sockets and extension for wheel service, packaged in a molded case for easy transport & storage.

30 piece set contents:

Fractional Deep Sizes

2014D7/16"	2028D 7/8"
2016D1/2"	2030D 15/16"
2018D9/16"	2032D 1"
2020D5/8"	2034D1-1/16"
2022D11/16"	2036D1-1/8"
2024D3/4"	2040D1-1/4"
2026D13/16"		

Metric Deep Sizes

2010MD 10mm	2017MD17mm
2011MD 11mm	2018MD18mm
2012MD 12mm	2019MD19mm
2013MD 13mm	2021MD21mm
2014MD 14mm	2022MD22mm
2015MD 15mm	2026MD26mm
2016MD 16mm	2027MD27mm

- 2146DT 3/4" x 13/16" Flip Socket
- 2192DT 19mm x 21mm Flip Socket
- 2243E 3" Extension
- Molded Storage Case

*Pat. No. Des. 392,463





1/2" Drive Extra-Deep Impact Sockets



6 No. 1313XD 1/2" Drive Extra-Deep Length Fractional Set SAE



This set contains Extra-Deep length Fractional sizes for extra reach in extended bolt applications packaged in a molded case for easy transport and storage. Additional Fractional and Metric sizes are available individually.

13 piece set contents:

2016XD	1/2"	2030XD	15/16"
2018XD	9/16"	2032XD	1"
2020XD	5/8"	2034XD	1-1/16"
2022XD	11/16"	2036XD	1-1/8"
2024XD	3/4"	2040XD	1-1/4"
2026XD	13/16"	2042XD	1-5/16"
2028XD	7/8"		Molded Storage Case



1/2"

6 1/2" Drive Extra-Deep Length Fractional Sockets SAE

Five (5) inches overall length, with over 4-3/8" bolt clearance depth.

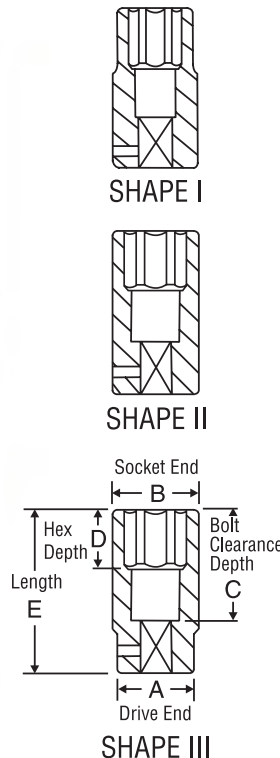

Item Number	Hex Size	Shape	Dimensions (Inches)				
			A	B	C	D	E
2010XD	5/16"	I	.94	.59	4.33	.51	5.00
2012XD	3/8"	I	.94	.63	4.33	.55	5.00
2014XD	7/16"	I	.94	.71	4.33	.55	5.00
2016XD	1/2"	I	.94	.79	4.33	.55	5.00
2018XD	9/16"	I	.94	.87	4.33	.94	5.00
2020XD	5/8"	II	.94	.95	4.33	.94	5.00
2022XD	11/16"	II	1.02	1.02	4.33	.94	5.00
2024XD	3/4"	II	1.10	1.10	4.33	.94	5.00
2026XD	13/16"	II	1.18	1.18	4.33	.94	5.00
2028XD	7/8"	II	1.26	1.26	4.33	.94	5.00
2030XD	15/16"	II	1.34	1.34	4.33	.94	5.00
2032XD	1"	II	1.42	1.42	4.33	.94	5.00
2034XD	1-1/16"	II	1.50	1.50	4.33	.94	5.00
2036XD	1-1/8"	III	1.50	1.58	4.33	.94	5.00
2038XD	1-3/16"	III	1.50	1.65	4.33	.94	5.00
2040XD	1-1/4"	III	1.50	1.73	4.33	.94	5.00
2042XD	1-5/16"	III	1.50	1.81	4.33	.94	5.00
2044XD	1-3/8"	III	1.50	1.91	4.33	.94	5.00
2046XD	1-7/16"	III	1.50	1.99	4.33	.94	5.00
2048XD	1-1/2"	III	1.50	2.07	4.33	.94	5.00



1/2" Drive Extra-Deep Impact Sockets



6 1/2" Drive Extra-Deep Length Metric Sockets ▲ MM

Five (5) inches overall length, with over 4-3/8" bolt clearance depth.

1/2"

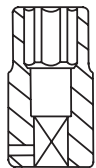

SHAPE I

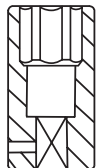

SHAPE II

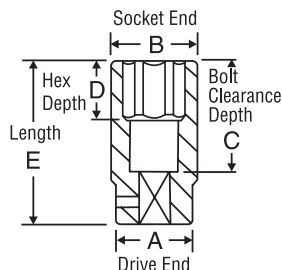

SHAPE III

Item Number	Hex Size	Shape	Dimensions (Millimeters)				
			A	B	C	D	E
2010XMD	10mm	I	24	17.0	110	14	127
2011XMD	11mm	I	24	18.0	110	14	127
2012XMD	12mm	I	24	19.0	110	14	127
2013XMD	13mm	I	24	20.0	110	14	127
2014XMD	14mm	I	24	22.0	110	24	127
2015XMD	15mm	II	24	24.0	110	24	127
2016XMD	16mm	II	24	24.0	110	24	127
2017XMD	17mm	II	26	26.0	110	24	127
2018XMD	18mm	II	26	26.0	110	24	127
2019XMD	19mm	II	28	28.0	110	24	127
2020XMD	20mm	II	30	30.0	110	24	127
2021XMD	21mm	II	30	30.0	110	24	127
2022XMD	22mm	II	32	32.0	110	24	127
2023XMD	23mm	II	32	32.0	110	24	127
2024XMD	24mm	II	34	34.0	110	24	127
2025XMD	25mm	II	36	36.0	110	24	127
2026XMD	26mm	II	36	36.0	110	24	127
2027XMD	27mm	II	38	38.0	110	24	127
2028XMD	28mm	II	38	40.0	110	24	127
2029XMD	29mm	III	38	40.0	110	24	127
2030XMD	30mm	III	38	42.0	110	24	127
2032XMD	32mm	III	38	44.0	110	24	127
2033XMD	33mm	III	38	45.0	110	24	127
2034XMD	34mm	III	38	46.0	110	24	127
2035XMD	35mm	III	38	48.5	110	24	127
2036XMD	36mm	III	38	48.5	110	24	127



1/2" Drive 12-Point Fractional Impact Socket Master Sets



No. 1719

1/2" Drive 12-Point Standard Length Fractional Master Set

SAE



This set includes standard length Fractional sizes from 3/8" through 1-1/2". The set is packaged in a convenient molded case with handle for easy transportation. The cover of the case may be removed to allow the bottom to be used as a tool box organizer.



19 piece set contents:

2112R	3/8"	2132R	1"
2114R	7/16"	2134R	1-1/16"
2116R	1/2"	2136R	1-1/8"
2118R	9/16"	2138R	1-3/16"
2120R	5/8"	2140R	1-1/4"
2122R	11/16"	2142R	1-5/16"
2124R	3/4"	2144R	1-3/8"
2126R	13/16"	2146R	1-7/16"
2128R	7/8"	2148R	1-1/2"
2130R	15/16"		Molded Storage Case

1/2"



No. 1719D

1/2" Drive 12-Point Deep Length Fractional Master Set

SAE



This set includes deep length Fractional sizes from 3/8" through 1-1/2". The set is packaged in a convenient molded case with handle for easy transportation. The cover of the case may be removed to allow the bottom to be used as a tool box organizer.



19 piece set contents:

2112D	3/8"	2132D	1"
2114D	7/16"	2134D	1-1/16"
2116D	1/2"	2136D	1-1/8"
2118D	9/16"	2138D	1-3/16"
2120D	5/8"	2140D	1-1/4"
2122D	11/16"	2142D	1-5/16"
2124D	3/4"	2144D	1-3/8"
2126D	13/16"	2146D	1-7/16"
2128D	7/8"	2148D	1-1/2"
2130D	15/16"		Molded Storage Case





1/2" Drive 12-Point Metric Impact Socket Master Sets



12 No. 1726M 1/2" Drive 12-Point Standard Length Metric Master Set MM



This set includes standard length Metric sizes from 10mm through 36mm. The set is packaged in a convenient molded case with handle for easy transportation. The cover of the case may be removed to allow the bottom to be used as a tool box organizer.

1/2"



26 piece set contents:

2110M.....	10mm	2123M.....	23mm
2111M.....	11mm	2124M.....	24mm
2112M.....	12mm	2125M.....	25mm
2113M.....	13mm	2126M.....	26mm
2114M.....	14mm	2127M.....	27mm
2115M.....	15mm	2128M.....	28mm
2116M.....	16mm	2129M.....	29mm
2117M.....	17mm	2130M.....	30mm
2118M.....	18mm	2132M.....	32mm
2119M.....	19mm	2133M.....	33mm
2120M.....	20mm	2134M.....	34mm
2121M.....	21mm	2135M.....	35mm
2122M.....	22mm	2136M.....	36mm

Molded Storage Case

12 No. 1726MD 1/2" Drive 12-Point Deep Length Metric Master Set MM



This set includes deep length Metric sizes from 10mm through 36mm. The set is packaged in a convenient molded case with handle for easy transportation. The cover of the case may be removed to allow the bottom to be used as a tool box organizer.



26 piece set contents:

2110MD.....	10mm	2123MD.....	23mm
2111MD.....	11mm	2124MD.....	24mm
2112MD.....	12mm	2125MD.....	25mm
2113MD.....	13mm	2126MD.....	26mm
2114MD.....	14mm	2127MD.....	27mm
2115MD.....	15mm	2128MD.....	28mm
2116MD.....	16mm	2129MD.....	29mm
2117MD.....	17mm	2130MD.....	30mm
2118MD.....	18mm	2132MD.....	32mm
2119MD.....	19mm	2133MD.....	33mm
2120MD.....	20mm	2134MD.....	34mm
2121MD.....	21mm	2135MD.....	35mm
2122MD.....	22mm	2136MD.....	36mm

Molded Storage Case



1/2" Drive Universal Impact Socket Sets



6 No. 1314U 1/2" Drive Standard Length Fractional Universal Set SAE



14 piece set contents:

2014U	7/16"	2028U	7/8"
2016U	1/2"	2030U	15/16"
2018U	9/16"	2032U	1"
2020U	5/8"	2034U	1-1/16"
2022U	11/16"	2036U	1-1/8"
2024U	3/4"	2038U	1-3/16"
2026U	13/16"	2040U	1-1/4"

Molded Storage Case

1/2"

6 No. 1314UD 1/2" Drive Deep Length Fractional Universal Set SAE



14 piece set contents:

2014UD	7/16"	2028UD	7/8"
2016UD	1/2"	2030UD	15/16"
2018UD	9/16"	2032UD	1"
2020UD	5/8"	2034UD	1-1/16"
2022UD	11/16"	2036UD	1-1/8"
2024UD	3/4"	2038UD	1-3/16"
2026UD	13/16"	2040UD	1-1/4"

Molded Storage Case

6 No. 1313UM 1/2" Drive Standard Length Metric Universal Set MM



13 piece set contents:

2012UM	12mm	2019UM	19mm
2013UM	13mm	2020UM	20mm
2014UM	14mm	2021UM	21mm
2015UM	15mm	2022UM	22mm
2016UM	16mm	2023UM	23mm
2017UM	17mm	2024UM	24mm
2018UM	18mm		

Molded Storage Case

6 No. 1313UMD 1/2" Drive Deep Length Metric Universal Set MM



13 piece set contents:

2012UMD	12mm	2019UMD	19mm
2013UMD	13mm	2020UMD	20mm
2014UMD	14mm	2021UMD	21mm
2015UMD	15mm	2022UMD	22mm
2016UMD	16mm	2023UMD	23mm
2017UMD	17mm	2024UMD	24mm
2018UMD	18mm		

Molded Storage Case



1/2" Drive 12-Point Universal Impact Socket Sets



12 No. 1714U 1/2" Drive 12-Point Standard Length Fractional Universal Set SAE



1/2"

14 piece set contents:

2114U.....	7/16"	2128U.....	7/8"
2116U.....	1/2"	2130U.....	15/16"
2118U.....	9/16"	2132U.....	1"
2120U.....	5/8"	2134U.....	1-1/16"
2122U.....	11/16"	2136U.....	1-1/8"
2124U.....	3/4"	2138U.....	1-3/16"
2126U.....	13/16"	2140U.....	1-1/4"

Molded Storage Case



12 No. 1713UM 1/2" Drive 12-Point Standard Length Metric Universal Set MM



13 piece set contents:

2112UM.....	12mm	2119UM.....	19mm
2113UM.....	13mm	2120UM.....	20mm
2114UM.....	14mm	2121UM.....	21mm
2115UM.....	15mm	2122UM.....	22mm
2116UM.....	16mm	2123UM.....	23mm
2117UM.....	17mm	2124UM.....	24mm
2118UM.....	18mm		

Molded Storage Case





1/2" Drive Magnetic Impact Socket Sets



No. 1511G 1/2" Drive Standard Length Fractional Magnetic Set SAE



11 piece set contents:

2012RG.....	3/8"	2022RG.....	11/16"
2014RG.....	7/16"	2024RG.....	3/4"
2016RG.....	1/2"	2026RG.....	13/16"
2018RG.....	9/16"	2028RG.....	7/8"
2020RG.....	5/8"	2030RG.....	15/16"
	On a Metal Clip Rail	2032RG.....	1"

1/2"

No. 1512MG 1/2" Drive Standard Length Metric Magnetic Set MM



12 piece set contents:

2010MG.....	.10mm	2016MG.....	.16mm
2011MG.....	.11mm	2017MG.....	.17mm
2012MG.....	.12mm	2018MG.....	.18mm
2013MG.....	.13mm	2019MG.....	.19mm
2014MG.....	.14mm	2020MG.....	.20mm
2015MG.....	.15mm	2021MG.....	.21mm
			On a Metal Clip Rail

No. 1511DG 1/2" Drive Deep Length Fractional Magnetic Set SAE

These magnetic sockets feature a spring loaded magnet that retracts into the socket for extended bolt applications.



11 piece set contents:

2012DG.....	3/8"	2022DG.....	11/16"
2014DG.....	7/16"	2024DG.....	3/4"
2016DG.....	1/2"	2026DG.....	13/16"
2018DG.....	9/16"	2028DG.....	7/8"
2020DG.....	5/8"	2030DG.....	15/16"
	On a Metal Clip Rail	2032DG.....	1"

No. 1512MDG 1/2" Drive Deep Length Metric Magnetic Set MM

These magnetic sockets feature a spring loaded magnet that retracts into the socket for extended bolt applications.



12 piece set contents:

2010MDG.....	.10mm	2016MDG.....	.16mm
2011MDG.....	.11mm	2017MDG.....	.17mm
2012MDG.....	.12mm	2018MDG.....	.18mm
2013MDG.....	.13mm	2019MDG.....	.19mm
2014MDG.....	.14mm	2020MDG.....	.20mm
2015MDG.....	.15mm	2021MDG.....	.21mm
			On a Metal Clip Rail



1/2" Drive 8-Point Standard Length Impact Sockets



8 No. 1311S 1/2" Drive 8-Point Standard Length Fractional Socket Set SAE



Set contains eleven (11) 8-point standard length sockets packaged in a molded case for easy transportation and storage. These sockets are commonly referred to as double-square or railroad sockets. Available individually below.

11 piece set contents:

2516S 1/2"	2528S 7/8"
2518S 9/16"	2530S 15/16"
2520S 5/8"	2532S 1"
2522S 11/16"	2534S 1-1/16"
2524S 3/4"	2536S 1-1/8"
2526S 13/16"		Molded Storage Case



8 1/2" Drive 8-Point - Standard Length - Fractional Sizes SAE

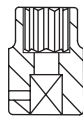

SHAPE I

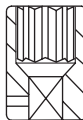

SHAPE II

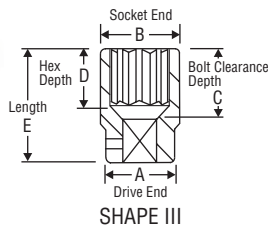

SHAPE III

Item Number	8-Point Size	Shape	Dimensions (Inches)				
			A	B	C	D	E
2516S	1/2"	II	.94	.94	.83	.35	1.50
2518S	9/16"	II	1.02	1.02	.83	.43	1.50
2520S	5/8"	II	1.10	1.10	.83	.43	1.50
2522S	11/16"	II	1.18	1.18	.83	.43	1.50
2524S	3/4"	II	1.34	1.34	.91	.51	1.57
2526S	13/16"	II	1.42	1.42	.91	.59	1.57
2528S	7/8"	II	1.50	1.50	.91	.59	1.57
2530S	15/16"	III	1.50	1.65	1.10	.71	1.77
2532S	1"	III	1.50	1.73	1.10	.71	1.77
2534S	1-1/16"	II	1.83	1.83	1.30	.75	1.97
2536S	1-1/8"	II	1.93	1.93	1.30	.75	1.97



1/2" Drive 8-Point Deep Length Impact Sockets



8 No. 1311SD 1/2" Drive 8-Point Deep Length Fractional Socket Set SAE



Set contains eleven (11) 8-point deep length sockets packaged in a molded case for easy transportation and storage. These sockets are commonly referred to as double-square or railroad sockets. Available individually below.

11 piece set contents:

2516SD 1/2"	2528SD 7/8"
2518SD 9/16"	2530SD 15/16"
2520SD 5/8"	2532SD 1"
2522SD 11/16"	2534SD 1-1/16"
2524SD 3/4"	2536SD 1-1/8"
2526SD 13/16"	Molded Storage Case

1/2"



8 1/2" Drive 8-Point - Deep Length - Fractional Sizes SAE

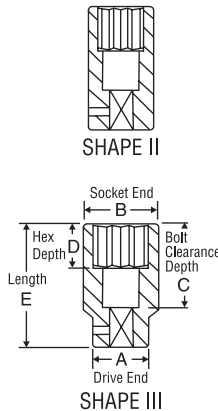

Item Number	8-Point Size	Shape	Dimensions (Inches)				
			A	B	C	D	E
2516SD	1/2"	II	.94	.94	2.60	.35	3.27
2518SD	9/16"	II	1.02	1.02	2.60	.43	3.27
2520SD	5/8"	II	1.10	1.10	2.60	.43	3.27
2522SD	11/16"	II	1.18	1.18	2.60	.43	3.27
2524SD	3/4"	II	1.34	1.34	2.60	.51	3.27
2526SD	13/16"	II	1.42	1.42	2.60	.59	3.27
2528SD	7/8"	II	1.50	1.50	2.87	.59	3.54
2530SD	15/16"	III	1.50	1.65	2.87	.71	3.54
2532SD	1"	III	1.50	1.73	2.87	.71	3.54
2534SD	1-1/16"	III	1.83	1.83	2.87	.75	3.54
2536SD	1-1/8"	III	1.93	1.93	2.87	.75	3.54



1/2" Drive Pipe Plug Impact Sockets



4 No. 1308P 1/2" Drive Pipe Plug Socket Set SAE



8 piece set contents:

Male Sizes

2008PP 1/4"
 2009PP 9/32"
 2010PP 5/16"
 2012PP 3/8"

2014PP 7/16"
 2016PP 1/2"
 2018PP 9/16"
 2020PP 5/8"

Molded Storage Case



4 1/2" Drive Individual Male Pipe Plug Sockets SAE

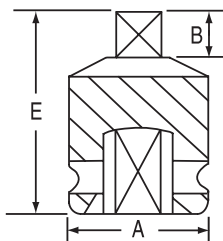

Item Number	Male Size	Dimensions (Inches)		
		A	B	E
2008PP	1/4"	.98	.32	1.50
2009PP	9/32"	.98	.32	1.50
2010PP	5/16"	.98	.32	1.50
2012PP	3/8"	.98	.32	1.50
2014PP	7/16"	.98	.32	1.50
2016PP	1/2"	.98	.32	1.50
2018PP	9/16"	1.02	.32	1.50
2020PP	5/8"	1.14	.32	1.50



1/2" Drive Axle/Spindle Nut Impact Sockets



6 No. 1705SN 1/2" Drive Axle/Spindle Nut Socket Set MM

This set contains five (5) popular axle/spindle nut impact socket sizes. Packaged in a convenient molded case.



5 piece set contents:

2730MD 30mm Deep
2732MD 32mm Deep
2734MD 34mm Deep

2735MD. . . . 35mm Deep
2736MD. . . . 36mm Deep
Molded Storage Case

1/2"



6 1/2" Drive Axle/Spindle Nut Impact Sockets MM

These sockets are designed specifically to remove axle/spindle nuts on passenger and light trucks and are of a heavy duty design. They are also useful in any application that requires a heavy duty socket.

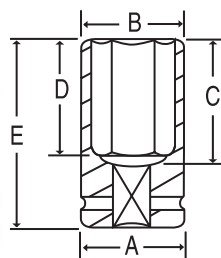

Item Number	Hex Size	Dimensions (Millimeters)				
		A	B	C	D	E
2730MD	30mm	43	43	72	21.5	89
2732MD	32mm	43	45	72	21.5	89
2734MD	34mm	43	48	72	21.5	89
2735MD	35mm	43	50	72	21.5	89
2736MD	36mm	43	52	72	21.5	89



1/2" Drive 12-Point Axle/Spindle Nut Impact Sockets



12 No. 1708SN 1/2" Drive - 12 Point - Axle/Spindle Nut Socket Set MM

This set contains eight (8) popular 12 point axle/spindle nut impact socket sizes. Fits axle nuts on Toyota Tundra, Sequoia, Tacoma and Lexus LX570 as well as most other vehicles. Packaged in a convenient molded case with handle.



8 piece set contents:

- 2129MD 29mm Deep
- 2130MD 30mm Deep
- 2132MD 32mm Deep
- 2134MD 34mm Deep
- 2135MD 35mm Deep
- 2136MD 36mm Deep
- 2138MD 38mm Deep
- 2139MD 39mm Deep
- Molded Storage Case



12 1/2" Drive - 12 Point - Axle/Spindle Nut Impact Sockets MM

These sockets are specifically designed to remove Axle/Spindle nuts on passenger cars and light trucks.

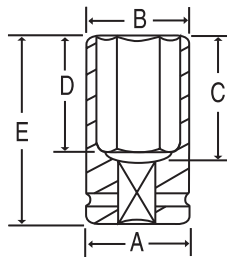

Item Number	12-Point Size	Dimensions (Millimeters)				
		A	B	C	D	E
2129MD	29mm	38	40	73	24	90
2130MD	30mm	38	42	73	24	90
2132MD	32mm	38	44	73	24	90
2134MD	34mm	38	46	73	36	90
2135MD	35mm	38	48.5	73	36	90
2136MD	36mm	38	48.5	73	36	90
2138MD	38mm	38	52.5	73	36	90
2139MD	39mm	44	54.5	76	36	93



1/2" Drive Wheel Service Impact Sockets



6 No. 1504FW 1/2" Drive Thin Wall "Flip" Socket Set SAE MM



A set of four (4) thin wall "flip" style impact sockets that have two different hex sizes in each socket. Sockets are designed for auto and light truck wheel fasteners. Use with 1/2" drive extended shank impact tools or regular shank impact tools with an extension.

4 piece set contents:

2346D 3/4" x 13/16"	2349D . . . 7/8"/ 22mm x 15/16"/ 24mm
2392D 19mm x 21mm	2351D 1" x 1-1/16"

Plastic Tray

All items in this set carry the GP Lifetime Warranty.

1/2"

6 1/2" Drive Extra-Thin Wall "Flip" Sockets SAE MM

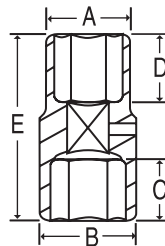

Unique hex opening on each end so that a single socket can accommodate two hex sizes. Extra-thin wall design for easy access to recessed wheel nuts.

Item Number	Hex Size	Dimensions (Inches)				
		A	B	C	D	E
*2146DT	3/4" x 13/16"	1.02	1.10	1.06	.90	2.99
*2192DT	19mm x 21mm	1.02	1.10	1.06	.90	2.99

*Extra-Thin Wall Impact Sockets are not covered by the GP Warranty.

6 1/2" Drive Thin Wall "Flip" Sockets SAE MM

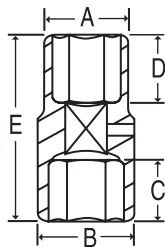

Unique hex opening on each end so that a single socket can accommodate two hex sizes. Thin wall design to fit most recessed wheel nuts.

Item Number	Hex Size	Dimensions (Inches)				
		A	B	C	D	E
2346D	3/4" x 13/16"	1.10	1.18	1.06	.90	2.99
2392D	19mm x 21mm	1.10	1.18	1.06	.90	2.99
2349D	7/8"/22mm x 15/16"/24mm	1.25	1.33	1.20	1.00	3.26
2351D	1" x 1-1/16"	1.41	1.49	1.20	1.00	3.26

GP Lifetime Warranty

6 1/2" Drive Damaged Nut "Flip" Sockets MM



These sockets are designed to remove lug nuts with missing, damaged, or distorted caps. "Flip" Design is for use with extended anvil impact wrenches or with an extension.

Item Number	Hex Size	Dimensions (Inches)				
		A	B	C	D	E
2189D	18.5mm x 19.5mm	1.10	1.18	1.06	.90	2.99
2190D	21mm x 21.5mm	1.22	1.24	1.20	1.00	3.26
2191D	22mm x 22.5mm	1.24	1.26	1.20	1.00	3.26

GP Lifetime Warranty



1/2" Drive Extra-Thin Wall Wheel Service Impact Sockets

6 1500DW* 1/2" Drive Extra-Thin Wall Set For Wheel Service SAE MM



Twelve (12) - 1/2" drive extra-thin wall designed deep fractional and metric impact sockets. The extra-thin wall design allows easy access to recessed wheel nuts where space is limited. Due to the extra-thin wall design, they should only be used on wheel nuts where limited torque is applied. For use only with 1/2" drive tools. DO NOT use reducing adapters.

12 piece set contents:

2024DT 3/4" T.W.	2017MDT 17mm T.W.
2026DT 13/16" T.W.	2019MDT 19mm T.W.
2028DT 7/8" T.W.	2021MDT 21mm T.W.
2032DT 1" T.W.	2022MDT 22mm T.W.
2034DT 1-1/16" T.W.	2023MDT 23mm T.W.
2146DT . . . 3/4" x 13/16" T.W.	2192DT . . 19mm x 21mm T.W.

Molded Storage Case

*Extra-Thin Wall Impact Sockets are not covered by the GP Warranty.



1/2"

6 1/2" Drive Extra-Thin Wall Sockets SAE MM



These extra-thin wall deep impact sockets are designed to allow easy access to recessed wheel nuts where space is limited. Due to the extra-thin wall design, they should be used only on passenger and light truck wheel nuts. Use Only with 1/2" Drive Tools. DO NOT use with reducing adapters.

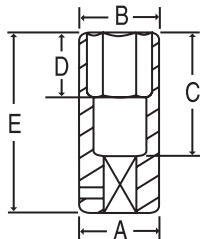

Item Number	Hex Size	Dimensions (Inches)				
		A	B	C	D	E
Fractional Sizes						
*2024DT	3/4"	1.02	1.02	2.40	.75	3.07
*2026DT	13/16"	1.10	1.10	2.40	.94	3.07
*2028DT	7/8"	1.18	1.18	2.40	.94	3.07
*2030DT	15/16"	1.26	1.26	2.40	.94	3.07
*2032DT	1"	1.34	1.34	2.40	.94	3.07
*2034DT	1-1/16"	1.42	1.42	2.40	.94	3.07
Metric Sizes						
*2017MDT	17mm	.95	.95	1.58	.67	3.07
*2019MDT	19mm	1.02	1.02	1.58	.75	3.07
*2021MDT	21mm	1.10	1.10	1.58	.95	3.07
*2022MDT	22mm	1.16	1.16	1.58	.95	3.07
*2023MDT	23mm	1.20	1.20	1.58	.95	3.07

*Extra-Thin Wall Impact Sockets are not covered by the GP Warranty.

1/2" Drive Wheel/Nut Protector Impact Sockets



6 1/2" Drive Extra-Thin Wall Wheel/Nut Protector Sockets SAE MM

These unique extra-thin wall impact sockets are for use on alloy wheels with decorative lug nuts. They feature protective (color-coded) plastic sleeves and internal plastic inserts to prevent damage to expensive alloy wheels and decorative lug nuts. They should be used only on passenger and light truck wheel nuts. USE ONLY WITH 1/2" DRIVE AIR TOOLS. DO NOT USE REDUCING ADAPTERS. Available individually or in Sets below.

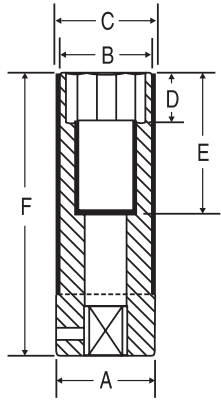

*Extra-Thin Wall Impact Sockets are not covered by the GP Warranty.

Item Number	Hex Size	Sleeve Color	Dimensions (Inches)					
			A	B	C	D	E	F
Fractional Sizes								
*2024TP	3/4"	Yellow	1.10	1.02	1.10	.71	1.75	3.15
*2026TP	13/16"	Dark Green	1.18	1.10	1.18	.91	1.75	3.15
*2028TP	7/8"	Purple	1.26	1.18	1.26	.91	1.75	3.15
*2030TP	15/16"	Tan	1.34	1.26	1.26	.91	1.75	3.07
*2032TP	1"	Light Blue	1.42	1.34	1.34	.91	1.75	3.07
*2034TP	1-1/16"	Light Green	1.50	1.42	1.42	.91	1.75	3.07
Metric Sizes								
*2017MTP	17mm	Red	1.02	.95	1.02	.63	1.75	3.15
*2019MTP	19mm	Dark Blue	1.10	1.02	1.10	.71	1.75	3.15
*2021MTP	21mm	Gray	1.18	1.10	1.18	.91	1.75	3.15
*2022MTP	22mm	Orange	1.26	1.16	1.24	.91	1.75	3.15
*2023MTP	23mm	Brown	1.26	1.20	1.28	.91	1.75	3.15

1/2"

6 No. 1511TP* 1/2" Drive Extra-Thin Wall Wheel/Nut Protector Socket Set SAE MM



*Extra-Thin Wall Impact Sockets are not covered by the GP Warranty.

11 piece set contents: (All Impact Sockets listed above)

2024TP 3/4"	2017MTP 17mm
2026TP 13/16"	2019MTP 19mm
2028TP 7/8"	2021MTP 21mm
2030TP 15/16"	2022MTP 22mm
2032TP 1"	2023MTP 23mm
2034TP 1-1/16"		Molded Storage Case

6 No. 1503TP* 1/2" Drive Extra-Thin Wall Wheel/Nut Protector Socket Set MM



*Extra-Thin Wall Impact Sockets are not covered by the GP Warranty.

Set includes three (3) of the most popular metric sizes listed above:

3 piece set contents:

17mm, 19mm, 21mm
Molded Storage Case

No. 2017MF 1/2" Drive x 17mm Mercedes Wheel Lug Socket MM



Specifically designed for use on flower type wheel bolts found on Mercedes C-Class/GLK (W204), E-Class (W211, W212, W207), SLK (W172), M-Class (W164, W166), CL-Class (W216), S-Class (W221, W222) & Maybach

Features include:

- Socket features a replaceable protective sleeve to prevent damage to wheels.
- GP Lifetime Warranty (socket only)

Replacement Sleeves:

- 2017RS - 5 pack Replacement Sleeves



1/2" Drive Standard Length Impact Sockets



6 1/2" Drive - Standard Length - Fractional Sizes SAE



ANSI Specifications B107.2

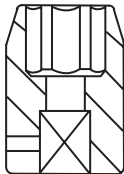

SHAPE I

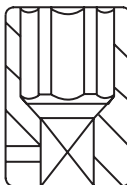

SHAPE II

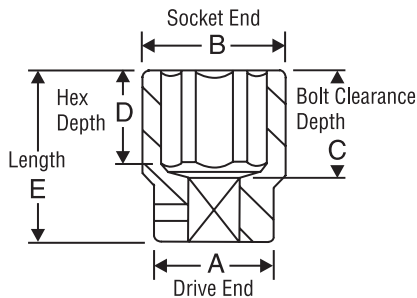

SHAPE III

Item Number	Hex Size	Shape	Dimensions (Inches)				
			A	B	C	D	E
2010R	5/16"	I	.87	.59	.83	.35	1.50
2012R	3/8"	I	.87	.63	.83	.47	1.50
2014R	7/16"	I	.87	.71	.83	.47	1.50
2016R	1/2"	I	.87	.79	.83	.47	1.50
2018R	9/16"	I	.94	.87	.83	.47	1.50
2020R	5/8"	II	.98	.98	.83	.47	1.50
2022R	11/16"	II	1.02	1.02	.83	.51	1.50
2024R	3/4"	II	1.10	1.10	.83	.51	1.50
2026R	13/16"	II	1.18	1.18	.83	.55	1.50
2028R	7/8"	II	1.26	1.26	.83	.59	1.50
2030R	15/16"	II	1.34	1.34	.83	.59	1.50
2032R	1"	II	1.42	1.42	.83	.59	1.50
2034R	1-1/16"	II	1.50	1.50	.91	.67	1.57
2036R	1-1/8"	III	1.50	1.57	.91	.67	1.57
2038R	1-3/16"	III	1.50	1.65	.91	.67	1.57
2040R	1-1/4"	III	1.50	1.73	.91	.67	1.57
2042R	1-5/16"	III	1.50	1.77	1.02	.75	1.69
2044R	1-3/8"	III	1.50	1.91	1.30	.94	1.97
2046R	1-7/16"	III	1.50	1.99	1.30	.94	1.97
2048R	1-1/2"	III	1.50	2.07	1.30	.94	1.97
2050R	1-9/16"	III	1.73	2.20	1.69	.94	2.36
2052R	1-5/8"	III	1.73	2.30	1.69	1.06	2.36
2054R	1-11/16"	III	1.73	2.40	1.69	1.06	2.36
2056R	1-3/4"	III	1.73	2.48	1.69	1.06	2.36
2058R	1-13/16"	III	1.73	2.56	2.09	1.18	2.76
2060R	1-7/8"	III	1.73	2.66	2.09	1.18	2.76
2062R	1-15/16"	III	1.73	2.72	2.09	1.18	2.76
2064R	2"	III	2.05	2.80	2.09	1.26	2.76
2066R	2-1/16"	III	2.05	2.85	2.09	1.26	2.76
2068R	2-1/8"	III	2.05	2.95	2.09	1.26	2.76
2070R	2-3/16"	III	2.05	3.01	2.09	1.38	2.76
2072R	2-1/4"	III	2.05	3.07	2.09	1.38	2.76

6 Standard Length - Metric Sizes MM

Item Number	Hex Size	Shape	Dimensions (Millimeters)				
			A	B	C	D	E
2008M	8mm	I	22	15.0	21	9	38
2009M	9mm	I	22	15.0	21	12	38
2010M	10mm	I	22	17.0	21	12	38
2011M	11mm	I	22	19.0	21	12	38
2012M	12mm	I	22	19.0	21	12	38
2013M	13mm	I	24	20.0	21	12	38
2014M	14mm	I	24	22.0	21	12	38
2015M	15mm	I	25	23.0	21	12	38
2016M	16mm	II	25	25.0	21	12	38
2017M	17mm	II	26	26.0	21	13	38
2018M	18mm	II	26	26.0	21	13	38
2019M	19mm	II	28	28.0	21	13	38
2020M	20mm	II	30	30.0	21	13	38
2021M	21mm	II	30	30.0	21	13	38
2022M	22mm	II	32	32.0	21	13	38
2023M	23mm	II	32	32.0	21	13	38
2024M	24mm	II	34	34.0	21	13	38
2025M	25mm	II	36	36.0	21	14	38
2026M	26mm	II	36	36.0	21	14	38
2027M	27mm	II	38	38.0	23	17	40
2028M	28mm	III	38	40.0	23	17	40
2029M	29mm	III	38	40.0	23	17	40
2030M	30mm	III	38	42.0	23	17	40
2032M	32mm	III	38	44.0	23	17	40
2033M	33mm	III	38	45.0	26	19	43
2034M	34mm	III	38	46.0	33	24	50
2035M	35mm	III	38	48.5	33	24	50
2036M	36mm	III	38	48.5	33	24	50



1/2" Drive Deep Length Impact Sockets



6 1/2" Drive - Deep Length - Fractional Sizes SAE



ANSI Specifications B107.2

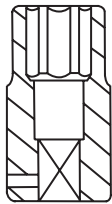

SHAPE I

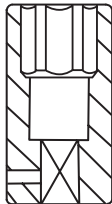

SHAPE II

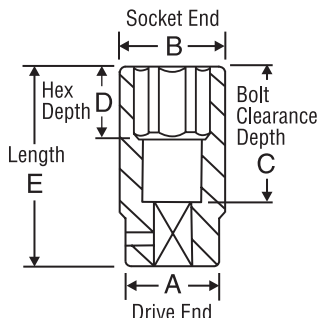

SHAPE III

Item Number	Hex Size	Shape	Dimensions (Inches)				
			A	B	C	D	E
2010D	5/16"	I	.87	.59	2.65	.51	3.27
2012D	3/8"	I	.87	.63	2.65	.55	3.27
2014D	7/16"	I	.87	.71	2.65	.55	3.27
2016D	1/2"	I	.87	.79	2.65	.55	3.27
2018D	9/16"	I	.94	.87	2.65	.95	3.27
2020D	5/8"	II	.94	.94	2.65	.95	3.27
2022D	11/16"	II	1.02	1.02	2.65	.95	3.27
2024D	3/4"	II	1.10	1.10	2.65	.95	3.27
2026D	13/16"	II	1.18	1.18	2.65	.95	3.27
2028D	7/8"	II	1.26	1.26	2.92	.95	3.54
2030D	15/16"	II	1.34	1.34	2.92	.95	3.54
2032D	1"	II	1.42	1.42	2.92	.95	3.54
2034D	1-1/16"	II	1.50	1.50	2.92	.95	3.54
2036D	1-1/8"	III	1.50	1.57	2.92	.95	3.54
2038D	1-3/16"	III	1.50	1.73	2.92	.95	3.54
2040D	1-1/4"	III	1.50	1.73	2.92	.95	3.54
*2040HD	1-1/4"	III	1.50	1.85	2.68	1.22	3.35
2042D	1-5/16"	III	1.50	1.77	2.92	1.35	3.54
2044D	1-3/8"	III	1.50	1.91	2.92	1.35	3.54
2046D	1-7/16"	III	1.50	1.99	2.92	1.35	3.54
2048D	1-1/2"	III	1.50	2.07	2.92	1.45	3.54
2050D	1-9/16"	III	1.73	2.20	3.03	2.28	3.66
2052D	1-5/8"	III	1.73	2.30	3.03	2.28	3.66
2054D	1-11/16"	III	1.73	2.40	3.03	2.28	3.66
2056D	1-3/4"	III	1.73	2.48	3.03	2.28	3.66
2058D	1-13/16"	III	1.73	2.56	3.03	2.28	3.66
2060D	1-7/8"	III	1.73	2.66	3.03	2.28	3.66
2062D	1-15/16"	III	1.73	2.72	3.03	2.28	3.66
2064D	2"	III	2.05	2.80	3.03	2.28	3.66
2066D	2-1/16"	III	2.05	2.85	3.03	2.28	3.66
2068D	2-1/8"	III	2.05	2.95	3.03	2.28	3.66
2070D	2-3/16"	III	2.05	3.01	3.03	2.28	3.66
2072D	2-1/4"	III	2.05	3.07	3.03	2.28	3.66

*For Heavy Duty Wheel Service Work

6 Deep Length - Metric Sizes MM

Item Number	Hex Size	Shape	Dimensions (Millimeters)				
			A	B	C	D	E
2008MD	8mm	I	22	15.0	66	14	83
2009MD	9mm	I	22	15.0	66	14	83
2010MD	10mm	I	22	17.0	66	14	83
2011MD	11mm	I	22	18.0	66	14	83
2012MD	12mm	I	22	19.0	66	14	83
2013MD	13mm	I	24	20.0	66	14	83
2014MD	14mm	I	24	22.0	66	24	83
2015MD	15mm	II	24	24.0	66	24	83
2016MD	16mm	II	26	24.0	66	24	83
2017MD	17mm	II	26	26.0	66	24	83
2018MD	18mm	II	26	26.0	66	24	83
2019MD	19mm	II	28	28.0	66	24	83
2020MD	20mm	II	30	30.0	66	24	83
2021MD	21mm	II	30	30.0	66	24	83
2022MD	22mm	II	32	32.0	73	24	90
2023MD	23mm	II	32	32.0	73	24	90
2024MD	24mm	II	34	34.0	73	24	90
2025MD	25mm	II	36	36.0	73	24	90
2026MD	26mm	II	36	36.0	73	24	90
2027MD	27mm	II	38	38.0	73	24	90
2028MD	28mm	III	38	40.0	73	24	90
2029MD	29mm	III	38	40.0	73	24	90
2030MD	30mm	III	38	42.0	73	24	90
2032MD	32mm	III	38	44.0	73	24	90
2033MD	33mm	III	38	45.0	73	34	90
2034MD	34mm	III	38	46.0	73	34	90
2035MD	35mm	III	38	48.5	73	34	90
2036MD	36mm	III	38	48.5	73	34	90



1/2" Drive 12-Point Standard Length Impact Sockets



12 1/2" Drive 12-Point - Standard Length - Fractional Sizes SAE



Item Number	12-Point Size	Shape	Dimensions (Inches)				
			A	B	C	D	E
2112R	3/8"	I	.94	.63	.83	.47	1.50
2114R	7/16"	I	.94	.71	.83	.47	1.50
2116R	1/2"	I	.94	.79	.83	.47	1.50
2118R	9/16"	I	.94	.87	.83	.47	1.50
2120R	5/8"	I	.94	.94	.83	.47	1.50
2122R	11/16"	II	.94	1.02	.83	.51	1.50
2124R	3/4"	II	1.02	1.10	.83	.51	1.50
2126R	13/16"	II	1.10	1.18	.83	.55	1.50
2128R	7/8"	II	1.18	1.26	.83	.59	1.50
2130R	15/16"	II	1.26	1.34	1.10	.79	1.77
2132R	1"	II	1.34	1.42	1.10	.79	1.77
2134R	1-1/16"	II	1.42	1.50	1.30	.94	1.97
2136R	1-1/8"	III	1.50	1.56	1.30	.94	1.97
2138R	1-3/16"	III	1.50	1.64	1.30	.94	1.97
2140R	1-1/4"	III	1.50	1.72	1.30	.94	1.97
2142R	1-5/16"	III	1.50	1.75	1.30	.94	1.97
2144R	1-3/8"	III	1.50	1.84	1.30	.94	1.97
2146R	1-7/16"	III	1.50	1.90	1.30	.94	1.97

ANSI Specifications B107.2

12 Standard Length - Metric Sizes MM

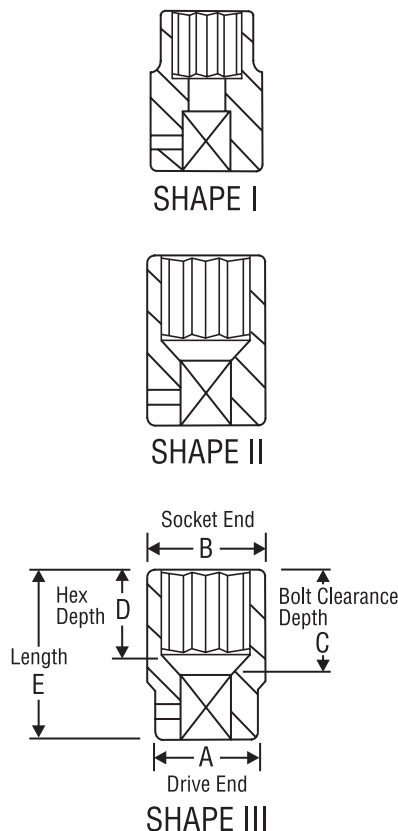

Item Number	12-Point Size	Shape	Dimensions (Millimeters)				
			A	B	C	D	E
2110M	10mm	I	24	17	21	12	38
2111M	11mm	I	24	18	21	12	38
2112M	12mm	I	24	19	21	12	38
2113M	13mm	I	24	20	21	12	38
2114M	14mm	I	24	22	21	12	38
2115M	15mm	II	24	24	21	12	38
2116M	16mm	II	24	24	21	12	38
2117M	17mm	II	26	26	21	13	38
2118M	18mm	II	26	26	21	13	38
2119M	19mm	II	28	28	21	13	38
2120M	20mm	II	30	30	21	14	38
2121M	21mm	II	30	30	21	14	38
2122M	22mm	II	32	32	21	15	38
2123M	23mm	II	32	32	21	15	38
2124M	24mm	II	34	34	28	20	45
2125M	25mm	II	36	36	28	20	45
2126M	26mm	II	36	36	33	24	50
2127M	27mm	II	38	38	33	24	50
2128M	28mm	III	38	40	33	24	50
2129M	29mm	III	38	40	33	24	50
2130M	30mm	III	38	42	33	24	50
2132M	32mm	III	38	44	33	24	50
2133M	33mm	III	38	45	33	24	50
2134M	34mm	III	38	46	33	24	50
2135M	35mm	III	38	47	33	24	50
2136M	36mm	III	38	48	33	24	50



1/2" Drive 12-Point Deep Length Impact Sockets



12 1/2" Drive 12-Point - Deep Length - Fractional Sizes SAE



Item Number	12-Point Size	Shape	Dimensions (Inches)				
			A	B	C	D	E
2112D	3/8"	I	.87	.63	2.60	.55	3.27
2114D	7/16"	I	.87	.71	2.60	.55	3.27
2116D	1/2"	I	.87	.79	2.60	.55	3.27
2118D	9/16"	I	.94	.87	2.60	.94	3.27
2120D	5/8"	II	.94	.94	2.60	.94	3.27
2122D	11/16"	II	1.02	1.02	2.60	.94	3.27
2124D	3/4"	II	1.10	1.10	2.60	.94	3.27
2126D	13/16"	II	1.18	1.18	2.60	.94	3.27
2128D	7/8"	II	1.26	1.26	2.87	.94	3.54
2130D	15/16"	II	1.34	1.34	2.87	.94	3.54
2132D	1"	II	1.42	1.42	2.87	.94	3.54
2134D	1-1/16"	II	1.50	1.50	2.87	.94	3.54
2136D	1-1/8"	III	1.50	1.57	2.87	.94	3.54
2138D	1-3/16"	III	1.50	1.65	2.87	.94	3.54
2140D	1-1/4"	III	1.50	1.73	2.87	.94	3.54
2142D	1-5/16"	III	1.50	1.77	2.87	.94	3.54
2144D	1-3/8"	III	1.50	1.91	2.87	.94	3.54
2146D	1-7/16"	III	1.50	1.99	2.87	.94	3.54
2148D	1-1/2"	III	1.50	2.07	2.87	.94	3.54

ANSI Specifications B107.2

12 Deep Length - Metric Sizes MM

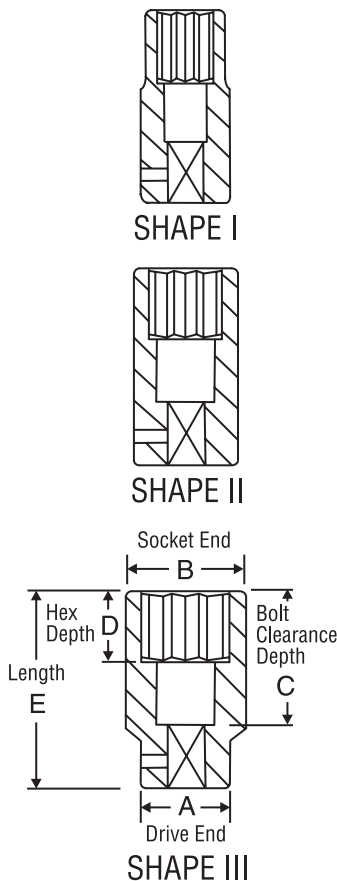

Item Number	12-Point Size	Shape	Dimensions (Millimeters)				
			A	B	C	D	E
2110MD	10mm	I	22	17.0	66	14	83
2111MD	11mm	I	22	18.0	66	14	83
2112MD	12mm	I	22	19.0	66	14	83
2113MD	13mm	I	24	20.0	66	14	83
2114MD	14mm	I	24	22.0	66	24	83
2115MD	15mm	II	24	24.0	66	24	83
2116MD	16mm	II	24	24.0	66	24	83
2117MD	17mm	II	26	26.0	66	24	83
2118MD	18mm	II	26	26.0	66	24	83
2119MD	19mm	II	28	28.0	66	24	83
2120MD	20mm	II	30	30.0	66	24	83
2121MD	21mm	II	30	30.0	66	24	83
2122MD	22mm	II	32	32.0	73	24	90
2123MD	23mm	II	32	32.0	73	24	90
2124MD	24mm	II	34	34.0	73	24	90
2125MD	25mm	II	36	36.0	73	24	90
2126MD	26mm	II	36	36.0	73	24	90
2127MD	27mm	II	38	38.0	73	24	90
2128MD	28mm	III	38	40.0	73	24	90
2129MD	29mm	III	38	40.0	73	24	90
2130MD	30mm	III	38	42.0	73	24	90
2132MD	32mm	III	38	44.0	73	24	90
2133MD	33mm	III	38	45.0	73	36	90
2134MD	34mm	III	38	46.0	73	36	90
2135MD	35mm	III	38	48.5	73	36	90
2136MD	36mm	III	38	48.5	73	36	90
2138MD	38mm	III	38	52.5	73	36	90
2139MD	39mm	III	44	54.5	76	36	93



1/2" Drive Standard Length Universal Impact Sockets



6 1/2" Drive - Standard Length Universal - Fractional Sizes SAE



1/2"

Item Number	Hex Size	Dimensions (Inches)				
		A	B	C	D	E
2012U	3/8"	1.10	.59	.63	.51	2.56
2014U	7/16"	1.10	.67	.63	.51	2.56
2016U	1/2"	1.10	.75	.63	.51	2.56
2018U	9/16"	1.10	.87	.63	.51	2.56
2020U	5/8"	1.10	.91	.63	.51	2.56
2022U	11/16"	1.26	1.02	.63	.51	2.56
2024U	3/4"	1.26	1.10	.63	.51	2.56
2026U	13/16"	1.26	1.18	.63	.51	2.56
2028U	7/8"	1.26	1.26	.63	.51	2.56
2030U	15/16"	1.26	1.34	.63	.51	2.56
2032U	1"	1.26	1.42	.63	.51	2.56
2034U	1-1/16"	1.26	1.50	.63	.51	2.56
2036U	1-1/8"	1.26	1.57	.71	.51	2.76
2038U	1-3/16"	1.26	1.65	.79	.51	2.83
2040U	1-1/4"	1.26	1.73	.79	.40	2.83

ANSI Specifications B107.2

6 Standard Length - Metric Sizes MM

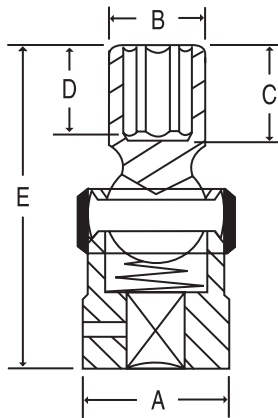

Item Number	Hex Size	Dimensions (Millimeters)				
		A	B	C	D	E
2010UM	10mm	28	15	16	13	65
2011UM	11mm	28	17	16	13	65
2012UM	12mm	28	19	16	13	65
2013UM	13mm	28	20	16	13	65
2014UM	14mm	28	22	16	13	65
2015UM	15mm	28	23	16	13	65
2016UM	16mm	28	23	16	13	65
2017UM	17mm	32	26	16	13	65
2018UM	18mm	32	26	16	13	65
2019UM	19mm	32	28	16	13	65
2020UM	20mm	32	30	16	13	65
2021UM	21mm	32	30	16	13	65
2022UM	22mm	32	32	16	13	65
2023UM	23mm	32	32	16	13	65
2024UM	24mm	32	34	16	13	65



1/2" Drive Deep Length Universal Impact Sockets



6 1/2" Drive - Deep Length Universal - Fractional Sizes SAE



Item Number	Hex Size	Dimensions (Inches)				
		A	B	C	D	E
2012UD	3/8"	1.10	.59	1.57	.55	3.54
2014UD	7/16"	1.10	.67	1.57	.79	3.54
2016UD	1/2"	1.10	.75	1.57	.79	3.54
2018UD	9/16"	1.10	.87	1.57	.79	3.54
2020UD	5/8"	1.10	.91	1.57	.79	3.54
2022UD	11/16"	1.26	1.02	1.57	.79	3.54
2024UD	3/4"	1.26	1.10	1.57	.98	3.54
2026UD	13/16"	1.26	1.18	1.57	.98	3.54
2028UD	7/8"	1.26	1.26	1.57	.98	3.54
2030UD	15/16"	1.26	1.34	1.57	.98	3.54
2032UD	1"	1.26	1.42	1.57	.98	3.54
2034UD	1-1/16"	1.26	1.50	1.57	.98	3.54
2036UD	1-1/8"	1.26	1.57	1.57	.98	3.54
2038UD	1-3/16"	1.26	1.65	1.57	.98	3.54
2040UD	1-1/4"	1.26	1.73	1.57	.98	3.54

ANSI Specifications B107.2

1/2"

6 Deep Length - Metric Sizes MM

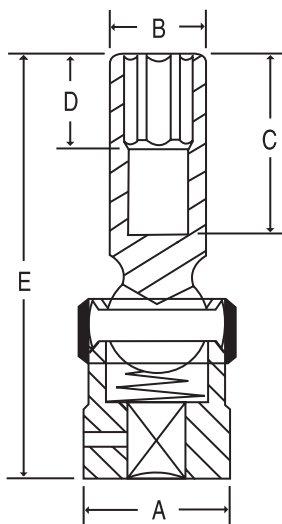

Item Number	Hex Size	Dimensions (Millimeters)				
		A	B	C	D	E
2010UMD	10mm	28	15	40	14	90
2011UMD	11mm	28	17	40	20	90
2012UMD	12mm	28	19	40	20	90
2013UMD	13mm	28	20	40	20	90
2014UMD	14mm	28	22	40	20	90
2015UMD	15mm	28	23	40	20	90
2016UMD	16mm	28	23	40	20	90
2017UMD	17mm	32	26	40	20	90
2018UMD	18mm	32	26	40	20	90
2019UMD	19mm	32	28	40	25	90
2020UMD	20mm	32	30	40	25	90
2021UMD	21mm	32	30	40	25	90
2022UMD	22mm	32	32	40	25	90
2023UMD	23mm	32	32	40	25	90
2024UMD	24mm	32	34	40	25	90



1/2" Drive 12-Point Standard Length Universal Impact Sockets



12 1/2" Drive 12-Point - Standard Length Universal - Fractional Sizes SAE



Item Number	12-Point Size	Dimensions (Inches)				
		A	B	C	D	E
2114U	7/16"	1.10	.67	.63	.51	2.56
2116U	1/2"	1.10	.75	.63	.51	2.56
2118U	9/16"	1.10	.83	.63	.51	2.56
2120U	5/8"	1.10	.91	.63	.51	2.56
2122U	11/16"	1.26	1.02	.63	.51	2.56
2124U	3/4"	1.26	1.10	.63	.51	2.56
2126U	13/16"	1.26	1.18	.63	.51	2.56
2128U	7/8"	1.26	1.26	.63	.51	2.56
2130U	15/16"	1.26	1.34	.63	.51	2.56
2132U	1"	1.26	1.42	.63	.51	2.56
2134U	1-1/16"	1.26	1.50	.63	.51	2.56
2136U	1-1/8"	1.26	1.57	.83	.71	2.76
2138U	1-3/16"	1.26	1.65	.91	.79	2.83
2140U	1-1/4"	1.26	1.73	.91	.79	2.83

ANSI Specifications B107.2

12 Standard Length - Metric Sizes MM

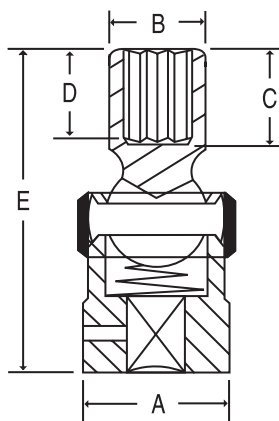

Item Number	12-Point Size	Dimensions (Millimeters)				
		A	B	C	D	E
2110UM	10mm	28	15	16	13	65
2111UM	11mm	28	17	16	13	65
2112UM	12mm	28	19	16	13	65
2113UM	13mm	28	20	16	13	65
2114UM	14mm	28	22	16	13	65
2115UM	15mm	28	23	16	13	65
2116UM	16mm	28	23	16	13	65
2117UM	17mm	32	26	16	13	65
2118UM	18mm	32	26	16	13	65
2119UM	19mm	32	28	16	13	65
2120UM	20mm	32	30	16	13	65
2121UM	21mm	32	30	16	13	65
2122UM	22mm	32	32	16	13	65
2123UM	23mm	32	32	16	13	65
2124UM	24mm	32	34	16	13	65



1/2" Drive Standard Length Magnetic Impact Sockets



1/2" Drive Magnetic - Standard Length - Fractional Sizes SAE



Item Number	Hex Size	Shape	Dimensions (Inches)			
			A	B	D	E
2012RG	3/8"	I	.99	.69	.16	1.50
2014RG	7/16"	I	.99	.75	.20	1.50
2016RG	1/2"	I	.99	.83	.20	1.50
2018RG	9/16"	I	.99	.91	.24	1.50
2020RG	5/8"	I	1.18	.98	.24	1.50
2022RG	11/16"	I	1.18	1.06	.24	1.50
2024RG	3/4"	I	1.18	1.14	.28	1.50
2026RG	13/16"	III	1.18	1.22	.31	1.50
2028RG	7/8"	III	1.18	1.30	.31	1.50
2030RG	15/16"	III	1.18	1.38	.39	1.77
2032RG	1"	III	1.18	1.46	.39	1.77

1/2"

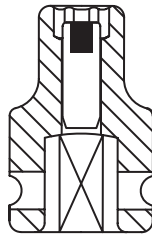

SHAPE I

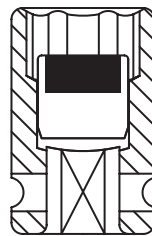

SHAPE II

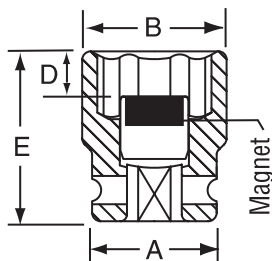

SHAPE III

Standard Length - Metric Sizes MM

Item Number	Hex Size	Shape	Dimensions (Millimeters)			
			A	B	D	E
2010MG	10mm	I	25	17.5	4	38
2011MG	11mm	I	25	18.7	5	38
2012MG	12mm	I	25	20.0	5	38
2013MG	13mm	I	25	21.0	5	38
2014MG	14mm	I	25	22.5	6	38
2015MG	15mm	I	30	23.7	6	38
2016MG	16mm	I	30	25.0	6	38
2017MG	17mm	I	30	26.5	6	38
2018MG	18mm	I	30	27.5	7	38
2019MG	19mm	I	30	29.0	7	38
2020MG	20mm	II	30	30.0	7	38
2021MG	21mm	III	30	31.0	8	38



1/2" Drive Deep Length Magnetic Impact Sockets



All deep magnetic sockets feature a spring loaded magnet that retracts into the socket for extended bolt applications.

1/2" Drive Magnetic - Deep Length - Fractional Sizes SAE

Magnetic



Item Number	Hex Size	Shape	Dimensions (Inches)				
			A	B	C	D	E
2012DG	3/8"	I	.98	.69	2.40	.20	3.07
2014DG	7/16"	I	.98	.75	2.40	.20	3.07
2016DG	1/2"	I	.98	.83	2.40	.24	3.07
2018DG	9/16"	I	.98	.91	2.40	.28	3.07
2020DG	5/8"	I	1.18	.98	2.40	.28	3.07
2022DG	11/16"	I	1.18	1.06	2.40	.28	3.07
2024DG	3/4"	I	1.18	1.14	2.40	.31	3.07
2026DG	13/16"	III	1.18	1.22	2.40	.35	3.07
2028DG	7/8"	III	1.18	1.30	2.40	.35	3.07
2030DG	15/16"	III	1.18	1.38	2.40	.43	3.07
2032DG	1"	III	1.18	1.46	2.40	.43	3.07

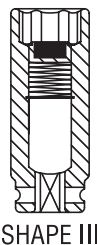
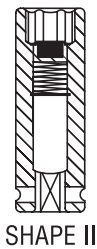
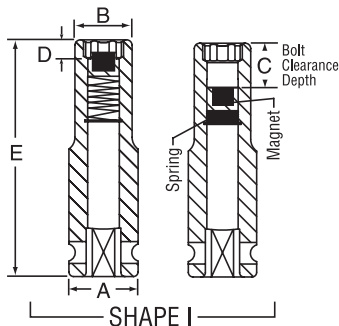

Deep Length - Metric Sizes MM

Item Number	Hex Size	Shape	Dimensions (Millimeters)				
			A	B	C	D	E
2010MDG	10mm	I	25	17.5	61	5	78
2011MDG	11mm	I	25	18.7	61	5	78
2012MDG	12mm	I	25	20.0	61	6	78
2013MDG	13mm	I	25	21.0	61	6	78
2014MDG	14mm	I	25	22.5	61	7	78
2015MDG	15mm	I	30	23.7	61	7	78
2016MDG	16mm	I	30	25.0	61	7	78
2017MDG	17mm	I	30	26.5	61	7	78
2018MDG	18mm	I	30	27.5	61	8	78
2019MDG	19mm	I	30	29.0	61	8	78
2020MDG	20mm	II	30	30.0	61	8	78
2021MDG	21mm	III	30	31.0	61	9	78



1/2" Drive Impact Attachments



1/2" Drive Adapters SAE

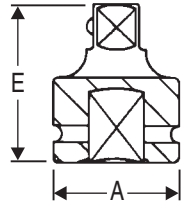

Item Number	Female End	Male End	Socket Retention Device	Dimensions (Inches)	
				A	E
*2228A	1/2"	3/8"	Friction Ball	.98	1.50
*2228AL	1/2"	3/8"	Locking Pin	.98	1.50
2238A	1/2"	3/4"	Friction Ball	1.18	1.89
2238AL	1/2"	3/4"	Locking Pin	1.18	1.89

1/2"

* Reducing Adapters are not covered by the GP Warranty.

* See page 182 for Reducing Sleeve Adapters

1/2" Drive Extra-Long Reducing Adapters SAE

Extra-long impact socket reducing adapters, forged in a single piece for extra strength and durability.



2257AL



2267AL



2277AL



Item Number	Overall Length	Female End	Male End	Socket Retention Device	Dimensions (Inches)	
					A	E
*2257AL	18"	1/2"	3/8"	Locking Pin	.98	18.11
*2267AL	24"	1/2"	3/8"	Locking Pin	.98	24.00
*2277AL	36"	1/2"	3/8"	Locking Pin	.98	36.00

* Reducing Adapters are not covered by the GP Warranty.

1/2" Drive Universal Joints SAE



2229UJ
(Standard)



2229TUJ
(Thin-Wall)



Item Number	Size	Socket Retention Device	Dimensions (Inches)		
			A	B	E
2229UJ	1/2" x 1/2"	Friction Ball	1.26	1.32	2.36
2229UJL	1/2" x 1/2"	Locking Pin	1.26	1.32	2.36
*2229TUJ	1/2" x 1/2"	Friction Ball	.93	1.00	2.36

* 2229TUJ is a thin-wall design that provides extra clearance in tight spaces.

Due to the thin wall design the #2229TUJ is not covered by the GP Warranty.



1/2" Drive Impact Attachments



No. 2204E 1/2" Drive Impact Extension Set SAE



4 piece set contents:

- 2243E 3" Extension
- 2245E 5" Extension
- 2247E 7" Extension
- 2210E 10" Extension
- Molded Storage Case

All items use the Friction Ball Retainer.



No. 2200 1/2" Drive Impact Adapter & Extension Set SAE



6 piece set contents:

- 2228A* 1/2" F. x 3/8" M. Adapter
- 2238A 1/2" F. x 3/4" M. Adapter
- 2229UJ 1/2" x 1/2" Universal Joint
- 2243E 3" Extension
- 2245E 5" Extension
- 2247E 7" Extension
- Molded Storage Case

All items use the Friction Ball Retainer.

*Reducing adapters are not covered by the GP Lifetime Warranty.





1/2" Drive Impact Attachments



1/2" Drive Extensions SAE



Standard

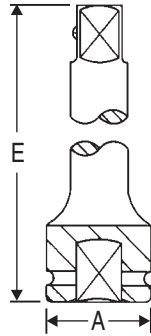

Item Number	Description	Socket Retention Device	Dimensions (Inches)	
			A	E
Standard Extensions				
2243E	3" Extension	Friction Ball	.98	2.95
*2243EH	3" H.D. Extension	Friction Ball	1.18	2.95
2243EL	3" Extension	Locking Pin	.98	2.95
2245E	5" Extension	Friction Ball	.98	4.92
*2245EH	5" H.D. Extension	Friction Ball	1.18	4.92
2245EL	5" Extension	Locking Pin	.98	4.92
2247E	7" Extension	Friction Ball	.98	6.89
2247EL	7" Extension	Locking Pin	.98	6.89
2210E	10" Extension	Friction Ball	.98	9.84
2210EL	10" Extension	Locking Pin	.98	9.84
2252E	12" Extension	Friction Ball	.98	11.81

Extra-Long Extensions

2259EL	18" Extension	Locking Pin	.98	18.11
2269EL	24" Extension	Locking Pin	.98	24.00
2279EL	36" Extension	Locking Pin	.98	36.00

*Heavy Duty Extensions for severe service applications.



Locking

Locking Extensions

These locking extensions feature a positive locking ball and sliding collar for quick release of sockets and accessories. Useful in hard to reach areas where a positive lock on the socket is required.

Item Number	Description	Dimensions (Inches)	
		A	E
2203QL	3 pc. Locking Extension Set - includes 3", 7", 12"		
2243QL	3" Locking Extension	.98	2.95
2247QL	7" Locking Extension	.98	6.89
2252QL	12" Locking Extension	.98	11.81
2259QL	18" Locking Extension	.98	18.11
2269QL	24" Locking Extension	.98	24.02
2279QL	36" Locking Extension	.98	35.43

Socket Retention Device Key for 1/2" Drive Adapters, Extensions & Universal Joints



Do NOT run the tool when the socket is OFF the fastener.



FB Friction Ball

A spring loaded steel ball that lines up with the socket retainer hole. Use caution when using this system because the socket is held in place only by spring pressure on the steel ball.

LP Locking Pin

Spring loaded pin, simply line up with socket retainer hole and press pin. To release socket, insert object through retainer hole and press pin.





3/4" Drive 6-Point Impact Socket Sets



6 No. 8029 3/4" Drive Standard Length Fractional Set SAE



29 piece set contents:

3024R 3/4"	3044R 1-3/8"	3064R 2"
3026R 13/16"	3046R 1-7/16"	3066R 2-1/16"
3028R 7/8"	3048R 1-1/2"	3068R 2-1/8"
3030R 15/16"	3050R 1-9/16"	3070R 2-3/16"
3032R 1"	3052R 1-5/8"	3072R 2-1/4"
3034R 1-1/16"	3054R 1-11/16"	3074R 2-5/16"
3036R 1-1/8"	3056R 1-3/4"	3076R 2-3/8"
3038R 1-3/16"	3058R 1-13/16"	3078R 2-7/16"
3040R 1-1/4"	3060R 1-7/8"	3080R 2-1/2"
3042R 1-5/16"	3062R 1-15/16"	Molded Storage Case

6 No. 8029D 3/4" Drive Deep Length Fractional Set SAE



29 piece set contents:

3024D 3/4"	3044D 1-3/8"	3064D 2"
3026D 13/16"	3046D 1-7/16"	3066D 2-1/16"
3028D 7/8"	3048D 1-1/2"	3068D 2-1/8"
3030D 15/16"	3050D 1-9/16"	3070D 2-3/16"
3032D 1"	3052D 1-5/8"	3072D 2-1/4"
3034D 1-1/16"	3054D 1-11/16"	3074D 2-5/16"
3036D 1-1/8"	3056D 1-3/4"	3076D 2-3/8"
3038D 1-3/16"	3058D 1-13/16"	3078D 2-7/16"
3040D 1-1/4"	3060D 1-7/8"	3080D 2-1/2"
3042D 1-5/16"	3062D 1-15/16"	Molded Storage Case

6 No. 8026M 3/4" Drive Standard Length Metric Set MM



26 piece set contents:

3019M 19mm	3028M 28mm	3038M 38mm
3020M 20mm	3029M 29mm	3040M 40mm
3021M 21mm	3030M 30mm	3041M 41mm
3022M 22mm	3031M 31mm	3042M 42mm
3023M 23mm	3032M 32mm	3043M 43mm
3024M 24mm	3033M 33mm	3044M 44mm
3025M 25mm	3034M 34mm	3046M 46mm
3026M 26mm	3035M 35mm	3050M 50mm
3027M 27mm	3036M 36mm	Molded Storage Case

6 No. 8026MD 3/4" Drive Deep Length Metric Set MM



26 piece set contents:

3019MD 19mm	3028MD 28mm	3038MD 38mm
3020MD 20mm	3029MD 29mm	3040MD 40mm
3021MD 21mm	3030MD 30mm	3041MD 41mm
3022MD 22mm	3031MD 31mm	3042MD 42mm
3023MD 23mm	3032MD 32mm	3043MD 43mm
3024MD 24mm	3033MD 33mm	3044MD 44mm
3025MD 25mm	3034MD 34mm	3046MD 46mm
3026MD 26mm	3035MD 35mm	3050MD 50mm
3027MD 27mm	3036MD 36mm	Metal Case



3/4" Drive 12-Point Impact Socket Sets



No. 8129

3/4" Drive 12-Point Standard Length Fractional Set



29 piece set contents:

3124R 3/4"	3144R 1-3/8"	3164R 2"
3126R 13/16"	3146R 1-7/16"	3166R 2-1/16"
3128R 7/8"	3148R 1-1/2"	3168R 2-1/8"
3130R 15/16"	3150R 1-9/16"	3170R 2-3/16"
3132R 1"	3152R 1-5/8"	3172R 2-1/4"
3134R 1-1/16"	3154R 1-11/16"	3174R 2-5/16"
3136R 1-1/8"	3156R 1-3/4"	3176R 2-3/8"
3138R 1-3/16"	3158R 1-13/16"	3178R 2-7/16"
3140R 1-1/4"	3160R 1-7/8"	3180R 2-1/2"
3142R 1-5/16"	3162R 1-15/16"	Metal Case



No. 8129D

3/4" Drive 12-Point Deep Length Fractional Set



29 piece set contents:

3124D 3/4"	3144D 1-3/8"	3164D 2"
3126D 13/16"	3146D 1-7/16"	3166D 2-1/16"
3128D 7/8"	3148D 1-1/2"	3168D 2-1/8"
3130D 15/16"	3150D 1-9/16"	3170D 2-3/16"
3132D 1"	3152D 1-5/8"	3172D 2-1/4"
3134D 1-1/16"	3154D 1-11/16"	3174D 2-5/16"
3136D 1-1/8"	3156D 1-3/4"	3176D 2-3/8"
3138D 1-3/16"	3158D 1-13/16"	3178D 2-7/16"
3140D 1-1/4"	3160D 1-7/8"	3180D 2-1/2"
3142D 1-5/16"	3162D 1-15/16"	Metal Case



No. 8126M

3/4" Drive 12-Point Standard Length Metric Set



26 piece set contents:

3119M 19mm	3128M 28mm	3138M 38mm
3120M 20mm	3129M 29mm	3140M 40mm
3121M 21mm	3130M 30mm	3141M 41mm
3122M 22mm	3131M 31mm	3142M 42mm
3123M 23mm	3132M 32mm	3143M 43mm
3124M 24mm	3133M 33mm	3144M 44mm
3125M 25mm	3134M 34mm	3146M 46mm
3126M 26mm	3135M 35mm	3150M 50mm
3127M 27mm	3136M 36mm	Metal Case



No. 8126MD

3/4" Drive 12-Point Deep Length Metric Set



26 piece set contents:

3119MD 19mm	3128MD 28mm	3138MD 38mm
3120MD 20mm	3129MD 29mm	3140MD 40mm
3121MD 21mm	3130MD 30mm	3141MD 41mm
3122MD 22mm	3131MD 31mm	3142MD 42mm
3123MD 23mm	3132MD 32mm	3143MD 43mm
3124MD 24mm	3133MD 33mm	3144MD 44mm
3125MD 25mm	3134MD 34mm	3146MD 46mm
3126MD 26mm	3135MD 35mm	3150MD 50mm
3127MD 27mm	3136MD 36mm	Metal Case



WARNING: Always wear safety goggles when using Impact Tools. Use only properly matched fractional or metric sizes.



3/4"



3/4" Drive Impact Socket Sets



6 No. 8034 3/4" Drive Standard Length Fractional Set SAE



8 piece set contents:

- | | |
|-------------------|---------------------|
| 3032R.....1" | 3044R.....1-3/8" |
| 3034R.....1-1/16" | 3046R.....1-7/16" |
| 3036R.....1-1/8" | 3048R.....1-1/2" |
| 3040R.....1-1/4" | Molded Storage Case |
| 3042R.....1-5/16" | |

6 No. 8034D 3/4" Drive Deep Length Fractional Set SAE



8 piece set contents:

- | | |
|-------------------|---------------------|
| 3032D.....1" | 3044D.....1-3/8" |
| 3034D.....1-1/16" | 3046D.....1-7/16" |
| 3036D.....1-1/8" | 3048D.....1-1/2" |
| 3040D.....1-1/4" | Molded Storage Case |
| 3042D.....1-5/16" | |

6 No. 8134M 3/4" Drive Standard Length Metric Set MM



8 piece set contents:

- | | |
|----------------|---------------------|
| 3026M.....26mm | 3035M.....35mm |
| 3027M.....27mm | 3036M.....36mm |
| 3029M.....29mm | 3038M.....38mm |
| 3030M.....30mm | Molded Storage Case |
| 3032M.....32mm | |

6 No. 8134MD 3/4" Drive Deep Length Metric Set MM



8 piece set contents:

- | | |
|-----------------|---------------------|
| 3026MD.....26mm | 3035MD.....35mm |
| 3027MD.....27mm | 3036MD.....36mm |
| 3029MD.....29mm | 3038MD.....38mm |
| 3030MD.....30mm | Molded Storage Case |
| 3032MD.....32mm | |



3/4" Drive Impact Socket Sets



6 No. 8038 3/4" Drive Standard Length Fractional Set SAE



14 piece set contents:

3024R	3/4"	3040R	1-1/4"
3026R	13/16"	3042R	1-5/16"
3028R	7/8"	3044R	1-3/8"
3030R	15/16"	3046R	1-7/16"
3032R	1"	3048R	1-1/2"
3034R	1-1/16"	3052R	1-5/8"
3036R	1-1/8"		Molded Storage Case
3038R	1-3/16"		

3/4"

6 No. 8038D 3/4" Drive Deep Length Fractional Set SAE



14 piece set contents:

3024D	3/4"	3040D	1-1/4"
3026D	13/16"	3042D	1-5/16"
3028D	7/8"	3044D	1-3/8"
3030D	15/16"	3046D	1-7/16"
3032D	1"	3048D	1-1/2"
3034D	1-1/16"	3052D	1-5/8"
3036D	1-1/8"		Molded Storage Case
3038D	1-3/16"		

12 No. 8313 3/4" Drive 12-Point Standard Length Fractional Set SAE



13 piece set contents:

3124R	3/4"	3140R	1-1/4"
3126R	13/16"	3144R	1-3/8"
3128R	7/8"	3148R	1-1/2"
3130R	15/16"	3152R	1-5/8"
3132R	1"	3156R	1-3/4"
3134R	1-1/16"	3160R	1-7/8"
3136R	1-1/8"		Molded Storage Case





3/4" Drive Impact Socket Sets



6 No. 8032 3/4" Drive Wheel Service Set SAE MM



A complete 3/4" drive set designed for servicing truck wheels.

11 piece set contents:

- 3024D 3/4" Deep
- 3026D 13/16" Deep
- 3028D 7/8" Deep
- 3032D 1" Deep
- 3034DT 1-1/16" T.W. Deep
- 3036DT 1-1/8" T.W. Deep
- 3038D 1-3/16" Deep
- 3040DT 1-1/4" T.W. Deep
- 3033MD 33mm Deep
- 3048DB... 1-1/2" Deep Budd
- 3313S..... 13/16" Square Metal Case

3/4"

6 No. 8370 3/4" Drive Truck Pinion Locknut Set SAE



A set of seven (7) extra-thin wall deep length impact sockets for removing/installing transmission and differential end yoke locknuts* on a wide variety of trucks. You no longer need to modify an impact socket, or purchase expensive, custom designed hand sockets to service these parts. Because of the extra-thin wall design, larger drive impact tools with reducing adapters should not be used with these impact sockets.

*Use caution and follow the manufacturer's recommendations when servicing these parts.



7 piece set contents:

- 3764D 2"
- 3768D 2-1/8"
- 3772D 2-1/4"
- 3776D 2-3/8"
- 3780D 2-1/2"
- 3784D 2-5/8"
- 3788D 2-3/4"
- Plastic Tray & Metal Case

6 3/4" Drive Deep Length Truck Pinion Locknut Impact Sockets SAE MM

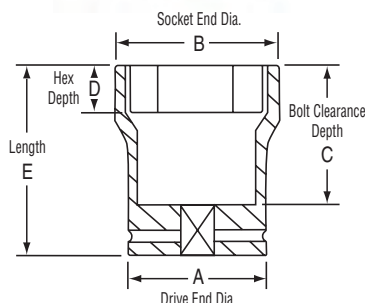

Item Number	Hex Size	Dimensions (Inches)				
		A	B	C	D	E
3764D	2"	2.36	2.65	3.00	1.02	4.10
3768D	2-1/8"	2.48	2.81	3.00	1.02	4.10
3772D	2-1/4"	2.60	2.99	3.00	1.02	4.10
3776D	2-3/8"	2.76	3.15	3.00	1.02	4.10
3780D	2-1/2"	2.87	3.27	3.00	1.02	4.10
3784D	2-5/8"	2.99	3.42	3.00	1.02	4.10
3788D	2-3/4"	3.07	3.60	3.00	1.02	4.10
3755M	55mm	2.52	2.85	3.00	1.02	4.10
3765M	65mm	2.91	3.33	3.00	1.02	4.10



3/4" Drive Standard Length Impact Sockets



6 3/4" Drive - Standard Length - Fractional Sizes SAE



ANSI Specifications B107.2



SHAPE I

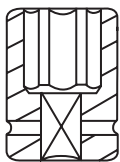

SHAPE II

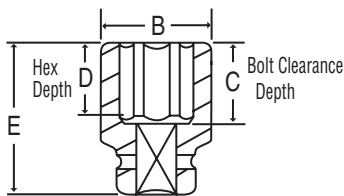

SHAPE III

Item Number	Hex Size	Shape	Retaining Devices			Dimensions (Inches)				
			P	O	R1	A	B	C	D	E
3016R	1/2"	I	3220	3210	3110	1.50	0.87	0.98	0.35	1.97
3018R	9/16"	I	3220	3210	3110	1.50	1.00	0.98	0.43	1.97
3020R	5/8"	I	3220	3210	3110	1.50	1.08	0.98	0.43	1.97
3022R	11/16"	I	3220	3210	3110	1.50	1.14	0.98	0.47	1.97
3024R	3/4"	I	3220	3210	3110	1.50	1.18	0.98	0.51	1.97
3026R	13/16"	I	3220	3210	3110	1.50	1.26	1.06	0.59	2.05
3028R	7/8"	I	3220	3210	3110	1.50	1.34	1.06	0.59	2.05
3030R	15/16"	I	3220	3210	3110	1.50	1.42	1.06	0.63	2.05
3032R	1"	III	3220	3210	3110	1.50	1.57	1.06	0.63	2.05
3034R	1-1/16"	III	3220	3210	3110	1.50	1.57	1.06	0.75	2.05
3036R	1-1/8"	III	3221	3211	3111	1.65	1.65	1.06	0.83	2.05
3038R	1-3/16"	III	3221	3212	3111	1.73	1.73	1.06	0.83	2.05
3040R	1-1/4"	III	3221	3212	3111	1.73	1.73	1.06	0.87	2.05
3042R	1-5/16"	III	3221	3212	3111	1.73	1.85	1.22	0.87	2.20
3044R	1-3/8"	III	3221	3212	3111	1.73	1.97	1.22	0.87	2.20
3046R	1-7/16"	III	3221	3212	3111	1.73	2.01	1.22	0.98	2.20
3048R	1-1/2"	III	3221	3212	3111	1.73	2.09	1.22	0.98	2.20
3050R	1-9/16"	III	3221	3212	3111	1.73	2.20	1.46	0.98	2.44
3052R	1-5/8"	III	3221	3212	3111	1.73	2.28	1.46	1.06	2.44
3054R	1-11/16"	III	3221	3212	3111	1.73	2.50	1.46	1.06	2.44
3056R	1-3/4"	III	3221	3212	3111	1.73	2.56	1.46	1.06	2.44
3058R	1-13/16"	III	3221	3212	3111	1.73	2.64	1.69	1.18	2.68
3060R	1-7/8"	III	3221	3212	3111	1.73	2.68	1.69	1.18	2.68
3062R	1-15/16"	III	3221	3212	3111	1.73	2.76	1.77	1.18	2.76
3064R	2"	III	4520	4511	3112	2.13	2.80	1.85	1.26	2.83
3066R	2-1/16"	III	4520	4511	3112	2.13	2.91	1.85	1.26	2.83
3068R	2-1/8"	III	4520	4511	3112	2.13	3.03	1.85	1.26	2.83
3070R	2-3/16"	III	4520	4511	3112	2.13	3.03	1.93	1.38	2.91
3072R	2-1/4"	III	4520	4511	3112	2.13	3.15	1.93	1.38	2.91
3074R	2-5/16"	III	4520	4511	3112	2.13	3.23	1.97	1.46	2.95
3076R	2-3/8"	III	4520	4511	3112	2.13	3.31	1.97	1.46	2.95
3078R	2-7/16"	III	4520	4511	3112	2.13	3.39	1.97	1.46	2.95
3080R	2-1/2"	III	4520	4511	3112	2.13	3.46	1.97	1.46	2.95
3082R	2-9/16"	III	4520	4511	3112	2.13	3.54	2.09	1.57	3.07
3084R	2-5/8"	III	4520	4511	3112	2.13	3.62	2.17	1.57	3.15
3086R	2-11/16"	III	4520	4511	3112	2.13	3.70	2.17	1.57	3.15
3088R	2-3/4"	III	4520	4511	3112	2.13	3.78	2.17	1.57	3.15
3090R	2-13/16"	III	4520	4511	3112	2.13	3.86	2.28	1.65	3.27
3092R	2-7/8"	III	4520	4511	3112	2.13	3.94	2.28	1.65	3.27
3094R	2-15/16"	III	4521	4512	-	2.52	4.02	2.28	1.65	3.27
3096R	3"	III	4521	4512	-	2.52	4.09	2.36	1.77	3.35

3/4"

Retaining Devices Key

P 	O 	R1
Pin and O-Ring		One Piece



3/4" Drive Standard Length Impact Sockets



6 3/4" Drive - Standard Length - Metric Sizes ▲ MM



ANSI Specifications B107.2

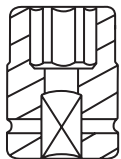

SHAPE I

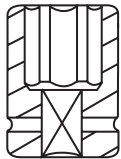

SHAPE II

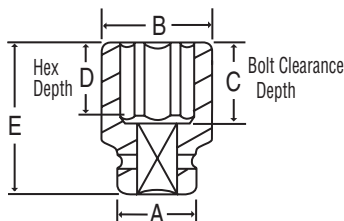

SHAPE III

Item Number	Hex Size	Shape	Retaining Devices			Dimensions (Millimeters)				
			P	O	R1	A	B	C	D	E
3019M	19mm	I	3220	3210	3110	38	30	25	13	50
3020M	20mm	I	3220	3210	3110	38	31	27	14	52
3021M	21mm	I	3220	3210	3110	38	32	27	15	52
3022M	22mm	I	3220	3210	3110	38	34	27	15	52
3023M	23mm	I	3220	3210	3110	38	35	27	16	52
3024M	24mm	I	3220	3210	3110	38	36	27	16	52
3025M	25mm	II	3220	3210	3110	38	38	27	16	52
3026M	26mm	III	3220	3210	3110	38	40	27	16	52
3027M	27mm	III	3220	3210	3110	38	40	27	19	52
3028M	28mm	II	3221	3211	3111	42	42	27	19	52
3029M	29mm	II	3221	3211	3111	42	42	27	21	52
3030M	30mm	II	3221	3212	3111	44	44	27	21	52
3031M	31mm	II	3221	3212	3111	44	44	27	21	52
3032M	32mm	II	3221	3212	3111	44	44	27	22	52
3033M	33mm	III	3221	3212	3111	44	47	31	22	52
3034M	34mm	III	3221	3212	3111	44	48	31	22	56
3035M	35mm	III	3221	3212	3111	44	50	31	22	56
3036M	36mm	III	3221	3212	3111	44	51	31	25	56
3038M	38mm	III	3221	3212	3111	44	53	31	25	56
3040M	40mm	III	3221	3212	3111	44	56	37	25	62
3041M	41mm	III	3221	3212	3111	44	58	37	27	62
3042M	42mm	III	3221	3212	3111	44	61	37	27	62
3043M	43mm	III	3221	3212	3111	44	63	38	27	63
3044M	44mm	III	3221	3212	3111	44	65	38	27	63
3046M	46mm	III	3221	3212	3111	44	67	38	30	63
3050M	50mm	III	4520	4511	3112	54	71	47	32	72

Retaining Devices Key



Pin and O-Ring

One Piece



3/4" Drive Deep Length Impact Sockets



6 3/4" Drive - Deep Length - Fractional Sizes SAE



ANSI Specifications B107.2

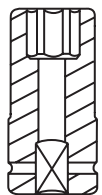

SHAPE I

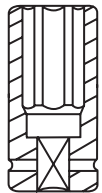

SHAPE II

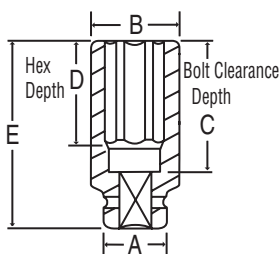

SHAPE III

Item Number	Hex Size	Shape	Retaining Devices			Dimensions (Inches)				
			P	O	R1	A	B	C	D	E
3016D	1/2"	I	3220	3210	3110	1.50	0.87	2.36	0.51	3.35
3018D	9/16"	I	3220	3210	3110	1.50	1.00	2.36	0.55	3.35
3020D	5/8"	I	3220	3210	3110	1.50	1.08	2.36	0.63	3.35
3022D	11/16"	I	3220	3210	3110	1.50	1.14	2.36	0.67	3.35
3024D	3/4"	I	3220	3210	3110	1.50	1.18	2.36	0.75	3.35
3026D	13/16"	I	3220	3210	3110	1.50	1.26	2.36	0.87	3.35
3028D	7/8"	I	3220	3210	3110	1.50	1.34	2.36	0.87	3.35
3030D	15/16"	I	3220	3210	3110	1.50	1.42	2.36	0.94	3.35
3032D	1"	III	3220	3210	3110	1.50	1.57	2.36	0.98	3.35
3034D	1-1/16"	III	3220	3210	3110	1.50	1.57	2.36	1.06	3.35
3036D	1-1/8"	II	3221	3211	3111	1.65	1.65	2.36	1.14	3.35
3038D	1-3/16"	II	3221	3212	3111	1.73	1.73	2.36	1.18	3.35
3040D	1-1/4"	III	3221	3212	3111	1.73	1.93	2.36	1.26	3.35
3042D	1-5/16"	III	3221	3212	3111	1.73	1.97	2.36	1.34	3.35
3044D	1-3/8"	III	3221	3212	3111	1.73	1.97	2.36	1.38	3.35
3046D	1-7/16"	III	3221	3212	3111	1.73	2.01	2.36	1.46	3.35
3048D	1-1/2"	III	3221	3212	3111	1.73	2.28	2.76	1.50	3.74
3050D	1-9/16"	III	3221	3212	3111	1.73	2.28	2.76	1.50	3.74
3052D	1-5/8"	III	3221	3212	3111	1.73	2.36	2.76	1.50	3.74
3054D	1-11/16"	III	3221	3212	3111	1.73	2.48	2.76	1.50	3.74
3056D	1-3/4"	III	3221	3212	3111	1.73	2.56	2.76	1.50	3.74
3058D	1-13/16"	III	3221	3212	3111	1.73	2.64	2.76	1.50	3.74
3060D	1-7/8"	III	3221	3212	3111	1.73	2.68	2.76	1.50	3.74
3062D	1-15/16"	III	3221	3212	3111	1.73	2.76	2.76	1.50	3.74
3064D	2"	III	4520	4511	3112	2.13	2.80	2.76	1.57	3.74
3066D	2-1/16"	III	4520	4511	3112	2.13	2.91	2.76	1.57	3.74
3068D	2-1/8"	III	4520	4511	3112	2.13	3.03	2.76	1.57	3.74
3070D	2-3/16"	III	4520	4511	3112	2.13	3.03	2.95	1.57	3.94
3072D	2-1/4"	III	4520	4511	3112	2.13	3.15	2.95	1.57	3.94
3074D	2-5/16"	III	4520	4511	3112	2.13	3.23	2.95	1.57	3.94
3076D	2-3/8"	III	4520	4511	3112	2.13	3.31	3.15	1.65	4.13
3078D	2-7/16"	III	4520	4511	3112	2.13	3.39	3.15	1.65	4.13
3080D	2-1/2"	III	4520	4511	3112	2.13	3.46	3.15	1.65	4.13
3082D	2-9/16"	III	4520	4511	3112	2.13	3.54	3.15	2.60	4.13
3084D	2-5/8"	III	4520	4511	3112	2.13	3.62	3.15	2.60	4.13
3086D	2-11/16"	III	4520	4511	3112	2.13	3.70	3.15	2.60	4.13
3088D	2-3/4"	III	4520	4511	3112	2.13	3.78	3.15	2.60	4.13
3090D	2-13/16"	III	4520	4511	3112	2.13	3.86	3.27	2.68	4.25
3092D	2-7/8"	III	4520	4511	3112	2.13	3.94	3.27	2.68	4.25
3094D	2-15/16"	III	4521	4512	-	2.52	4.02	3.27	2.68	4.25
3096D	3"	III	4521	4512	-	2.52	4.09	3.35	2.76	4.33

3/4"

Retaining Devices Key

P 	O 	R1
Pin and O-Ring		One Piece



3/4" Drive Deep Length Impact Sockets



6 3/4" Drive - Deep Length - Metric Sizes ▲ MM



ANSI Specifications B107.2

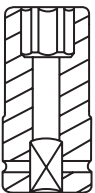

SHAPE I

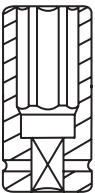

SHAPE II

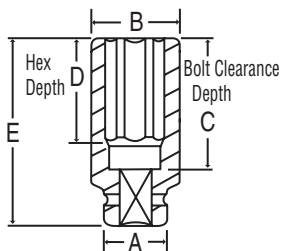

SHAPE III

Item Number	Hex Size	Shape	Retaining Devices			Dimensions (Millimeters)				
			P	O	R1	A	B	C	D	E
3019MD	19mm	I	3220	3210	3110	38	30	60	19	85
3020MD	20mm	I	3220	3210	3110	38	31	60	20	85
3021MD	21mm	I	3220	3210	3110	38	32	60	21	85
3022MD	22mm	I	3220	3210	3110	38	34	60	22	85
3023MD	23mm	I	3220	3210	3110	38	35	60	23	85
3024MD	24mm	I	3220	3210	3110	38	36	60	24	85
3025MD	25mm	II	3220	3210	3110	38	38	60	25	85
3026MD	26mm	III	3220	3210	3110	38	40	60	26	85
3027MD	27mm	III	3220	3210	3110	38	40	60	27	85
3028MD	28mm	II	3221	3211	3111	42	42	60	28	85
3029MD	29mm	II	3221	3211	3111	42	42	60	29	85
3030MD	30mm	II	3221	3212	3111	44	44	60	30	85
3031MD	31mm	II	3221	3212	3111	44	44	60	31	85
3032MD	32mm	III	3221	3212	3111	44	49	60	32	85
3033MD	33mm	III	3221	3212	3111	44	50	60	33	85
*3033MHD	33mm	III	3221	3212	3111	44	51	70	33	95
3034MD	34mm	III	3221	3212	3111	44	50	60	34	85
3035MD	35mm	III	3221	3212	3111	44	50	60	35	85
3036MD	36mm	III	3221	3212	3111	44	51	60	36	85
3038MD	38mm	III	3221	3212	3111	44	57	70	38	95
3040MD	40mm	III	3221	3212	3111	44	58	70	38	95
3041MD	41mm	III	3221	3212	3111	44	58	70	38	95
3042MD	42mm	III	3221	3212	3111	44	62	70	38	95
3043MD	43mm	III	3221	3212	3111	44	63	70	38	95
3044MD	44mm	III	3221	3212	3111	44	65	70	38	95
3046MD	46mm	III	3221	3212	3111	44	67	70	38	95
3050MD	50mm	III	4520	4511	3112	54	71	70	38	95

*Heavy Duty Impact Socket for Hub-Piloted Truck Wheel Fasteners

Retaining Devices Key



Pin and O-Ring

One Piece



3/4" Drive 12-Point Standard Length Impact Sockets



12

3/4" Drive 12-Point - Standard Length - Fractional Sizes SAE



Item Number	12-Point Size	Shape	Retaining Devices			Dimensions (Inches)				
			P	O	R1	A	B	C	D	E
3124R	3/4"	I	3221	3212	3111	1.73	1.30	0.98	0.51	1.97
3126R	13/16"	I	3221	3212	3111	1.73	1.38	0.98	0.59	1.97
3128R	7/8"	I	3221	3212	3111	1.73	1.46	0.98	0.59	1.97
3130R	15/16"	I	3221	3212	3111	1.73	1.54	0.98	0.71	1.97
3132R	1"	I	3221	3212	3111	1.73	1.61	0.98	0.71	1.97
3134R	1-1/16"	III	3221	3212	3111	1.73	1.69	1.14	0.75	2.13
3136R	1-1/8"	III	3221	3212	3111	1.73	1.75	1.14	0.83	2.13
3138R	1-3/16"	III	3221	3212	3111	1.73	1.85	1.14	0.83	2.13
3140R	1-1/4"	III	3221	3212	3111	1.73	1.93	1.22	0.87	2.20
3142R	1-5/16"	III	3221	3212	3111	1.73	2.01	1.22	0.87	2.20
3144R	1-3/8"	III	3221	3212	3111	1.73	2.09	1.22	0.87	2.20
3146R	1-7/16"	III	3221	3212	3111	1.73	2.17	1.22	0.98	2.20
3148R	1-1/2"	III	3221	3212	3111	1.73	2.24	1.30	0.98	2.28
3150R	1-9/16"	III	3221	3212	3111	1.73	2.32	1.30	0.98	2.28
3152R	1-5/8"	III	3221	3212	3111	1.73	2.40	1.30	1.06	2.28
3154R	1-11/16"	III	3221	3212	3111	1.73	2.50	1.50	1.06	2.48
3156R	1-3/4"	III	3221	3212	3111	1.73	2.54	1.50	1.06	2.48
3158R	1-13/16"	III	3221	3212	3111	1.73	2.64	1.50	1.18	2.48
3160R	1-7/8"	III	3221	3212	3111	1.73	2.68	1.69	1.18	2.68
3162R	1-15/16"	III	3221	3212	3111	1.73	2.76	1.77	1.18	2.76
3164R	2"	III	4520	4511	3112	2.13	2.83	1.85	1.26	2.83
3166R	2-1/16"	III	4520	4511	3112	2.13	2.91	1.85	1.26	2.83
3168R	2-1/8"	III	4520	4511	3112	2.13	3.03	1.85	1.26	2.83
3170R	2-3/16"	III	4520	4511	3112	2.13	3.09	1.93	1.38	2.91
3172R	2-1/4"	III	4520	4511	3112	2.13	3.15	1.93	1.38	2.91
3174R	2-5/16"	III	4520	4511	3112	2.13	3.23	1.97	1.46	2.95
3176R	2-3/8"	III	4520	4511	3112	2.13	3.31	1.97	1.46	2.95
3178R	2-7/16"	III	4520	4511	3112	2.13	3.39	1.97	1.46	2.95
3180R	2-1/2"	III	4520	4511	3112	2.13	3.46	1.97	1.46	2.95

3/4"

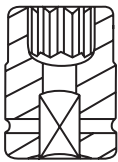

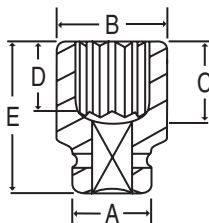

SHAPE I



SHAPE III

Retaining Devices Key

P 	O 	R1 
Pin and O-Ring		One Piece



3/4" Drive 12-Point Standard Length Impact Sockets



12 3/4" Drive 12-Point - Standard Length - Metric Sizes



Item Number	12-Point Size	Shape	Retaining Devices			Dimensions (Millimeters)				
			P	O	RI	A	B	C	D	E
3119M	19mm	I	3221	3212	3111	44	33.0	25	13	50
3120M	20mm	I	3221	3212	3111	44	34.0	25	14	50
3121M	21mm	I	3221	3212	3111	44	35.0	25	15	50
3122M	22mm	I	3221	3212	3111	44	37.0	25	15	50
3123M	23mm	I	3221	3212	3111	44	38.0	25	16	50
3124M	24mm	I	3221	3212	3111	44	39.0	25	18	50
3125M	25mm	I	3221	3212	3111	44	41.0	25	18	50
3126M	26mm	I	3221	3212	3111	44	42.0	25	18	50
3127M	27mm	I	3221	3212	3111	44	43.0	29	19	54
3128M	28mm	II	3221	3212	3111	44	44.0	29	19	54
3129M	29mm	III	3221	3212	3111	44	45.0	29	21	54
3130M	30mm	III	3221	3212	3111	44	47.0	29	21	54
3131M	31mm	III	3221	3212	3111	44	48.0	31	21	56
3132M	32mm	III	3221	3212	3111	44	49.0	31	22	56
3133M	33mm	III	3221	3212	3111	44	51.0	31	22	56
3134M	34mm	III	3221	3212	3111	44	52.0	31	22	56
3135M	35mm	III	3221	3212	3111	44	53.0	31	22	56
3136M	36mm	III	3221	3212	3111	44	54.0	31	25	56
3138M	38mm	III	3221	3212	3111	44	57.0	33	25	58
3140M	40mm	III	3221	3212	3111	44	59.0	33	25	58
3141M	41mm	III	3221	3212	3111	44	60.0	33	27	58
3142M	42mm	III	3221	3212	3111	44	62.0	33	27	58
3143M	43mm	III	3221	3212	3111	44	63.5	38	27	63
3144M	44mm	III	3221	3212	3111	44	64.5	38	27	63
3146M	46mm	III	3221	3212	3111	44	67.0	38	30	63
3150M	50mm	III	4520	4511	3112	54	71.0	47	32	72

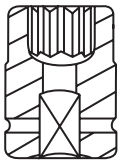

SHAPE I

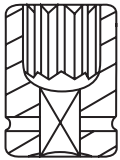

SHAPE II

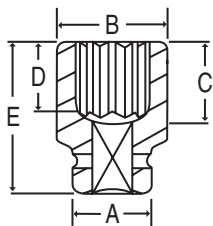

SHAPE III

Retaining Devices Key



Pin and O-Ring

One Piece



3/4" Drive 12-Point Deep Length Impact Sockets



3/4" Drive 12-Point - Deep Length - Fractional Sizes

SAE

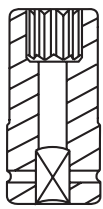

SHAPE I

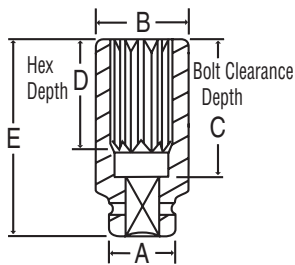



SHAPE III

Item Number	12-Point Size	Shape	Retaining Devices			Dimensions (Inches)				
			P	O	R1	A	B	C	D	E
3124D	3/4"	I	3221	3212	3111	1.73	1.30	2.76	0.75	3.74
3126D	13/16"	I	3221	3212	3111	1.73	1.38	2.76	0.87	3.74
3128D	7/8"	I	3221	3212	3111	1.73	1.46	2.76	0.87	3.74
3130D	15/16"	I	3221	3212	3111	1.73	1.54	2.76	0.94	3.74
3132D	1"	I	3221	3212	3111	1.73	1.61	2.76	0.98	3.74
3134D	1-1/16"	III	3221	3212	3111	1.73	1.69	2.76	1.06	3.74
3136D	1-1/8"	III	3221	3212	3111	1.73	1.75	2.76	1.14	3.74
3138D	1-3/16"	III	3221	3212	3111	1.73	1.85	2.76	1.18	3.74
3140D	1-1/4"	III	3221	3212	3111	1.73	1.93	2.76	1.26	3.74
3142D	1-5/16"	III	3221	3212	3111	1.73	2.01	2.76	1.34	3.74
3144D	1-3/8"	III	3221	3212	3111	1.73	2.09	2.76	1.38	3.74
3146D	1-7/16"	III	3221	3212	3111	1.73	2.17	2.76	1.46	3.74
3148D	1-1/2"	III	3221	3212	3111	1.73	2.24	2.76	1.50	3.74
3150D	1-9/16"	III	3221	3212	3111	1.73	2.32	2.76	1.50	3.74
3152D	1-5/8"	III	3221	3212	3111	1.73	2.40	2.76	1.50	3.74
3154D	1-11/16"	III	3221	3212	3111	1.73	2.50	2.76	1.50	3.74
3156D	1-3/4"	III	3221	3212	3111	1.73	2.54	2.76	1.50	3.74
3158D	1-13/16"	III	3221	3212	3111	1.73	2.64	2.95	1.50	3.94
3160D	1-7/8"	III	3221	3212	3111	1.73	2.68	2.95	1.50	3.94
3162D	1-15/16"	III	3221	3212	3111	1.73	2.76	2.95	1.50	3.94
3164D	2"	III	4520	4511	3112	2.13	2.83	2.95	1.57	3.94
3166D	2-1/16"	III	4520	4511	3112	2.13	2.91	2.95	1.57	3.94
3168D	2-1/8"	III	4520	4511	3112	2.13	3.03	2.95	1.57	3.94
3170D	2-3/16"	III	4520	4511	3112	2.13	3.09	3.15	1.57	4.13
3172D	2-1/4"	III	4520	4511	3112	2.13	3.15	3.15	1.57	4.13
3174D	2-5/16"	III	4520	4511	3112	2.13	3.23	3.15	1.57	4.13
3176D	2-3/8"	III	4520	4511	3112	2.13	3.31	3.15	1.65	4.13
3178D	2-7/16"	III	4520	4511	3112	2.13	3.39	3.15	1.65	4.13
3180D	2-1/2"	III	4520	4511	3112	2.13	3.46	3.15	1.65	4.13

3/4"

Retaining Devices Key

P 	O 	R1 
Pin and O-Ring		One Piece



3/4" Drive 12-Point Deep Length Impact Sockets



12 3/4" Drive 12-Point - Deep Length - Metric Sizes MM

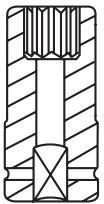

SHAPE I

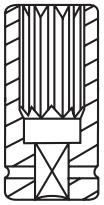

SHAPE II

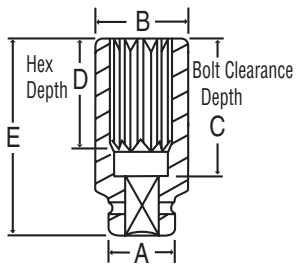

SHAPE III

Item Number	12-Point Size	Shape	Retaining Devices			Dimensions (Millimeters)				
			P	O	RI	A	B	C	D	E
3119MD	19mm	I	3221	3212	3111	44	33.0	70	19	95
3120MD	20mm	I	3221	3212	3111	44	34.0	70	20	95
3121MD	21mm	I	3221	3212	3111	44	35.0	70	21	95
3122MD	22mm	I	3221	3212	3111	44	37.0	70	22	95
3123MD	23mm	I	3221	3212	3111	44	38.0	70	23	95
3124MD	24mm	I	3221	3212	3111	44	39.0	70	24	95
3125MD	25mm	I	3221	3212	3111	44	41.0	70	25	95
3126MD	26mm	I	3221	3212	3111	44	42.0	70	26	95
3127MD	27mm	I	3221	3212	3111	44	43.0	70	27	95
3128MD	28mm	II	3221	3212	3111	44	44.0	70	28	95
3129MD	29mm	III	3221	3212	3111	44	45.0	70	29	95
3130MD	30mm	III	3221	3212	3111	44	47.0	70	30	95
3131MD	31mm	III	3221	3212	3111	44	48.0	70	31	95
3132MD	32mm	III	3221	3212	3111	44	49.0	70	32	95
3133MD	33mm	III	3221	3212	3111	44	51.0	70	33	95
3134MD	34mm	III	3221	3212	3111	44	52.0	70	34	95
3135MD	35mm	III	3221	3212	3111	44	53.0	70	35	95
3136MD	36mm	III	3221	3212	3111	44	54.0	70	36	95
3138MD	38mm	III	3221	3212	3111	44	57.0	70	38	95
3140MD	40mm	III	3221	3212	3111	44	59.0	70	38	95
3141MD	41mm	III	3221	3212	3111	44	60.0	70	38	95
3142MD	42mm	III	3221	3212	3111	44	62.0	70	38	95
3143MD	43mm	III	3221	3212	3111	44	63.5	70	38	95
3144MD	44mm	III	3221	3212	3111	44	64.5	70	38	95
3146MD	46mm	III	3221	3212	3111	44	67.0	75	38	100
3150MD	50mm	III	4520	4511	3112	54	71.0	75	38	100

Retaining Devices Key



Pin and O-Ring

One Piece



3/4" Drive Universal Impact Sockets



6 3/4" Drive - Universal - Fractional Sizes SAE



Item Number	Hex Size	Retaining Devices			Dimensions (Inches)				
		P	O	RI	A	B	C	D	E
3024U	3/4"	3221	3212	3111	1.73	1.26	0.79	0.51	3.74
3026U	13/16"	3221	3212	3111	1.73	1.38	0.79	0.55	3.74
3028U	7/8"	3221	3212	3111	1.73	1.46	0.79	0.55	3.74
3030U	15/16"	3221	3212	3111	1.73	1.54	0.79	0.59	3.74
3032U	1"	3221	3212	3111	1.73	1.61	0.91	0.63	3.94
3034U	1-1/16"	3221	3212	3111	1.73	1.69	0.91	0.67	3.94
3036U	1-1/8"	3221	3212	3111	1.73	1.73	0.91	0.71	3.94
3038U	1-3/16"	3221	3212	3111	1.73	1.85	0.91	0.71	3.94
3040U	1-1/4"	3221	3212	3111	1.73	1.93	1.06	0.79	4.13
3042U	1-5/16"	3221	3212	3111	1.73	2.01	1.06	0.83	4.13
3044U	1-3/8"	3221	3212	3111	1.73	2.09	1.06	0.87	4.13
3046U	1-7/16"	3221	3212	3111	1.73	2.13	1.14	0.91	4.33
3048U	1-1/2"	3221	3212	3111	1.73	2.24	1.14	0.94	4.33
3050U	1-9/16"	3221	3212	3111	1.73	2.36	1.14	0.94	4.33
3052U	1-5/8"	3221	3212	3111	1.73	2.36	1.38	1.06	4.53
3054U	1-11/16"	3221	3212	3111	1.73	2.50	1.38	1.06	4.53
3056U	1-3/4"	3221	3212	3111	1.73	2.54	1.38	1.18	4.53
3058U	1-13/16"	3221	3212	3111	1.73	2.62	1.38	1.18	4.53
3060U	1-7/8"	3221	3212	3111	1.73	2.68	1.38	1.18	4.53

3/4"

6 Universal - Metric Sizes MM

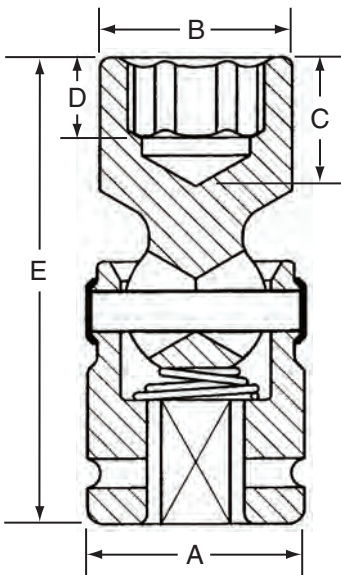

Item Number	Hex Size	Retaining Devices			Dimensions (Millimeters)				
		P	O	RI	A	B	C	D	E
3019UM	19mm	3221	3212	3111	44	32.0	20	13	95
3020UM	20mm	3221	3212	3111	44	34.0	20	14	95
3021UM	21mm	3221	3212	3111	44	35.0	20	14	95
3022UM	22mm	3221	3212	3111	44	37.0	20	14	95
3023UM	23mm	3221	3212	3111	44	38.0	20	14	95
3024UM	24mm	3221	3212	3111	44	39.0	20	15	95
3025UM	25mm	3221	3212	3111	44	41.0	23	16	100
3026UM	26mm	3221	3212	3111	44	42.0	23	16	100
3027UM	27mm	3221	3212	3111	44	43.0	23	17	100
3028UM	28mm	3221	3212	3111	44	44.0	23	18	100
3029UM	29mm	3221	3212	3111	44	46.0	23	18	100
3030UM	30mm	3221	3212	3111	44	47.0	23	18	100
3031UM	31mm	3221	3212	3111	44	48.0	27	19	105
3032UM	32mm	3221	3212	3111	44	49.0	27	20	105
3033UM	33mm	3221	3212	3111	44	51.0	27	21	105
3034UM	34mm	3221	3212	3111	44	52.0	27	22	105
3035UM	35mm	3221	3212	3111	44	53.0	27	22	105
3036UM	36mm	3221	3212	3111	44	54.0	29	23	110
3037UM	37mm	3221	3212	3111	44	56.0	29	24	110
3038UM	38mm	3221	3212	3111	44	57.0	29	24	110
3039UM	39mm	3221	3212	3111	44	59.0	29	24	110
3040UM	40mm	3221	3212	3111	44	60.0	29	24	110
3041UM	41mm	3221	3212	3111	44	60.0	35	27	115
3042UM	42mm	3221	3212	3111	44	62.0	35	27	115
3043UM	43mm	3221	3212	3111	44	63.5	35	27	115
3044UM	44mm	3221	3212	3111	44	64.5	35	30	115
3045UM	45mm	3221	3212	3111	44	66.0	35	30	115
3046UM	46mm	3221	3212	3111	44	66.5	35	30	115



3/4" Drive 8-Point Impact Sockets



8 3/4" Drive 8-Point - Standard Length - Fractional Sizes SAE



3/4"

Item Number	8-Point Size	Shape	Retaining Devices			Dimensions (Inches)				
			P	O	R1	A	B	C	D	E
3524S	3/4"	I	3220	3210	3110	1.57	1.57	0.98	0.51	1.97
3526S	13/16"	I	3221	3211	3111	1.65	1.65	0.98	0.59	1.97
3528S	7/8"	I	3221	3212	3111	1.73	1.73	0.98	0.59	1.97
3530S	15/16"	III	3221	3212	3111	1.75	1.81	1.06	0.71	2.05
3532S	1"	III	3221	3212	3111	1.75	1.97	1.06	0.71	2.05
3534S	1-1/16"	III	3221	3212	3111	1.75	2.09	1.14	0.75	2.13
3536S	1-1/8"	III	3221	3212	3111	1.75	2.20	1.14	0.75	2.13
3538S	1-3/16"	III	3221	3212	3111	1.75	2.28	1.14	0.83	2.13
3540S	1-1/4"	III	3221	3212	3111	1.75	2.40	1.22	0.87	2.20
3542S	1-5/16"	III	3221	3212	3111	1.75	2.50	1.22	0.87	2.20
3544S	1-3/8"	III	3221	3212	3111	1.75	2.60	1.22	0.87	2.20
3546S	1-7/16"	III	3221	3212	3111	1.75	2.68	1.22	0.94	2.20
3548S	1-1/2"	III	3221	3212	3111	1.75	2.76	1.30	0.94	2.28



SHAPE I

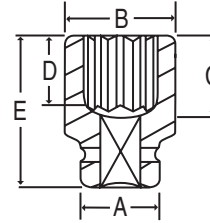

SHAPE III

8 3/4" Drive 8-Point - Deep Length - Fractional Sizes SAE



Item Number	8-Point Size	Shape	Retaining Devices			Dimensions (Inches)				
			P	O	R1	A	B	C	D	E
3524SD	3/4"	I	3220	3210	3110	1.57	1.57	2.76	0.51	3.74
3526SD	13/16"	I	3221	3211	3111	1.65	1.65	2.76	0.59	3.74
3528SD	7/8"	I	3221	3212	3111	1.73	1.73	2.76	0.59	3.74
3530SD	15/16"	III	3221	3212	3111	1.75	1.81	2.76	0.71	3.74
3532SD	1"	III	3221	3212	3111	1.75	1.97	2.76	0.71	3.74
3534SD	1-1/16"	III	3221	3212	3111	1.75	2.09	2.76	0.75	3.74
3536SD	1-1/8"	III	3221	3212	3111	1.75	2.20	2.76	0.75	3.74
3538SD	1-3/16"	III	3221	3212	3111	1.75	2.28	2.76	0.83	3.74
3540SD	1-1/4"	III	3221	3212	3111	1.75	2.40	2.76	0.87	3.74
3542SD	1-5/16"	III	3221	3212	3111	1.75	2.50	2.76	0.87	3.74
3544SD	1-3/8"	III	3221	3212	3111	1.75	2.60	2.76	0.87	3.74
3546SD	1-7/16"	III	3221	3212	3111	1.75	2.68	2.76	0.94	3.74
3548SD	1-1/2"	III	3221	3212	3111	1.75	2.76	2.76	0.94	3.74

Retaining Devices Key

P 	O 	R1
Pin and O-Ring		One Piece

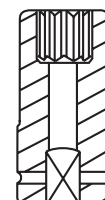

SHAPE I

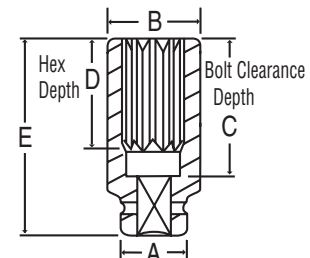

SHAPE III



3/4" Drive Special Application Impact Sockets



6 3/4" Drive Extra-Deep Thin Wall Sockets SAE MM

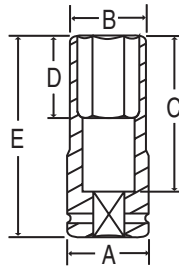

Designed for truck wheel service when removing lug nuts that are deeply recessed and where space is very limited.

Item Number	Hex Size	Dimensions (Inches/Millimeters)				
		A	B	C	D	E
3034DT	1-1/16"	1.69	1.57	3.27	1.69	4.25
3036DT	1-1/8"	1.69	1.65	3.27	1.69	4.25
3040DT	1-1/4"	1.77	1.77	3.27	1.69	4.25
3041MDT	41mm	45	54.5	83	43	108

6 3/4" Drive Budd Wheel Socket - 1-1/2" Limited Hex SAE

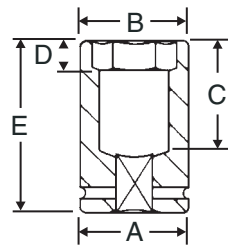

Special 1-1/2" hex deep heavy duty impact socket designed for outer cap nuts on budd-style truck wheels. The 1-1/2" hex depth is limited to help prevent socket contact with the wheel. The socket is deep style to eliminate contact with the inner cap nut.

Item Number	Hex Size	Dimensions (Inches)				
		A	B	C	D	E
3048DB	1-1/2"	2.24	2.24	2.83	.55	3.82

6 3/4" Drive Budd Wheel Socket - 1-1/2" Deep Hex SAE

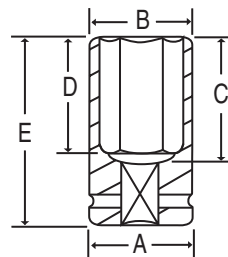

Special 1-1/2" hex deep heavy duty impact socket designed for outer cap nuts on budd-style truck wheels. The 1-1/2" hex depth is deep in length. The socket is a deep style to eliminate contact with the inner cap nut.

Item Number	Hex Size	Dimensions (Inches)				
		A	B	C	D	E
3048DS	1-1/2"	2.36	2.36	3.03	2.70	4.02

6 3/4" Drive Combination Budd Wheel Sockets SAE MM

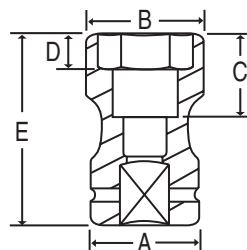

Removes and installs budd-type wheel fasteners. Sockets have two openings, eliminating the need for two separate sockets. Fractional and metric sizes.

Item Number	Hex Size	Square Size	Dimensions (Inches/Millimeters)				
			A	B	C	D	E
3223C	1-1/2"	13/16"	2.24	2.24	2.83	.55	3.82
3235MC	35mm	17mm	52	54	65	13	90
3241MC	41mm	21mm	54	58	83	14	97



3/4" Drive Special Application Impact Sockets



4 3/4" Drive 4-Point (Square) Standard Length Sockets SAE MM

Designed specifically for inner budd-style square fasteners on truck wheels. Fractional and metric sizes.

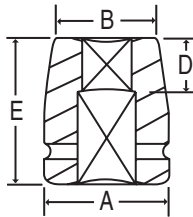

Item Number	Square Size	Dimensions (Inches/Millimeters)			
		A	B	D	E
3313S	13/16"	1.73	1.65	.94	2.44
3315S	15/16"	1.73	1.73	.94	2.44
3317S	17mm	44	40	24	62
3319S	19mm	40	40	24	52
3320S	20mm	44	42	24	62
3321S	21mm	44	42	24	62

4 3/4" Drive 4-Point (Square) Deep Length Socket SAE

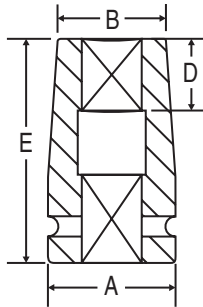

Designed for inner budd-style square fasteners on truck wheels where a deep style impact socket is desired.

Item Number	Square Size	Dimensions (Inches)			
		A	B	D	E
3313SL	13/16"	1.73	1.65	2.28	3.74

4 3/4" Drive 4-Point Heavy Duty (Square) Socket SAE

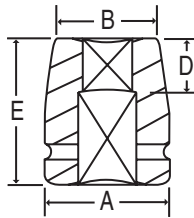

Designed specifically for inner budd-style square fasteners on truck wheels.

Item Number	Square Size	Dimensions (Inches)			
		A	B	D	E
3313SHD	13/16"	2.01	1.65	1.34	2.44

6 3/4" Drive 6-Point Extra-Long Sockets SAE MM

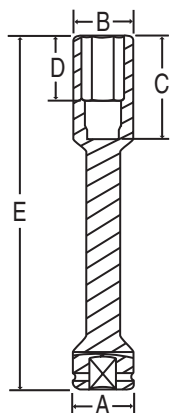

Extra-long impact sockets in popular sizes for use on truck wheels and other applications where a long reach is required. They reduce torque loss and eliminate the need for an extension on 3/4" drive impact tools with short anvils.

Item Number	Size	Dimensions (Inches/Millimeters)				
		A	B	C	D	E
3433MDL	33mm Hex	44	48	70	40	230
3434DL	1-1/16" Hex	1.73	1.65	2.76	1.57	9.06
3436DL	1-1/8" Hex	1.73	1.69	2.76	1.57	9.06
3440DL	1-1/4" Hex	1.73	1.85	2.76	1.57	9.06
3448DL	1-1/2" Hex	1.73	2.13	2.76	1.57	9.06
3713SL	13/16" Square	1.73	1.69	2.76	1.57	9.06



3/4" Drive Impact Attachments



3/4" Drive Adapters SAE

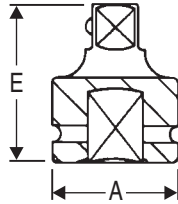

Item Number	Female End	Male End	Socket Retention Device	Dimensions (Inches)	
				A	E
*3008A	3/4"	1/2"	Friction Ball	1.73	2.28
*3008AL	3/4"	1/2"	Locking Pin	1.73	2.28
3009A	3/4"	1"	Pin Hole	1.73	2.48
3009AB	3/4"	1"	Friction Ball	1.73	2.48
3009AL	3/4"	1"	Locking Pin	1.73	2.48

Extra Long Adapter

3079AB	3/4"	1"	Friction Ball	1.73	6.89
---------------	-------------	-----------	---------------	------	------

* Reducing Adapters are not covered by the GP Warranty.

* See page 182 for Reducing Sleeve Adapters

3/4" Drive to #5 Spline Adapter SAE

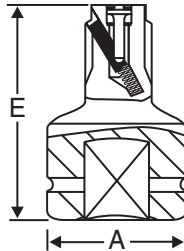

Item Number	Female End	Male End	Socket Retention Device	Dimensions (Inches)	
				A	E
3011A	3/4"	#5 Spline	Pin Hole	2.13	4.13
5500RK	Repair Kit for No. 3011A, No. 4011A, & No. 6011A				

3/4" Drive Universal Joint SAE

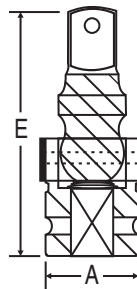

Item Number	Description	Dimensions (Inches)	
		A	E
3006UJ	3/4" x 3/4" w/Pin Hole	1.73	4.13

Socket Retention Device Key for 3/4" Drive Adapters, Extensions & Universal Joints



Do NOT run the tool when the socket is OFF the fastener.

PH Pin Hole

Uses Ret Ring® or Pin & O-ring to secure socket. The most secure system available. Recommended for 3/4" drive and larger impact wrenches.

FB Friction Ball

A spring loaded steel ball that lines up with the socket retainer hole. Use caution when using this system because the socket is held in place only by spring pressure on the steel ball.

LP Locking Pin

Spring loaded pin, simply line up with socket retainer hole and press pin. To release socket, insert object through retainer hole and press pin.



3/4" Drive Impact Attachments



No. 3304E 3/4" Drive Impact Extension Set SAE



4 piece set contents:

- 3003EB 3" Extension
- 3007EB 7" Extension
- 3010EB 10" Extension
- 3013EB 13" Extension
- Molded Storage Case

All items use the Friction Ball Retainer.



3/4"

3/4" Drive Extensions SAE



Item Number	Description	Socket Retention Device	Dimensions (Inches)	
			A	E
3003E	3" Extension	Pin Hole	1.73	2.95
3003EB	3" Extension	Friction Ball	1.73	2.95
3003EL	3" Extension	Locking Pin	1.73	2.95
3007E	7" Extension	Pin Hole	1.73	6.89
3007EB	7" Extension	Friction Ball	1.73	6.89
3007EL	7" Extension	Locking Pin	1.73	6.89
3010E	10" Extension	Pin Hole	1.73	9.84
3010EB	10" Extension	Friction Ball	1.73	9.84
3010EL	10" Extension	Locking Pin	1.73	9.84
3013E	13" Extension	Pin Hole	1.73	12.99
3013EB	13" Extension	Friction Ball	1.73	12.99
3013EL	13" Extension	Locking Pin	1.73	12.99

Socket Retention Device Key for 3/4" Drive Adapters, Extensions & Universal Joints



PH Pin Hole
Uses Ret Ring® or Pin & O-ring to secure socket. The most secure system available. Recommended for 3/4" drive and larger impact wrenches.

FB Friction Ball
A spring loaded steel ball that lines up with the socket retainer hole. Use caution when using this system because the socket is held in place only by spring pressure on the steel ball.

LP Locking Pin
Spring loaded pin, simply line up with socket retainer hole and press pin. To release socket, insert object through retainer hole and press pin.

Do NOT run the tool when the socket is OFF the fastener.



No. 30T20 3/4" Drive T-Handle Tool

This tool features a sliding drive head that allows for use in tight spaces. The head is held in place by a friction pin so it can slide flush with the ends of the bar. A Friction ball retainer holds sockets securely to the drive. When used as a breaker bar the 20" handle provides extra leverage.

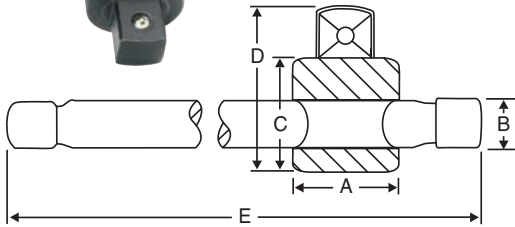

Item Number	Drive Size	Dimensions (Inches)				
		A	B	C	D	E
30T20	3/4"	1.58	.78	1.66	2.52	19.87

3/4"

3/4" Drive Socket O-Rings & Retaining Pins



PINS



Item Number	Fits Socket Drive End Diameters	Pin Diameter	Pin Length
3220	1.42" - 1.57" (36mm - 40mm)	.16" (4mm)	1.18" (30mm)
3221	1.65" - 1.75" (42mm - 44mm)	.16" (4mm)	1.38" (35mm)
4520	1.89" - 2.24" (48mm - 57mm)	.20" (5mm)	1.77" (45mm)

O-RINGS



Item Number	Fits Socket Drive End Diameters	O-Ring I.D.	O-Ring Thickness
3210	1.42" - 1.57" (36mm - 40mm)	1.22" (31mm)	.20" (5mm)
3211	1.65" - 1.69" (42mm - 43mm)	1.34" (34mm)	.20" (5mm)
3212	1.73" (44mm)	1.48" (37.5mm)	.20" (5mm)
4511	2.13" - 2.44" (54mm - 62mm)	1.85" (47mm)	.20" (5mm)

3/4" Ret Ring® One Piece Impact Socket Retainers



The Ret Ring® connects an impact socket onto an impact wrench, extension, adapter or universal joint. One-piece, molded of new space age polyurethane, with a steel insert for added safety. Available for 3/4", 1" and 1-1/2" drive impact sockets. 3/4" drive sizes listed below. For a complete listing and cross-reference to other manufacturer's part numbers see page 121.



Item Number	Square Drive Size	Fits Socket Ends "A" Diameters
3110	3/4"	1.50" (38mm)
3111	3/4"	1.65" - 1.77" (42mm - 44mm)
3112	3/4"	2.13" - 2.24" (54mm - 56mm)



Step 1
Place Ret Ring® over impact square drive, put on impact socket aligning retention holes, then insert center-pin through retention holes.



Step 2
Push center-pin completely through hole.



Step 3
Pull O-ring up into groove on opposite side.



1" Drive Standard Length Fractional Impact Socket Sets



6 No. 9021 1" Drive - Standard Length - Fractional Set SAE



21 piece set contents:

4024R.....	3/4"	4046R.....	1-7/16"
4026R.....	13/16"	4048R.....	1-1/2"
4028R.....	7/8"	4050R.....	1-9/16"
4030R.....	15/16"	4052R.....	1-5/8"
4032R.....	1"	4054R.....	1-11/16"
4034R.....	1-1/16"	4056R.....	1-3/4"
4036R.....	1-1/8"	4058R.....	1-13/16"
4038R.....	1-3/16"	4060R.....	1-7/8"
4040R.....	1-1/4"	4062R.....	1-15/16"
4042R.....	1-5/16"	4064R.....	2"
4044R.....	1-3/8"		Metal Case

6 No. 9016 1" Drive - Standard Length - Fractional Set SAE



16 piece set contents:

4066R.....	2-1/16"	4082R.....	2-9/16"
4068R.....	2-1/8"	4084R.....	2-5/8"
4070R.....	2-3/16"	4086R.....	2-11/16"
4072R.....	2-1/4"	4088R.....	2-3/4"
4074R.....	2-5/16"	4090R.....	2-13/16"
4076R.....	2-3/8"	4092R.....	2-7/8"
4078R.....	2-7/16"	4094R.....	2-15/16"
4080R.....	2-1/2"	4096R.....	3"
			Metal Case

6 No. 9011 1" Drive - Standard Length - Fractional Set SAE



11 piece set contents:

4100R.....	3-1/8"	4124R.....	3-7/8"
4104R.....	3-1/4"	4128R.....	4"
4108R.....	3-3/8"	4132R.....	4-1/8"
4112R.....	3-1/2"	4136R.....	4-1/4"
4116R.....	3-5/8"	4144R.....	4-1/2"
4120R.....	3-3/4"		Metal Case

Ordering the 3 sets above will provide complete coverage in 1" Drive Standard Length Fractional sizes.



1" Drive Deep Length Fractional Impact Socket Sets



6 No. 9021D 1" Drive - Deep Length - Fractional Set SAE



21 piece set contents:

4024D 3/4"	4046D 1-7/16"
4026D 13/16"	4048D 1-1/2"
4028D 7/8"	4050D 1-9/16"
4030D 15/16"	4052D 1-5/8"
4032D 1"	4054D 1-11/16"
4034D 1-1/16"	4056D 1-3/4"
4036D 1-1/8"	4058D 1-13/16"
4038D 1-3/16"	4060D 1-7/8"
4040D 1-1/4"	4062D 1-15/16"
4042D 1-5/16"	4064D 2"
4044D 1-3/8"		Metal Case

6 No. 9016D 1" Drive - Deep Length - Fractional Set SAE



16 piece set contents:

4066D 2-1/16"	4082D 2-9/16"
4068D 2-1/8"	4084D 2-5/8"
4070D 2-3/16"	4086D 2-11/16"
4072D 2-1/4"	4088D 2-3/4"
4074D 2-5/16"	4090D 2-13/16"
4076D 2-3/8"	4092D 2-7/8"
4078D 2-7/16"	4094D 2-15/16"
4080D 2-1/2"	4096D 3"
			Metal Case

6 No. 9011D 1" Drive - Deep Length - Fractional Set SAE



11 piece set contents:

4100D 3-1/8"	4124D 3-7/8"
4104D 3-1/4"	4128D 4"
4108D 3-3/8"	4132D 4-1/8"
4112D 3-1/2"	4136D 4-1/4"
4116D 3-5/8"	4144D 4-1/2"
4120D 3-3/4"		Metal Case

Ordering the 3 sets above will provide complete coverage in 1" Drive Deep Length Fractional sizes.



1" Drive Standard Length Metric Impact Socket Sets



6 No. 9026M 1" Drive - Standard Length - Metric Set



26 piece set contents:

4019M.	19mm	4032M.	32mm
4020M.	20mm	4033M.	33mm
4021M.	21mm	4034M.	34mm
4022M.	22mm	4035M.	35mm
4023M.	23mm	4036M.	36mm
4024M.	24mm	4037M.	37mm
4025M.	25mm	4038M.	38mm
4026M.	26mm	4039M.	39mm
4027M.	27mm	4040M.	40mm
4028M.	28mm	4041M.	41mm
4029M.	29mm	4042M.	42mm
4030M.	30mm	4043M.	43mm
4031M.	31mm	4044M.	44mm
			Metal Case

1"

6 No. 9020M 1" Drive - Standard Length - Metric Set



20 piece set contents:

4045M.	45mm	4056M.	56mm
4046M.	46mm	4057M.	57mm
4047M.	47mm	4058M.	58mm
4048M.	48mm	4060M.	60mm
4050M.	50mm	4062M.	62mm
4051M.	51mm	4063M.	63mm
4052M.	52mm	4065M.	65mm
4053M.	53mm	4067M.	67mm
4054M.	54mm	4070M.	70mm
4055M.	55mm	4075M.	75mm
			Metal Case

6 No. 9011M 1" Drive - Standard Length - Metric Set



11 piece set contents:

4076M.	76mm	4095M.	95mm
4077M.	77mm	40100M.	100mm
4078M.	78mm	40105M.	105mm
4080M.	80mm	40110M.	110mm
4085M.	85mm	40115M.	115mm
4090M.	90mm		Metal Case

Ordering the 3 sets above will provide complete coverage in 1" Drive Standard Length Metric sizes.



1" Drive Deep Length Metric Impact Socket Sets



6 No. 9026MD 1" Drive - Deep Length - Metric Set ▲ MM



26 piece set contents:

4019MD	19mm	4032MD32mm
4020MD20mm	4033MD33mm
4021MD21mm	4034MD34mm
4022MD22mm	4035MD35mm
4023MD23mm	4036MD36mm
4024MD24mm	4037MD37mm
4025MD25mm	4038MD38mm
4026MD26mm	4039MD39mm
4027MD27mm	4040MD40mm
4028MD28mm	4041MD41mm
4029MD29mm	4042MD42mm
4030MD30mm	4043MD43mm
4031MD31mm	4044MD44mm

Metal Case

6 No. 9020MD 1" Drive - Deep Length - Metric Set ▲ MM



20 piece set contents:

4045MD45mm	4056MD56mm
4046MD46mm	4057MD57mm
4047MD47mm	4058MD58mm
4048MD48mm	4060MD60mm
4050MD50mm	4062MD62mm
4051MD51mm	4063MD63mm
4052MD52mm	4065MD65mm
4053MD53mm	4067MD67mm
4054MD54mm	4070MD70mm
4055MD55mm	4075MD75mm

Metal Case

6 No. 9011MD 1" Drive - Deep Length - Metric Set ▲ MM



11 piece set contents:

4076MD76mm	4095MD95mm
4077MD77mm	40100MD100mm
4078MD78mm	40105MD105mm
4080MD80mm	40110MD110mm
4085MD85mm	40115MD115mm
4090MD90mm			Metal Case

Ordering the 3 sets above will provide complete coverage in 1" Drive Deep Length Metric sizes.



1" Drive 12-Point Standard Length Fractional Impact Socket Sets



12 No. 9121 1" Drive 12-Point - Standard Length - Fractional Set SAE



21 piece set contents:

4224R 3/4"	4246R 1-7/16"
4226R 13/16"	4248R 1-1/2"
4228R 7/8"	4250R 1-9/16"
4230R 15/16"	4252R 1-5/8"
4232R 1"	4254R 1-11/16"
4234R 1-1/16"	4256R 1-3/4"
4236R 1-1/8"	4258R 1-13/16"
4238R 1-3/16"	4260R 1-7/8"
4240R 1-1/4"	4262R 1-15/16"
4242R 1-5/16"	4264R 2"
4244R 1-3/8"		

Metal Case

12 No. 9116 1" Drive 12-Point - Standard Length - Fractional Set SAE



16 piece set contents:

4266R 2-1/16"	4282R 2-9/16"
4268R 2-1/8"	4284R 2-5/8"
4270R 2-3/16"	4286R 2-11/16"
4272R 2-1/4"	4288R 2-3/4"
4274R 2-5/16"	4290R 2-13/16"
4276R 2-3/8"	4292R 2-7/8"
4278R 2-7/16"	4294R 2-15/16"
4280R 2-1/2"	4296R 3"

Metal Case

12 No. 9111 1" Drive 12-Point - Standard Length - Fractional Set SAE



11 piece set contents:

4300R 3-1/8"	4324R 3-7/8"
4304R 3-1/4"	4328R 4"
4308R 3-3/8"	4332R 4-1/8"
4312R 3-1/2"	4336R 4-1/4"
4316R 3-5/8"	4344R 4-1/2"
4320R 3-3/4"		

Metal Case

Ordering the 3 sets above will provide complete coverage in 1" Drive 12-Point Standard Length Fractional sizes.



1" Drive 12-Point Deep Length Fractional Impact Socket Sets



12 No. 9121D 1" Drive 12-Point - Deep Length - Fractional Set SAE



21 piece set contents:

4224D 3/4"	4246D 1-7/16"
4226D 13/16"	4248D 1-1/2"
4228D 7/8"	4250D 1-9/16"
4230D 15/16"	4252D 1-5/8"
4232D 1"	4254D 1-11/16"
4234D 1-1/16"	4256D 1-3/4"
4236D 1-1/8"	4258D 1-13/16"
4238D 1-3/16"	4260D 1-7/8"
4240D 1-1/4"	4262D 1-15/16"
4242D 1-5/16"	4264D 2"
4244D 1-3/8"		Metal Case

12 No. 9116D 1" Drive 12-Point - Deep Length - Fractional Set SAE



16 piece set contents:

4266D 2-1/16"	4282D 2-9/16"
4268D 2-1/8"	4284D 2-5/8"
4270D 2-3/16"	4286D 2-11/16"
4272D 2-1/4"	4288D 2-3/4"
4274D 2-5/16"	4290D 2-13/16"
4276D 2-3/8"	4292D 2-7/8"
4278D 2-7/16"	4294D 2-15/16"
4280D 2-1/2"	4296D 3"
			Metal Case

12 No. 9111D 1" Drive 12-Point - Deep Length - Fractional Set SAE



11 piece set contents:

4300D 3-1/8"	4324D 3-7/8"
4304D 3-1/4"	4328D 4"
4308D 3-3/8"	4332D 4-1/8"
4312D 3-1/2"	4336D 4-1/4"
4316D 3-5/8"	4344D 4-1/2"
4320D 3-3/4"		Metal Case

Ordering the 3 sets above will provide complete coverage in 1" Drive 12-Point Deep Length Fractional sizes.



1" Drive 12-Point Standard Length Metric Impact Socket Sets



12 No. 9126M 1" Drive 12-Point - Standard Length - Metric Set



26 piece set contents:

4119M.	19mm	4132M.	32mm
4120M.	20mm	4133M.	33mm
4121M.	21mm	4134M.	34mm
4122M.	22mm	4135M.	35mm
4123M.	23mm	4136M.	36mm
4124M.	24mm	4137M.	37mm
4125M.	25mm	4138M.	38mm
4126M.	26mm	4139M.	39mm
4127M.	27mm	4140M.	40mm
4128M.	28mm	4141M.	41mm
4129M.	29mm	4142M.	42mm
4130M.	30mm	4143M.	43mm
4131M.	31mm	4144M.	44mm

Metal Case

12 No. 9120M 1" Drive 12-Point - Standard Length - Metric Set



20 piece set contents:

4145M.	45mm	4156M.	56mm
4146M.	46mm	4157M.	57mm
4147M.	47mm	4158M.	58mm
4148M.	48mm	4160M.	60mm
4150M.	50mm	4162M.	62mm
4151M.	51mm	4163M.	63mm
4152M.	52mm	4165M.	65mm
4153M.	53mm	4167M.	67mm
4154M.	54mm	4170M.	70mm
4155M.	55mm	4175M.	75mm

Metal Case

12 No. 9111M 1" Drive 12-Point - Standard Length - Metric Set



11 piece set contents:

4176M.	76mm	4195M.	95mm
4177M.	77mm	41100M.	100mm
4178M.	78mm	41105M.	105mm
4180M.	80mm	41110M.	110mm
4185M.	85mm	41115M.	115mm
4190M.	90mm		Metal Case

Ordering the 3 sets above will provide complete coverage in 1" Drive 12-Point Standard Length Metric sizes.



1" Drive 12-Point Deep Length Metric Impact Socket Sets



12 No. 9126MD 1" Drive 12-Point - Deep Length - Metric Set MM



26 piece set contents:

4119MD19mm	4132MD32mm
4120MD20mm	4133MD33mm
4121MD21mm	4134MD34mm
4122MD22mm	4135MD35mm
4123MD23mm	4136MD36mm
4124MD24mm	4137MD37mm
4125MD25mm	4138MD38mm
4126MD26mm	4139MD39mm
4127MD27mm	4140MD40mm
4128MD28mm	4141MD41mm
4129MD29mm	4142MD42mm
4130MD30mm	4143MD43mm
4131MD31mm	4144MD44mm

Metal Case

12 No. 9120MD 1" Drive 12-Point - Deep Length - Metric Set MM



20 piece set contents:

4145MD45mm	4156MD56mm
4146MD46mm	4157MD57mm
4147MD47mm	4158MD58mm
4148MD48mm	4160MD60mm
4150MD50mm	4162MD62mm
4151MD51mm	4163MD63mm
4152MD52mm	4165MD65mm
4153MD53mm	4167MD67mm
4154MD54mm	4170MD70mm
4155MD55mm	4175MD75mm

Metal Case

12 No. 9111MD 1" Drive 12-Point - Deep Length - Metric Set MM



11 piece set contents:

4176MD76mm	4195MD95mm
4177MD77mm	41100MD100mm
4178MD78mm	41105MD105mm
4180MD80mm	41110MD110mm
4185MD85mm	41115MD115mm
4190MD90mm			

Metal Case

Ordering the 3 sets above will provide complete coverage in 1" Drive 12-Point Deep Length Metric sizes.



1" Drive Impact Socket Sets



6 No. 9108 1" Drive Standard Length Fractional Set SAE



8 piece set contents:

4028R 7/8"	4038R 1-3/16"
4030R 15/16"	4040R 1-1/4"
4032R 1"	4048R 1-1/2"
4034R 1-1/16"	Molded Storage Case
4036R 1-1/8"	

6 No. 9108D 1" Drive Deep Length Fractional Set SAE



8 piece set contents:

4028D 7/8"	4038D 1-3/16"
4030D 15/16"	4040D 1-1/4"
4032D 1"	4048D 1-1/2"
4034D 1-1/16"	Molded Storage Case
4036D 1-1/8"	

6 No. 9109D 1" Drive Deep Length Metric Set MM



8 piece set contents:

4027MD27mm	4036MD36mm
4030MD30mm	4038MD38mm
4032MD32mm	4041MD41mm
4033MD33mm	Metal Storage Case
4035MD35mm	

6 No. 9159 1" Drive Jumbo Fractional Set SAE



9 piece set contents:

4032R 1"	4052R 1-5/8"
4036R 1-1/8"	4056R 1-3/4"
4040R 1-1/4"	4060R 1-7/8"
4044R 1-3/8"	4064R 2"
4048R 1-1/2"	Metal Storage Case



1" Drive Impact Socket Sets for Wheel Service



6 No. 9007

1" Drive Wheel Service Set SAE MM



Seven (7) of our most popular impact sockets used on truck wheel fasteners. They are individually displayed in a tough blue molded case for easy carrying and storage.

7 piece set contents:

- | | |
|-------------------------------------|------------------------------------|
| 4313S 13/16" Square | 4040DT 1-1/4" T.W. Deep |
| 4038R 1-3/16" (30mm) Std. | 4033MD 33mm Deep |
| 4034DT 1-1/16" T.W. Deep | 4048D 1-1/2" (38mm) Deep |
| 4036DT 1-1/8" T.W. Deep | Molded Storage Case |

6 No. 9151

1" Drive Heavy Duty Wheel Service Set SAE MM



A 1" drive deep set designed for servicing medium and heavy duty truck wheels.

10 piece set contents:

- | | |
|------------------------------------|-----------------------------------|
| 4313S 13/16" Square | 4038D 1-3/16" Deep |
| 4315S 15/16" Square | 4040DT 1-1/4" T.W. Deep |
| 4032D 1" Deep | 4048D 1-1/2" Deep |
| 4033MD 33mm Deep | 4056D 1-3/4" Deep |
| 4034DT 1-1/16" T.W. Deep | Metal Storage Case |
| 4036DT 1-1/8" T.W. Deep | |

6 No. 9152

1" Drive Wheel Service Set SAE MM



A complete 1" drive set designed for servicing truck wheels. It contains a 13/16" square size for budd wheel inner cap nuts, a 1-1/2" outer budd nut size that has a "controlled depth" hex end to help prevent contact with the wheel, a 33mm size for 10 hole hub piloted wheels, three (3) deep thin wall sizes, and other regular length impact sockets.

10 piece set contents:

- | | |
|----------------------------------|------------------------------------|
| 4313S 13/16" Square | 4034DT 1-1/16" T.W. Deep |
| 4028R 7/8" Standard | 4036DT 1-1/8" T.W. Deep |
| 4030R 15/16" Standard | 4040DT 1-1/4" T.W. Deep |
| 4032R 1" Standard | 4048DB 1-1/2" Deep Budd |
| 4038R 1-3/16" Standard | Molded Storage Case |
| 4033MD 33mm Deep | |

6 No. 9153

1" Drive Wheel Service Set SAE MM



Ten (10) of the most popular fractional and metric impact socket sizes for truck wheel fasteners.

10 piece set contents:

- | | |
|------------------------------------|-----------------------------------|
| 4313S 13/16" Square | 4048DB 1-1/2" Deep Budd |
| 4317S 17mm Square | 4033MD 33mm Deep |
| 4321S 21mm Square | 4035MD 35mm Deep |
| 4034DT 1-1/16" T.W. Deep | 4041MD 41mm Deep |
| 4036DT 1-1/8" T.W. Deep | Molded Storage Case |
| 4040DT 1-1/4" T.W. Deep | |



1" Drive Impact Socket Sets for Wheel Service



6 No. 9154 1" Drive Wheel Service Set SAE MM

This set includes eight (8) popular impact socket sizes for truck wheel fasteners.



8 piece set contents:

- | | |
|-----------------------------|---------------------------|
| 4313S 13/16" Square | 4036DT . 1-1/8" T.W. Deep |
| 4028R 7/8" Standard | 4040DT . 1-1/4" T.W. Deep |
| 4032R 1" Standard | 4048D 1-1/2" Deep |
| 4033M . . . 33mm Standard | Molded Storage Case |
| 4034DT . 1-1/16" T.W. Deep | |

6 No. 9155 1" Drive Metric Wheel Service Set MM

This set includes seven (7) of the most popular metric impact socket sizes for metric truck wheel fasteners.



7 piece set contents:

- | | |
|---------------------------|--------------------------|
| 4317S 17mm Square | 4035MD 35mm Deep |
| 4321S 21mm Square | 4038MD 38mm Deep |
| 4030MD 30mm Deep | 4041MD 41mm Deep |
| 4033MD 33mm Deep | Metal Storage Case |

6 No. 9157 1" Drive Metric Wheel Service Set MM

An eleven (11) piece metric impact socket set for servicing tires and wheels on a complete range of imported trucks with metric wheel fasteners.



11 piece set contents:

- | | |
|---------------------------|---------------------------|
| 4317S 17mm Square | 4033M . . . 33mm Standard |
| 4320S 20mm Square | 4035MD 35mm Deep |
| 4321S 21mm Square | 4036MD 36mm Deep |
| 4027M . . . 27mm Standard | 4038MD 38mm Deep |
| 4030M . . . 30mm Standard | 4041MD 41mm Deep |
| 4032M . . . 32mm Standard | Metal Storage Case |

6 No. 9161D 1" Drive Large Truck Wheel / OTR Wheel Service Set SAE MM

This set contains impact sockets designed to fit large truck and off-the-road wheel fasteners.



9 piece set contents:

- | | |
|-----------------------------|---------------------------|
| 4313S 13/16" Square | 4056D 1-3/4" Deep |
| 4315S 15/16" Square | 4060D 1-7/8" Deep |
| 4033MD 33mm Deep | 4064D 2" Deep |
| 4048D 1-1/2" Deep | 4072D 2-1/4" Deep |
| 4052D 1-5/8" Deep | Metal Storage Case |



1" Drive Standard Length Impact Sockets



6 1" Drive - Standard Length - Fractional Sizes SAE



ANSI Specifications B107.2



SHAPE I

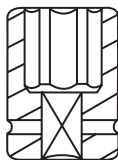

SHAPE II

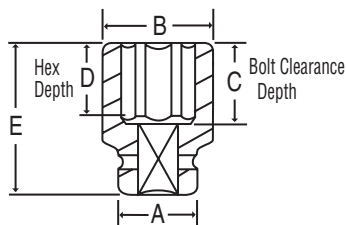

SHAPE III

Item Number	Hex Size	Shape	*Retaining Devices			Dimensions (Inches)				
			P	O	R1	A	B	C	D	E
4024R	3/4"	I	4520	4510	4110	2.01	1.42	1.10	0.51	2.28
4026R	13/16"	I	4520	4510	4110	2.01	1.50	1.10	0.59	2.28
4028R	7/8"	I	4520	4510	4110	2.01	1.54	1.10	0.59	2.28
4030R	15/16"	I	4520	4510	4110	2.01	1.57	1.10	0.71	2.28
4032R	1"	I	4520	4510	4110	2.01	1.65	1.10	0.71	2.28
4034R	1-1/16"	I	4520	4510	4110	2.01	1.73	1.10	0.75	2.28
4036R	1-1/8"	I	4520	4510	4110	2.01	1.81	1.10	0.75	2.28
4038R	1-3/16"	I	4520	4510	4110	2.01	1.89	1.18	0.83	2.36
4040R	1-1/4"	II	4520	4510	4110	2.01	2.01	1.18	0.87	2.36
4042R	1-5/16"	III	4520	4510	4110	2.05	2.09	1.26	0.87	2.44
4044R	1-3/8"	III	4520	4510	4110	2.05	2.13	1.26	0.87	2.44
4046R	1-7/16"	III	4520	4510	4110	2.05	2.20	1.26	0.98	2.44
4048R	1-1/2"	III	4520	4510	4110	2.05	2.28	1.26	0.98	2.44
4050R	1-9/16"	III	4520	4510	4110	2.05	2.36	1.26	0.98	2.44
4052R	1-5/8"	III	4520	4510	4110	2.05	2.42	1.26	1.06	2.44
4054R	1-11/16"	III	4520	4510	4110	2.05	2.56	1.34	1.06	2.52
4056R	1-3/4"	III	4521	4511	4111	2.28	2.60	1.34	1.06	2.52
4058R	1-13/16"	III	4521	4511	4111	2.28	2.68	1.34	1.18	2.52
4060R	1-7/8"	III	4521	4511	4111	2.28	2.76	1.42	1.26	2.60
4062R	1-15/16"	III	4521	4511	4111	2.28	2.83	1.50	1.26	2.68
4064R	2"	III	4521	4511	4111	2.28	2.91	1.57	1.38	2.76
4066R	2-1/16"	III	4521	4511	4111	2.28	2.95	1.57	1.38	2.76
4068R	2-1/8"	III	4521	4511	4111	2.28	3.07	1.57	1.38	2.76
4070R	2-3/16"	III	4521	4512	4112	2.44	3.15	1.65	1.38	2.83
4072R	2-1/4"	III	4521	4512	4112	2.44	3.31	1.77	1.57	2.95
4074R	2-5/16"	III	4521	4512	4112	2.44	3.39	1.77	1.57	2.95
4076R	2-3/8"	III	4521	4512	4112	2.44	3.43	1.89	1.65	3.07
4078R	2-7/16"	III	4521	4512	4112	2.44	3.50	1.89	1.65	3.07
4080R	2-1/2"	III	4521	4512	4112	2.44	3.58	1.97	1.65	3.15
4082R	2-9/16"	III	4521	4512	4112	2.44	3.66	1.97	1.65	3.15
4084R	2-5/8"	III	4521	4512	4112	2.44	3.74	2.05	1.65	3.23
4086R	2-11/16"	III	4521	4512	4112	2.44	3.82	2.05	1.65	3.23
4088R	2-3/4"	III	4521	4512	4112	2.44	3.94	2.60	1.65	3.78
4090R	2-13/16"	III	4521	4512	4112	2.44	4.02	2.60	1.77	3.78
4092R	2-7/8"	III	4523	4513	-	3.39	4.09	2.60	1.77	3.78
4094R	2-15/16"	III	4523	4513	-	3.39	4.13	2.68	1.77	3.86
4096R	3"	III	4523	4513	-	3.39	4.21	2.68	1.89	3.94
4100R	3-1/8"	III	4523	4513	-	3.39	4.37	2.76	1.89	3.94
4104R	3-1/4"	III	4523	4513	-	3.39	4.53	2.76	1.89	3.94
4108R	3-3/8"	III	4523	4513	-	3.39	4.69	2.95	2.05	4.13
4112R	3-1/2"	III	4523	4513	-	3.39	4.88	2.95	2.05	4.13
4116R	3-5/8"	III	4523	4513	-	3.39	5.00	2.95	2.05	4.13
4120R	3-3/4"	III	4523	4513	-	3.39	5.16	3.27	2.05	4.53
4124R	3-7/8"	III	4523	4513	-	3.39	5.31	3.35	2.28	4.53
4128R	4"	III	4523	4513	-	3.39	5.47	3.35	2.28	4.53
4132R	4-1/8"	III	4524	4514	-	3.74	5.63	3.27	2.28	4.53
4136R	4-1/4"	III	4524	4514	-	3.74	5.79	3.35	2.36	4.53
4144R	4-1/2"	III	4524	4514	-	3.74	6.06	3.35	2.44	4.53

* Retaining devices key found on page 124.





1" Drive Standard Length Impact Sockets



6 1" Drive - Standard Length - Metric Sizes MM



ANSI Specifications B107.2

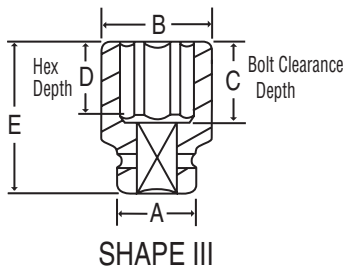

* Retaining devices key found on page 124.

Item Number	Hex Size	Shape	*Retaining Devices			Dimensions (Millimeters)				
			P	O	RI	A	B	C	D	E
4019M	19mm	I	4520	4510	4110	51	36.0	28	13	58
4020M	20mm	I	4520	4510	4110	51	37.0	28	14	58
4021M	21mm	I	4520	4510	4110	51	38.0	28	15	58
4022M	22mm	I	4520	4510	4110	51	39.0	28	15	58
4023M	23mm	I	4520	4510	4110	51	40.0	28	16	58
4024M	24mm	I	4520	4510	4110	51	40.0	28	18	58
4025M	25mm	I	4520	4510	4110	51	41.0	28	18	58
4026M	26mm	I	4520	4510	4110	51	42.5	28	18	58
4027M	27mm	I	4520	4510	4110	51	44.0	28	19	58
4028M	28mm	I	4520	4510	4110	51	45.0	28	19	58
4029M	29mm	I	4520	4510	4110	51	46.0	30	19	60
4030M	30mm	I	4520	4510	4110	51	48.0	30	21	60
4031M	31mm	I	4520	4510	4110	51	48.0	30	21	60
4032M	32mm	II	4520	4510	4110	51	51.0	30	22	60
4033M	33mm	III	4520	4510	4110	52	53.0	32	22	62
4034M	34mm	III	4520	4510	4110	52	54.0	32	22	62
4035M	35mm	III	4520	4510	4110	52	54.0	32	22	62
4036M	36mm	III	4520	4510	4110	52	56.0	32	25	62
4037M	37mm	III	4520	4510	4110	52	57.0	32	25	62
4038M	38mm	III	4520	4510	4110	52	58.0	32	25	62
4039M	39mm	III	4520	4510	4110	52	59.0	32	25	62
4040M	40mm	III	4520	4510	4110	52	60.0	32	25	62
4041M	41mm	III	4520	4510	4110	52	61.5	32	27	62
4042M	42mm	III	4520	4510	4110	52	63.0	34	27	64
4043M	43mm	III	4520	4510	4110	52	65.0	34	27	64
4044M	44mm	III	4520	4510	4110	52	65.0	34	27	64
4045M	45mm	III	4521	4511	4111	58	66.0	34	27	64
4046M	46mm	III	4521	4511	4111	58	68.0	34	30	64
4047M	47mm	III	4521	4511	4111	58	69.0	36	32	66
4048M	48mm	III	4521	4511	4111	58	70.0	38	32	68
4050M	50mm	III	4521	4511	4111	58	73.0	40	35	70
4051M	51mm	III	4521	4511	4111	58	74.0	40	35	70
4052M	52mm	III	4521	4511	4111	58	75.0	40	35	70
4053M	53mm	III	4521	4511	4111	58	75.0	40	35	70
4054M	54mm	III	4521	4511	4111	58	78.0	40	35	70
4055M	55mm	III	4521	4512	4112	62	79.0	42	35	72
4056M	56mm	III	4521	4512	4112	62	80.0	44	40	74
4057M	57mm	III	4521	4512	4112	62	84.0	45	40	75
4058M	58mm	III	4521	4512	4112	62	85.0	45	40	75
4060M	60mm	III	4521	4512	4112	62	87.0	48	42	78
4062M	62mm	III	4521	4512	4112	62	89.0	48	42	78
4063M	63mm	III	4521	4512	4112	62	91.0	50	42	80
4065M	65mm	III	4521	4512	4112	62	93.0	50	42	80
4067M	67mm	III	4521	4512	4112	62	95.0	52	42	82
4070M	70mm	III	4521	4512	4112	62	100.0	66	42	96
4075M	75mm	III	4523	4513	-	86	106.0	68	45	98
4076M	76mm	III	4523	4513	-	86	107.0	70	48	100
4077M	77mm	III	4523	4513	-	86	109.0	70	48	100
4078M	78mm	III	4523	4513	-	86	111.0	70	48	100
4080M	80mm	III	4523	4513	-	86	112.0	70	48	100
4085M	85mm	III	4523	4513	-	86	118.0	75	52	105
4090M	90mm	III	4523	4513	-	86	125.0	75	52	105
4095M	95mm	III	4523	4513	-	86	131.0	85	52	115
40100M	100mm	III	4523	4513	-	86	137.0	85	58	115
40105M	105mm	III	4523	4513	-	86	143.0	85	58	115
40110M	110mm	III	4523	4513	-	86	149.0	85	60	115
40115M	115mm	III	4524	4514	-	95	155.0	85	62	115



1" Drive Deep Length Impact Sockets



6 1" Drive - Deep Length - Fractional Sizes SAE



ANSI Specifications B107.2

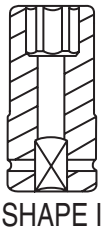

SHAPE I

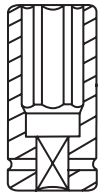

SHAPE II

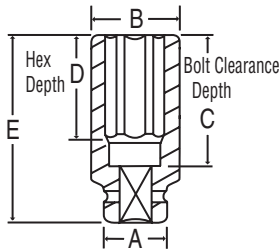

SHAPE III

Item Number	Hex Size	Shape	*Retaining Devices			Dimensions (Inches)				
			P	O	R1	A	B	C	D	E
4024D	3/4"	I	4520	4510	4110	2.01	1.42	2.36	0.75	3.54
4026D	13/16"	I	4520	4510	4110	2.01	1.50	2.36	0.87	3.54
4028D	7/8"	I	4520	4510	4110	2.01	1.54	2.36	0.87	3.54
4030D	15/16"	I	4520	4510	4110	2.01	1.57	2.36	0.94	3.54
4032D	1"	I	4520	4510	4110	2.01	1.65	2.36	0.98	3.54
4034D	1-1/16"	I	4520	4510	4110	2.01	1.73	2.36	1.06	3.54
4036D	1-1/8"	I	4520	4510	4110	2.01	1.81	2.36	1.14	3.54
4038D	1-3/16"	I	4520	4510	4110	2.01	1.89	2.36	1.18	3.54
4040D	1-1/4"	II	4520	4510	4110	2.01	2.01	2.36	1.26	3.54
4042D	1-5/16"	III	4520	4510	4110	2.05	2.09	2.36	1.34	3.54
4044D	1-3/8"	III	4520	4510	4110	2.05	2.13	2.36	1.38	3.54
4046D	1-7/16"	III	4520	4510	4110	2.05	2.20	2.36	1.46	3.54
4048D	1-1/2"	III	4520	4510	4110	2.05	2.28	2.44	1.50	3.62
4050D	1-9/16"	III	4520	4510	4110	2.05	2.36	2.44	1.50	3.62
4052D	1-5/8"	III	4520	4510	4110	2.05	2.42	2.44	1.50	3.62
4054D	1-11/16"	III	4520	4510	4110	2.05	2.56	2.44	1.50	3.62
4056D	1-3/4"	III	4521	4511	4111	2.28	2.60	2.44	1.50	3.62
4058D	1-13/16"	III	4521	4511	4111	2.28	2.68	2.44	1.50	3.62
4060D	1-7/8"	III	4521	4511	4111	2.28	2.76	2.44	1.50	3.62
4062D	1-15/16"	III	4521	4511	4111	2.28	2.83	2.44	1.50	3.62
4064D	2"	III	4521	4511	4111	2.28	2.91	2.56	1.57	3.74
4066D	2-1/16"	III	4521	4511	4111	2.28	2.95	2.56	1.57	3.74
4068D	2-1/8"	III	4521	4511	4111	2.28	3.07	2.76	1.57	3.94
4070D	2-3/16"	III	4521	4512	4112	2.44	3.15	2.76	1.57	3.94
4072D	2-1/4"	III	4521	4512	4112	2.44	3.31	2.76	1.57	3.94
4074D	2-5/16"	III	4521	4512	4112	2.44	3.39	2.95	1.57	4.13
4076D	2-3/8"	III	4521	4512	4112	2.44	3.43	2.95	1.65	4.13
4078D	2-7/16"	III	4521	4512	4112	2.44	3.50	3.15	1.65	4.33
4080D	2-1/2"	III	4521	4512	4112	2.44	3.58	3.15	1.65	4.33
4082D	2-9/16"	III	4521	4512	4112	2.44	3.66	3.74	1.65	4.92
4084D	2-5/8"	III	4521	4512	4112	2.44	3.74	3.74	1.65	4.92
4086D	2-11/16"	III	4521	4512	4112	2.44	3.82	3.74	1.65	4.92
4088D	2-3/4"	III	4521	4512	4112	2.44	3.94	3.74	1.65	4.92
4090D	2-13/16"	III	4521	4512	4112	2.44	4.02	3.74	1.77	4.92
4092D	2-7/8"	III	4523	4513	-	3.39	4.09	3.74	1.77	4.92
4094D	2-15/16"	III	4523	4513	-	3.39	4.13	4.13	1.77	5.31
4096D	3"	III	4523	4513	-	3.39	4.21	4.06	1.89	5.31
4100D	3-1/8"	III	4523	4513	-	3.39	4.37	4.13	1.89	5.31
4104D	3-1/4"	III	4523	4513	-	3.39	4.53	4.13	1.89	5.31
4108D	3-3/8"	III	4523	4513	-	3.39	4.69	4.33	2.05	5.51
4112D	3-1/2"	III	4523	4513	-	3.39	4.88	4.33	2.05	5.51
4116D	3-5/8"	III	4523	4513	-	3.39	5.00	4.33	2.05	5.51
4120D	3-3/4"	III	4523	4513	-	3.39	5.16	4.25	2.05	5.51
4124D	3-7/8"	III	4523	4513	-	3.39	5.31	4.33	2.28	5.51
4128D	4"	III	4523	4513	-	3.39	5.47	4.92	2.28	6.10
4132D	4-1/8"	III	4524	4514	-	3.74	5.63	4.84	2.28	6.10
4136D	4-1/4"	III	4524	4514	-	3.74	5.79	4.92	2.36	6.10
4144D	4-1/2"	III	4524	4514	-	3.74	6.06	4.92	2.44	6.10

* Retaining devices key found on page 124.



1" Drive Deep Length Impact Sockets



6 1" Drive - Deep Length - Metric Sizes ▲ MM



ANSI Specifications B107.2

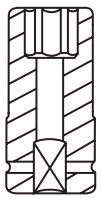

SHAPE I

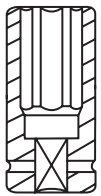

SHAPE II

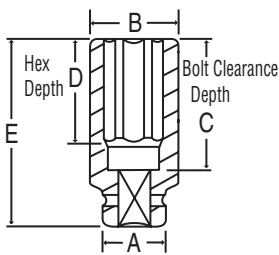

SHAPE III

* Retaining devices key found on page 124.

Item Number	Hex Size	Shape	*Retaining Devices			Dimensions (Millimeters)				
			P	O	R1	A	B	C	D	E
4019MD	19mm	I	4520	4510	4110	51	36.0	60	19	90
4020MD	20mm	I	4520	4510	4110	51	37.0	60	20	90
4021MD	21mm	I	4520	4510	4110	51	38.0	60	21	90
4022MD	22mm	I	4520	4510	4110	51	39.0	60	22	90
4023MD	23mm	I	4520	4510	4110	51	40.0	60	23	90
4024MD	24mm	I	4520	4510	4110	51	40.0	60	24	90
4025MD	25mm	I	4520	4510	4110	51	41.0	60	25	90
4026MD	26mm	I	4520	4510	4110	51	42.5	60	26	90
4027MD	27mm	I	4520	4510	4110	51	44.0	60	27	90
4028MD	28mm	I	4520	4510	4110	51	45.0	60	28	90
4029MD	29mm	I	4520	4510	4110	51	46.0	60	29	90
4030MD	30mm	I	4520	4510	4110	51	48.0	60	30	90
4031MD	31mm	I	4520	4510	4110	51	48.0	60	31	90
4032MD	32mm	II	4520	4510	4110	51	51.0	60	32	90
4033MD	33mm	II	4520	4510	4110	52	53.0	60	33	90
4034MD	34mm	III	4520	4510	4110	52	54.0	60	34	90
4035MD	35mm	III	4520	4510	4110	52	54.0	60	35	90
4036MD	36mm	III	4520	4510	4110	52	56.0	60	36	90
4037MD	37mm	III	4520	4510	4110	52	57.0	60	37	90
4038MD	38mm	III	4520	4510	4110	52	58.0	62	38	92
4039MD	39mm	III	4520	4510	4110	52	59.0	62	38	92
4040MD	40mm	III	4520	4510	4110	52	60.0	62	38	92
4041MD	41mm	III	4520	4510	4110	52	60.0	62	38	92
4042MD	42mm	III	4520	4510	4110	52	63.0	62	38	92
4043MD	43mm	III	4520	4510	4110	52	65.0	62	38	92
4044MD	44mm	III	4520	4510	4110	52	65.0	62	38	92
4045MD	45mm	III	4521	4511	4111	58	66.0	62	38	92
4046MD	46mm	III	4521	4511	4111	58	68.0	62	38	92
4047MD	47mm	III	4521	4511	4111	58	69.0	62	38	92
4048MD	48mm	III	4521	4511	4111	58	70.0	62	38	92
4050MD	50mm	III	4521	4511	4111	58	73.0	65	38	95
4051MD	51mm	III	4521	4511	4111	58	74.0	65	40	95
4052MD	52mm	III	4521	4511	4111	58	75.0	65	40	95
4053MD	53mm	III	4521	4511	4111	58	75.0	65	40	95
4054MD	54mm	III	4521	4511	4111	58	78.0	70	40	100
4055MD	55mm	III	4521	4512	4112	62	79.0	70	40	100
4056MD	56mm	III	4521	4512	4112	62	80.0	70	40	100
4057MD	57mm	III	4521	4512	4112	62	84.0	70	40	100
4058MD	58mm	III	4521	4512	4112	62	85.0	75	40	105
4060MD	60mm	III	4521	4512	4112	62	87.0	75	42	105
4062MD	62mm	III	4521	4512	4112	62	89.0	80	42	110
4063MD	63mm	III	4521	4512	4112	62	91.0	80	42	110
4065MD	65mm	III	4521	4512	4112	62	93.0	95	42	125
4067MD	67mm	III	4521	4512	4112	62	95.0	95	42	125
4070MD	70mm	III	4521	4512	4112	62	100.0	95	42	125
4075MD	75mm	III	4523	4513	-	86	106.0	105	45	135
4076MD	76mm	III	4523	4513	-	86	107.0	105	48	135
4077MD	77mm	III	4523	4513	-	86	109.0	105	48	135
4078MD	78mm	III	4523	4513	-	86	110.0	105	48	135
4080MD	80mm	III	4523	4513	-	86	112.0	105	48	135
4085MD	85mm	III	4523	4513	-	86	118.0	110	52	140
4090MD	90mm	III	4523	4513	-	86	125.0	110	52	140
4095MD	95mm	III	4523	4513	-	86	131.0	110	52	140
40100MD	100mm	III	4523	4513	-	86	137.0	110	58	140
40105MD	105mm	III	4524	4514	-	95	143.0	125	58	155
40110MD	110mm	III	4524	4514	-	95	149.0	125	60	155
40115MD	115mm	III	4524	4514	-	95	155.0	125	62	155



1" Drive 12-Point Standard Length Impact Sockets



12 1" Drive 12-Point - Standard Length - Fractional Sizes SAE



ANSI Specifications B107.2

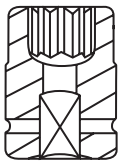

SHAPE I

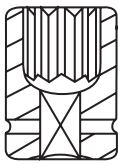

SHAPE II

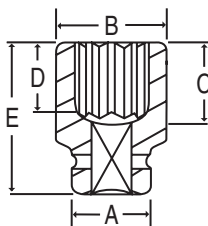

SHAPE III

Item Number	12-Point Size	Shape	*Retaining Devices			Dimensions (Inches)				
			P	O	R1	A	B	C	D	E
4224R	3/4"	I	4520	4510	4110	2.13	1.42	1.18	0.51	2.36
4226R	13/16"	I	4520	4510	4110	2.13	1.50	1.18	0.59	2.36
4228R	7/8"	I	4520	4510	4110	2.13	1.54	1.18	0.59	2.36
4230R	15/16"	I	4520	4510	4110	2.13	1.65	1.18	0.71	2.36
4232R	1"	I	4520	4510	4110	2.13	1.73	1.18	0.71	2.36
4234R	1-1/16"	I	4520	4510	4110	2.13	1.81	1.18	0.75	2.36
4236R	1-1/8"	I	4520	4510	4110	2.13	1.89	1.26	0.75	2.44
4238R	1-3/16"	I	4520	4510	4110	2.13	1.97	1.26	0.83	2.44
4240R	1-1/4"	I	4520	4510	4110	2.13	2.05	1.26	0.87	2.44
4242R	1-5/16"	II	4520	4510	4110	2.13	2.13	1.26	0.87	2.44
4244R	1-3/8"	III	4520	4510	4110	2.13	2.20	1.38	0.87	2.56
4246R	1-7/16"	III	4520	4510	4110	2.13	2.28	1.46	0.98	2.64
4248R	1-1/2"	III	4520	4510	4110	2.13	2.36	1.46	0.98	2.64
4250R	1-9/16"	III	4520	4510	4110	2.13	2.44	1.57	0.98	2.76
4252R	1-5/8"	III	4520	4510	4110	2.13	2.50	1.57	1.06	2.76
4254R	1-11/16"	III	4520	4510	4110	2.13	2.60	1.73	1.06	2.91
4256R	1-3/4"	III	4520	4510	4110	2.13	2.66	1.73	1.06	2.91
4258R	1-13/16"	III	4521	4511	4111	2.28	2.76	1.81	1.18	2.99
4260R	1-7/8"	III	4521	4511	4111	2.28	2.83	1.81	1.26	2.99
4262R	1-15/16"	III	4521	4511	4111	2.28	2.91	1.97	1.26	3.15
4264R	2"	III	4521	4512	4112	2.44	2.99	1.97	1.38	3.15
4266R	2-1/16"	III	4521	4512	4112	2.44	3.05	2.13	1.38	3.31
4268R	2-1/8"	III	4521	4512	4112	2.44	3.15	2.13	1.38	3.31
4270R	2-3/16"	III	4521	4512	4112	2.44	3.21	2.13	1.38	3.31
4272R	2-1/4"	III	4521	4512	4112	2.44	3.31	2.13	1.57	3.31
4274R	2-5/16"	III	4521	4512	4112	2.44	3.39	2.24	1.57	3.43
4276R	2-3/8"	III	4521	4512	4112	2.44	3.43	2.24	1.65	3.43
4278R	2-7/16"	III	4521	4512	4112	2.44	3.50	2.24	1.65	3.43
4280R	2-1/2"	III	4521	4512	4112	2.44	3.58	2.24	1.65	3.43
4282R	2-9/16"	III	4521	4512	4112	2.44	3.66	2.36	1.65	3.54
4284R	2-5/8"	III	4521	4512	4112	2.44	3.74	2.44	1.65	3.62
4286R	2-11/16"	III	4521	4512	4112	2.44	3.82	2.44	1.65	3.62
4288R	2-3/4"	III	4521	4512	4112	2.44	3.94	2.60	1.65	3.78
4290R	2-13/16"	III	4521	4512	4112	2.44	4.02	2.60	1.77	3.78
4292R	2-7/8"	III	4523	4513	-	3.39	4.09	2.60	1.77	3.78
4294R	2-15/16"	III	4523	4513	-	3.39	4.13	2.68	1.77	3.86
4296R	3"	III	4523	4513	-	3.39	4.21	2.76	1.89	3.94
4300R	3-1/8"	III	4523	4513	-	3.39	4.37	2.76	1.89	3.94
4304R	3-1/4"	III	4523	4513	-	3.39	4.53	2.76	1.89	3.94
4308R	3-3/8"	III	4523	4513	-	3.39	4.69	2.95	2.05	4.13
4312R	3-1/2"	III	4523	4513	-	3.39	4.88	2.95	2.05	4.13
4316R	3-5/8"	III	4523	4513	-	3.39	5.00	2.95	2.05	4.13
4320R	3-3/4"	III	4523	4513	-	3.39	5.16	3.35	2.05	4.53
4324R	3-7/8"	III	4523	4513	-	3.39	5.31	3.35	2.28	4.53
4328R	4"	III	4523	4513	-	3.39	5.47	3.35	2.28	4.53
4332R	4-1/8"	III	4524	4514	-	3.74	5.63	3.35	2.28	4.53
4336R	4-1/4"	III	4524	4514	-	3.74	5.79	3.35	2.36	4.53
4344R	4-1/2"	III	4524	4514	-	3.74	6.06	3.35	2.44	4.53

* Retaining devices key found on page 124.



1" Drive 12-Point Standard Length Impact Sockets



12 1" Drive 12-Point - Standard Length - Metric Sizes MM



ANSI Specifications B107.2

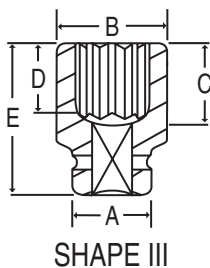
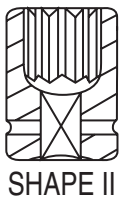

* Retaining devices key found on page 124.

Item Number	12-Point Size	Shape	*Retaining Devices			Dimensions (Millimeters)				
			P	O	R1	A	B	C	D	E
4119M	19mm	I	4520	4510	4110	54	36.0	30	13	60
4120M	20mm	I	4520	4510	4110	54	37.0	30	14	60
4121M	21mm	I	4520	4510	4110	54	38.0	30	15	60
4122M	22mm	I	4520	4510	4110	54	40.0	30	15	60
4123M	23mm	I	4520	4510	4110	54	41.0	30	16	60
4124M	24mm	I	4520	4510	4110	54	42.0	30	18	60
4125M	25mm	I	4520	4510	4110	54	43.0	30	18	60
4126M	26mm	I	4520	4510	4110	54	44.5	30	18	60
4127M	27mm	I	4520	4510	4110	54	46.0	30	19	60
4128M	28mm	I	4520	4510	4110	54	47.0	32	19	62
4129M	29mm	I	4520	4510	4110	54	48.0	32	19	62
4130M	30mm	I	4520	4510	4110	54	50.0	32	21	62
4131M	31mm	I	4520	4510	4110	54	51.0	32	21	62
4132M	32mm	I	4520	4510	4110	54	52.0	32	22	62
4133M	33mm	I	4520	4510	4110	54	53.0	32	22	62
4134M	34mm	III	4520	4510	4110	54	55.0	32	22	62
4135M	35mm	III	4520	4510	4110	54	56.0	35	22	65
4136M	36mm	III	4520	4510	4110	54	57.0	37	25	67
4137M	37mm	III	4520	4510	4110	54	59.0	37	25	67
4138M	38mm	III	4520	4510	4110	54	60.0	37	25	67
4139M	39mm	III	4520	4510	4110	54	61.0	40	25	70
4140M	40mm	III	4520	4510	4110	54	62.0	40	25	70
4141M	41mm	III	4520	4510	4110	54	63.0	40	27	70
4142M	42mm	III	4520	4510	4110	54	65.0	44	27	74
4143M	43mm	III	4520	4510	4110	54	66.0	44	27	74
4144M	44mm	III	4520	4510	4110	54	67.0	44	27	74
4145M	45mm	III	4520	4510	4110	54	68.0	44	27	74
4146M	46mm	III	4521	4511	4111	58	70.0	46	30	76
4147M	47mm	III	4521	4511	4111	58	71.5	46	32	76
4148M	48mm	III	4521	4511	4111	58	72.5	46	32	76
4150M	50mm	III	4521	4512	4112	62	75.0	50	35	80
4151M	51mm	III	4521	4512	4112	62	76.0	50	35	80
4152M	52mm	III	4521	4512	4112	62	77.0	54	35	84
4153M	53mm	III	4521	4512	4112	62	78.0	54	35	84
4154M	54mm	III	4521	4512	4112	62	80.0	54	35	84
4155M	55mm	III	4521	4512	4112	62	81.0	54	35	84
4156M	56mm	III	4521	4512	4112	62	82.0	54	40	84
4157M	57mm	III	4521	4512	4112	62	84.0	54	40	84
4158M	58mm	III	4521	4512	4112	62	85.0	57	40	87
4160M	60mm	III	4521	4512	4112	62	87.0	57	42	87
4162M	62mm	III	4521	4512	4112	62	89.0	57	42	87
4163M	63mm	III	4521	4512	4112	62	90.0	57	42	87
4165M	65mm	III	4521	4512	4112	62	93.0	60	42	90
4167M	67mm	III	4521	4512	4112	62	96.0	62	42	92
4170M	70mm	III	4521	4512	4112	62	100.0	66	42	96
4175M	75mm	III	4523	4513	-	86	106.0	68	45	98
4176M	76mm	III	4523	4513	-	86	107.0	70	48	100
4177M	77mm	III	4523	4513	-	86	109.0	70	48	100
4178M	78mm	III	4523	4513	-	86	110.0	70	48	100
4180M	80mm	III	4523	4513	-	86	112.0	70	48	100
4185M	85mm	III	4523	4513	-	86	118.0	75	52	105
4190M	90mm	III	4523	4513	-	86	125.0	75	52	105
4195M	95mm	III	4523	4513	-	86	131.0	85	52	115
41100M	100mm	III	4523	4513	-	86	137.0	85	58	115
41105M	105mm	III	4524	4514	-	95	143.0	85	58	115
41110M	110mm	III	4524	4514	-	95	149.0	85	60	115
41115M	115mm	III	4524	4514	-	95	155.0	85	62	115



1" Drive 12-Point Deep Length Impact Sockets



12 1" Drive 12-Point - Deep Length - Fractional Sizes

SAE



ANSI Specifications B107.2

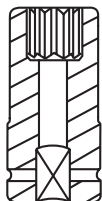

SHAPE I

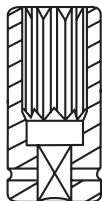

SHAPE II

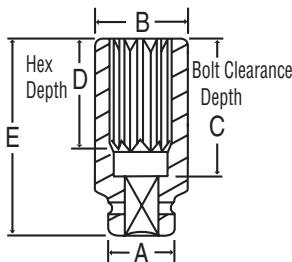

SHAPE III

Item Number	12-Point Size	Shape	*Retaining Devices			Dimensions (Inches)				
			P	O	R1	A	B	C	D	E
4224D	3/4"	I	4520	4510	4110	2.13	1.42	2.76	0.75	3.94
4226D	13/16"	I	4520	4510	4110	2.13	1.50	2.76	0.87	3.94
4228D	7/8"	I	4520	4510	4110	2.13	1.54	2.76	0.87	3.94
4230D	15/16"	I	4520	4510	4110	2.13	1.65	2.76	0.94	3.94
4232D	1"	I	4520	4510	4110	2.13	1.73	2.76	0.98	3.94
4234D	1-1/16"	I	4520	4510	4110	2.13	1.81	2.76	1.06	3.94
4236D	1-1/8"	I	4520	4510	4110	2.13	1.89	2.76	1.14	3.94
4238D	1-3/16"	I	4520	4510	4110	2.13	1.97	2.76	1.18	3.94
4240D	1-1/4"	I	4520	4510	4110	2.13	2.05	2.76	1.26	3.94
4242D	1-5/16"	II	4520	4510	4110	2.13	2.13	2.76	1.34	3.94
4244D	1-3/8"	III	4520	4510	4110	2.13	2.20	2.76	1.38	3.94
4246D	1-7/16"	III	4520	4510	4110	2.13	2.28	2.76	1.46	3.94
4248D	1-1/2"	III	4520	4510	4110	2.13	2.36	2.76	1.50	3.94
4250D	1-9/16"	III	4520	4510	4110	2.13	2.44	2.76	1.50	3.94
4252D	1-5/8"	III	4520	4510	4110	2.13	2.50	2.76	1.50	3.94
4254D	1-11/16"	III	4520	4510	4110	2.13	2.60	2.76	1.50	3.94
4256D	1-3/4"	III	4520	4510	4110	2.13	2.66	2.76	1.50	3.94
4258D	1-13/16"	III	4521	4511	4111	2.28	2.76	2.76	1.50	3.94
4260D	1-7/8"	III	4521	4511	4111	2.28	2.83	2.76	1.50	3.94
4262D	1-15/16"	III	4521	4511	4111	2.28	2.91	2.76	1.50	3.94
4264D	2"	III	4521	4512	4112	2.44	2.99	2.76	1.57	3.94
4266D	2-1/16"	III	4521	4512	4112	2.44	3.05	2.76	1.57	3.94
4268D	2-1/8"	III	4521	4512	4112	2.44	3.15	2.76	1.57	3.94
4270D	2-3/16"	III	4521	4512	4112	2.44	3.21	2.76	1.57	3.94
4272D	2-1/4"	III	4521	4512	4112	2.44	3.31	2.95	1.57	4.13
4274D	2-5/16"	III	4521	4512	4112	2.44	3.39	2.95	1.57	4.13
4276D	2-3/8"	III	4521	4512	4112	2.44	3.43	3.54	1.65	4.72
4278D	2-7/16"	III	4521	4512	4112	2.44	3.50	3.54	1.65	4.72
4280D	2-1/2"	III	4521	4512	4112	2.44	3.58	3.54	1.65	4.72
4282D	2-9/16"	III	4521	4512	4112	2.44	3.66	3.74	1.65	4.92
4284D	2-5/8"	III	4521	4512	4112	2.44	3.74	3.74	1.65	4.92
4286D	2-11/16"	III	4521	4512	4112	2.44	3.82	3.74	1.65	4.92
4288D	2-3/4"	III	4521	4512	4112	2.44	3.94	3.74	1.65	4.92
4290D	2-13/16"	III	4521	4512	4112	2.44	4.02	3.74	1.77	4.92
4292D	2-7/8"	III	4523	4513	-	3.39	4.09	3.74	1.77	4.92
4294D	2-15/16"	III	4523	4513	-	3.39	4.13	4.13	1.77	5.31
4296D	3"	III	4523	4513	-	3.39	4.21	4.13	1.89	5.31
4300D	3-1/8"	III	4523	4513	-	3.39	4.37	4.13	1.89	5.31
4304D	3-1/4"	III	4523	4513	-	3.39	4.53	4.13	1.89	5.31
4308D	3-3/8"	III	4523	4513	-	3.39	4.69	4.33	2.05	5.51
4312D	3-1/2"	III	4523	4513	-	3.39	4.88	4.33	2.05	5.51
4316D	3-5/8"	III	4523	4513	-	3.39	5.00	4.33	2.05	5.51
4320D	3-3/4"	III	4523	4513	-	3.39	5.16	4.33	2.05	5.51
4324D	3-7/8"	III	4523	4513	-	3.39	5.31	4.33	2.28	5.51
4328D	4"	III	4523	4513	-	3.39	5.47	4.92	2.28	6.10
4332D	4-1/8"	III	4524	4514	-	3.74	5.63	4.92	2.28	6.10
4336D	4-1/4"	III	4524	4514	-	3.74	5.79	4.92	2.36	6.10
4344D	4-1/2"	III	4524	4514	-	3.74	6.06	4.92	2.44	6.10

* Retaining devices key found on page 124.





1" Drive 12-Point Deep Length Impact Sockets



12 1" Drive - 12-Point - Deep Length - Metric Sizes MM



ANSI Specifications B107.2

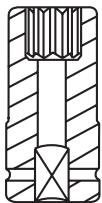

SHAPE I

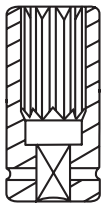

SHAPE II

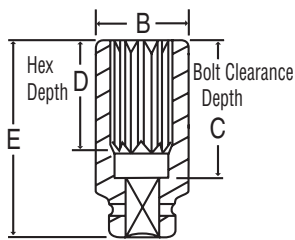

SHAPE III

* Retaining Devices Key found on page 124.

Item Number	12-Point Size	Shape	*Retaining Devices			Dimensions (Millimeters)				
			P	O	R1	A	B	C	D	E
4119MD	19mm	I	4520	4510	4110	54	36.0	70	19	100
4120MD	20mm	I	4520	4510	4110	54	37.0	70	20	100
4121MD	21mm	I	4520	4510	4110	54	38.0	70	21	100
4122MD	22mm	I	4520	4510	4110	54	40.0	70	22	100
4123MD	23mm	I	4520	4510	4110	54	41.0	70	23	100
4124MD	24mm	I	4520	4510	4110	54	42.0	70	24	100
4125MD	25mm	I	4520	4510	4110	54	43.0	70	25	100
4126MD	26mm	I	4520	4510	4110	54	44.5	70	26	100
4127MD	27mm	I	4520	4510	4110	54	46.0	70	27	100
4128MD	28mm	I	4520	4510	4110	54	47.0	70	28	100
4129MD	29mm	I	4520	4510	4110	54	48.0	70	29	100
4130MD	30mm	I	4520	4510	4110	54	50.0	70	30	100
4131MD	31mm	I	4520	4510	4110	54	51.0	70	31	100
4132MD	32mm	I	4520	4510	4110	54	52.0	70	32	100
4133MD	33mm	I	4520	4510	4110	54	53.0	70	33	100
4134MD	34mm	III	4520	4510	4110	54	55.0	70	34	100
4135MD	35mm	III	4520	4510	4110	54	56.0	70	35	100
4136MD	36mm	III	4520	4510	4110	54	57.0	70	36	100
4137MD	37mm	III	4520	4510	4110	54	59.0	70	37	100
4138MD	38mm	III	4520	4510	4110	54	60.0	70	38	100
4139MD	39mm	III	4520	4510	4110	54	61.0	70	38	100
4140MD	40mm	III	4520	4510	4110	54	62.0	70	38	100
4141MD	41mm	III	4520	4510	4110	54	63.0	70	38	100
4142MD	42mm	III	4520	4510	4110	54	65.0	70	38	100
4143MD	43mm	III	4520	4510	4110	54	66.0	70	38	100
4144MD	44mm	III	4520	4510	4110	54	67.0	70	38	100
4145MD	45mm	III	4520	4510	4110	54	68.0	70	38	100
4146MD	46mm	III	4521	4511	4111	58	70.0	70	38	100
4147MD	47mm	III	4521	4511	4111	58	71.5	70	38	100
4148MD	48mm	III	4521	4511	4111	58	72.5	70	38	100
4150MD	50mm	III	4521	4512	4112	62	75.0	70	38	100
4151MD	51mm	III	4521	4512	4112	62	76.0	70	40	100
4152MD	52mm	III	4521	4512	4112	62	77.0	70	40	100
4153MD	53mm	III	4521	4512	4112	62	78.0	70	40	100
4154MD	54mm	III	4521	4512	4112	62	80.0	70	40	100
4155MD	55mm	III	4521	4512	4112	62	81.0	70	40	100
4156MD	56mm	III	4521	4512	4112	62	82.0	75	40	105
4157MD	57mm	III	4521	4512	4112	62	84.0	75	40	105
4158MD	58mm	III	4521	4512	4112	62	85.0	75	40	105
4160MD	60mm	III	4521	4512	4112	62	87.0	90	42	120
4162MD	62mm	III	4521	4512	4112	62	89.0	90	42	120
4163MD	63mm	III	4521	4512	4112	62	90.0	90	42	120
4165MD	65mm	III	4521	4512	4112	62	93.0	95	42	125
4167MD	67mm	III	4521	4512	4112	62	96.0	95	42	125
4170MD	70mm	III	4521	4512	4112	62	100.0	95	42	125
4175MD	75mm	III	4523	4513	-	86	106.0	105	45	135
4176MD	76mm	III	4523	4513	-	86	107.0	105	48	135
4177MD	77mm	III	4523	4513	-	86	109.0	105	48	135
4178MD	78mm	III	4523	4513	-	86	110.0	105	48	135
4180MD	80mm	III	4523	4513	-	86	112.0	105	48	135
4185MD	85mm	III	4523	4513	-	86	118.0	110	52	140
4190MD	90mm	III	4523	4513	-	86	125.0	110	52	140
4195MD	95mm	III	4523	4513	-	86	131.0	110	52	140
41100MD	100mm	III	4523	4513	-	86	137.0	110	58	140
41105MD	105mm	III	4524	4514	-	95	143.0	125	58	155
41110MD	110mm	III	4524	4514	-	95	149.0	125	60	155
41115MD	115mm	III	4524	4514	-	95	155.0	125	62	155



1" Drive Heavy Duty Universal Impact Sockets



6 1" Drive - Heavy Duty Universal - Fractional Sizes SAE

This Heavy-Duty design features a rotating ball U-joint for smoother operation & maximum durability under demanding conditions. The smooth operation also allows more torque to reach the fastener.



Item Number	Hex Size	*Retaining Devices			Dimensions (Inches)			
		P	O	R1	A	B	C	E
4028U	7/8"	4521	4511	4111	2.28	1.54	0.79	5.20
4030U	15/16"	4521	4511	4111	2.28	1.57	0.79	5.20
4032U	1"	4521	4511	4111	2.28	1.65	0.79	5.20
4034U	1-1/16"	4521	4511	4111	2.28	1.73	0.79	5.20
4036U	1-1/8"	4521	4511	4111	2.28	1.81	0.79	5.20
4038U	1-3/16"	4521	4511	4111	2.28	1.97	0.79	5.20
4040U	1-1/4"	4521	4511	4111	2.28	2.05	0.79	5.20
4042U	1-5/16"	4521	4511	4111	2.28	2.17	0.83	5.20
4044U	1-3/8"	4521	4511	4111	2.28	2.17	0.91	5.20
4046U	1-7/16"	4521	4511	4111	2.28	2.20	0.91	5.20
4048U	1-1/2"	4521	4511	4111	2.28	2.32	0.94	5.39
4050U	1-9/16"	4521	4511	4111	2.28	2.44	0.94	5.39
4052U	1-5/8"	4521	4511	4111	2.28	2.48	1.02	5.39
4054U	1-11/16"	4521	4511	4111	2.28	2.60	1.02	5.39
4056U	1-3/4"	4521	4511	4111	2.28	2.68	1.18	5.59
4058U	1-13/16"	4521	4511	4111	2.28	2.72	1.18	5.59
4060U	1-7/8"	4521	4511	4111	2.28	2.87	1.18	5.59
4062U	1-15/16"	4521	4511	4111	2.28	2.91	1.22	5.59
4064U	2"	4521	4511	4111	2.28	2.99	1.22	5.59

6 Heavy Duty Universal - Metric Sizes MM

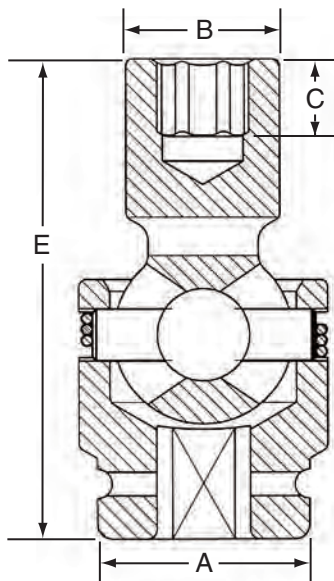

Item Number	Hex Size	*Retaining Devices			Dimensions (Millimeters)			
		P	O	R1	A	B	C	E
4024UM	24mm	4521	4511	4111	58	40	20	132
4026UM	26mm	4521	4511	4111	58	42	20	132
4027UM	27mm	4521	4511	4111	58	44	20	132
4029UM	29mm	4521	4511	4111	58	48	20	132
4030UM	30mm	4521	4511	4111	58	50	20	132
4032UM	32mm	4521	4511	4111	58	52	20	132
4033UM	33mm	4521	4511	4111	58	53	21	132
4034UM	34mm	4521	4511	4111	58	55	21	132
4035UM	35mm	4521	4511	4111	58	55	23	132
4036UM	36mm	4521	4511	4111	58	56	23	132
4038UM	38mm	4521	4511	4111	58	59	24	137
4041UM	41mm	4521	4511	4111	58	63	26	137
4042UM	42mm	4521	4511	4111	58	64	26	137
4043UM	43mm	4521	4511	4111	58	66	26	137
4044UM	44mm	4521	4511	4111	58	67	26	137
4045UM	45mm	4521	4511	4111	58	68	30	142
4046UM	46mm	4521	4511	4111	58	69	30	142
4047UM	47mm	4521	4511	4111	58	72	30	142
4048UM	48mm	4521	4511	4111	58	73	30	142
4050UM	50mm	4521	4511	4111	58	74	31	142

* Retaining Devices Key found on page 124.



1" Drive 8-Point Impact Sockets



8 1" Drive 8-Point - Standard Length - Fractional Sizes SAE

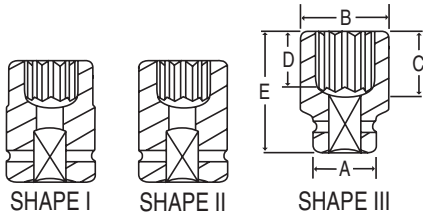

Item Number	8-Point Size	Shape	Dimensions (Inches)				
			A	B	C	D	E
4524S	3/4"	I	2.13	1.77	1.18	.51	2.36
4526S	13/16"	I	2.13	1.85	1.18	.59	2.36
4528S	7/8"	I	2.13	1.95	1.18	.59	2.36
4530S	15/16"	I	2.13	2.05	1.18	.71	2.36
4532S	1"	II	2.13	2.13	1.18	.71	2.36
4534S	1-1/16"	III	2.13	2.22	1.18	.75	2.36
4536S	1-1/8"	III	2.13	2.32	1.26	.75	2.44
4538S	1-3/16"	III	2.13	2.40	1.26	.83	2.44
4540S	1-1/4"	III	2.13	2.52	1.26	.87	2.44
4542S	1-5/16"	III	2.13	2.60	1.26	.87	2.44
4544S	1-3/8"	III	2.28	2.70	1.38	.87	2.56
4546S	1-7/16"	III	2.28	2.80	1.46	.94	2.64
4548S	1-1/2"	III	2.28	2.87	1.46	.94	2.64
4550S	1-9/16"	III	2.28	2.95	1.46	.94	2.64
4552S	1-5/8"	III	2.28	3.07	1.57	1.06	2.76
4554S	1-11/16"	III	2.44	3.21	1.73	1.06	2.91
4556S	1-3/4"	III	2.44	3.31	1.73	1.06	2.91
4558S	1-13/16"	III	2.44	3.39	1.81	1.18	2.99
4560S	1-7/8"	III	2.44	3.48	1.81	1.18	2.99
4562S	1-15/16"	III	2.44	3.62	1.97	1.18	3.15
4564S	2"	III	2.44	3.70	1.97	1.26	3.15
4566S	2-1/16"	III	2.44	3.78	2.13	1.26	3.31
4568S	2-1/8"	III	2.44	3.86	2.13	1.26	3.31
4570S	2-3/16"	III	2.44	3.98	2.13	1.38	3.31
4572S	2-1/4"	III	2.44	4.06	2.13	1.38	3.31

8 1" Drive 8-Point - Deep Length - Fractional Sizes SAE

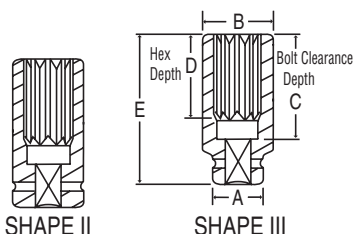

Item Number	8-Point Size	Shape	Dimensions (Inches)				
			A	B	C	D	E
4532SD	1"	II	2.13	2.13	2.76	0.71	3.94
4534SD	1-1/16"	III	2.13	2.22	2.76	0.75	3.94
4536SD	1-1/8"	III	2.13	2.32	2.76	0.75	3.94
4538SD	1-3/16"	III	2.13	2.40	2.76	0.83	3.94
4540SD	1-1/4"	III	2.13	2.52	2.76	0.87	3.94
4542SD	1-5/16"	III	2.13	2.60	2.76	0.87	3.94
4544SD	1-3/8"	III	2.28	2.70	2.76	0.87	3.94
4546SD	1-7/16"	III	2.28	2.80	2.76	0.94	3.94
4548SD	1-1/2"	III	2.28	2.87	2.76	0.94	3.94
4550SD	1-9/16"	III	2.28	2.95	2.76	0.94	3.94
4552SD	1-5/8"	III	2.28	3.07	2.76	1.06	3.94
4554SD	1-11/16"	III	2.44	3.21	2.76	1.06	3.94
4556SD	1-3/4"	III	2.44	3.31	2.76	1.06	3.94
4558SD	1-13/16"	III	2.44	3.39	2.76	1.18	3.94
4560SD	1-7/8"	III	2.44	3.48	2.76	1.18	3.94
4562SD	1-15/16"	III	2.44	3.62	2.76	1.18	3.94
4564SD	2"	III	2.44	3.70	2.76	1.26	3.94
4566SD	2-1/16"	III	2.44	3.78	2.76	1.26	3.94
4568SD	2-1/8"	III	2.44	3.86	2.76	1.26	3.94
4570SD	2-3/16"	III	2.44	3.98	2.76	1.38	3.94
4572SD	2-1/4"	III	2.44	4.06	2.95	1.38	4.13



1" Drive Special Application Impact Sockets



6 1" Drive Extra Deep Thin Wall Sockets

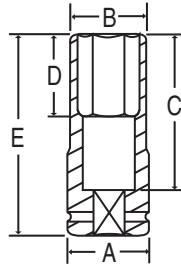

Designed for truck wheel service when removing lug nuts that are deeply recessed and where space is very limited.

Item Number	Hex Size	Dimensions (Inches/Millimeters)				
		A	B	C	D	E
4034DT	1-1/16"	2.01	1.67	3.07	1.69	4.25
4036DT	1-1/8"	2.01	1.69	3.07	1.69	4.25
4040DT	1-1/4"	2.01	1.85	3.07	1.69	4.25
4042DT	1-5/16"	2.01	1.93	3.07	1.69	4.25
4048DT	1-1/2"	2.13	2.13	3.07	1.69	4.25
4056DT	1-3/4"	2.13	2.44	3.07	1.69	4.25
4035MDT	35mm	54	52	78	43	108
4041MDT	41mm	54	57	78	43	108

6 1" Drive Budd Wheel Socket - 1-1/2" Limited Hex

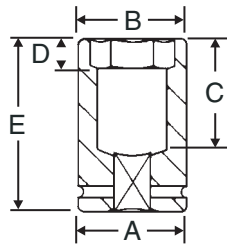

Special 1-1/2" hex deep heavy duty impact socket designed for outer cap nuts on budd-style truck wheels. The 1-1/2" hex depth is limited to help prevent socket contact with the wheel. The socket is deep style to eliminate contact with the inner cap nut.

Item Number	Hex Size	Dimensions (Inches)				
		A	B	C	D	E
4048DB	1-1/2"	2.13	2.24	2.36	.55	3.54

6 1" Drive Budd Wheel Socket - 1-1/2" Deep Hex

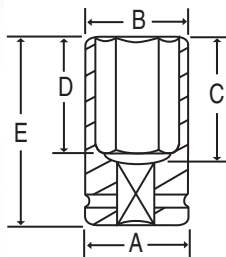

Special 1-1/2" hex deep heavy duty impact socket designed for outer cap nuts on budd-style truck wheels. The 1-1/2" hex depth is deep in length. The socket is a deep style to eliminate contact with the inner cap nut.

Item Number	Hex Size	Dimensions (Inches)				
		A	B	C	D	E
4048DS	1-1/2"	2.36	2.36	2.83	2.60	4.02

6 1" Drive Combination Budd Wheel Sockets

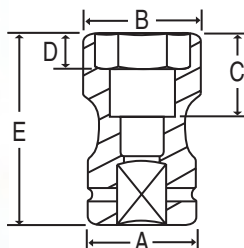

Removes and installs budd-type wheel fasteners. Sockets have two openings, eliminating the need for two separate sockets. Fractional and metric sizes.

Item Number	Hex Size	Square Size	Dimensions (Inches/Millimeters)				
			A	B	C	D	E
4223C	1-1/2"	13/16"	2.24	2.24	2.56	.55	3.98
4235MC	35mm	17mm	52	54	59	13	94
4238MC	38mm	20mm	54	58	59	14	101
4241MC	41mm	21mm	54	56	60	14	96



1" Drive Special Application Impact Sockets



4 1" Drive 4-Point (Square) Standard Length Sockets



Designed specifically for inner budd-style square fasteners on truck wheels. Fractional and metric sizes.

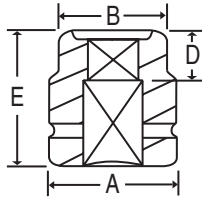

Item Number	Square Size	Dimensions (Inches/Millimeters)			
		A	B	D	E
4313S	13/16"	2.05	1.73	.94	2.24
4315S	15/16"	2.05	1.73	.94	2.24
4317S	17mm	52	40	24	57
4319S	19mm	52	40	24	57
4320S	20mm	52	40	24	57
4321S	21mm	52	40	24	57

4 1" Drive 4-Point (Square) Deep Length Socket



Designed for inner budd-style square fasteners on truck wheels where a deep style impact socket is desired.

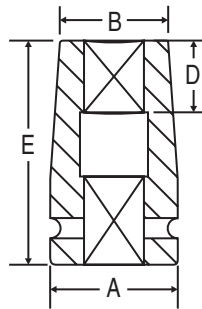

Item Number	Square Size	Dimensions (Inches)			
		A	B	D	E
4313SL	13/16"	2.13	1.81	1.10	3.74

4 1" Drive 4-Point Heavy Duty (Square) Socket



Designed specifically for inner budd-style square fasteners on truck wheels.

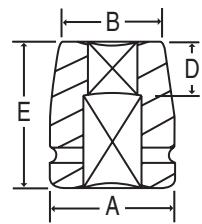

Item Number	Square Size	Dimensions (Inches)			
		A	B	D	E
4313SHD	13/16"	2.24	1.89	.94	2.68

6 1" Drive Extra Deep Socket



A special 1-3/4" extra deep impact socket for applications where a deep impact socket will not reach the fastener.

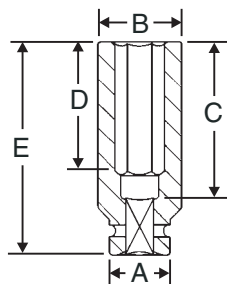

Item Number	Hex Size	Dimensions (Inches)				
		A	B	C	D	E
4056XD	1-3/4"	2.28	2.60	3.54	2.91	4.72



6 1" Drive Extended Depth Sockets



Extended depth impact sockets with the opening (bolt clearance depth) extending the complete length of the socket.



Item Number	Hex Size	Dimensions (Inches/Millimeters)				
		A	B	C	D	E
4633ML	33mm	54	52	240	32	270
4634L	1-1/4"	2.13	2.01	9.45	1.26	10.63

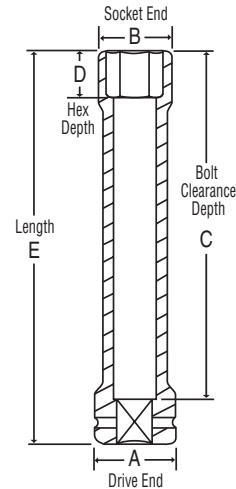

No. 40T20 1" Drive T-Handle Tool

This tool features a sliding drive head that allows for use in tight spaces. The head is held in place by a friction pin so it can slide flush with the ends of the bar. A Friction ball retainer holds sockets securely to the drive. When used as a breaker bar the 30" handle provides extra leverage.



Item Number	Drive Size	Dimensions (Inches)				
		A	B	C	D	E
40T20	1"	1.94	1.10	2.07	3.13	30.00

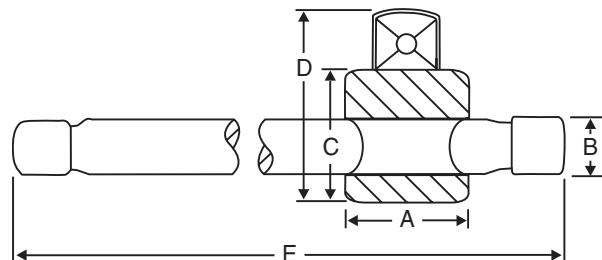



1" Drive Impact Attachments



1" Square Drive Adapters SAE

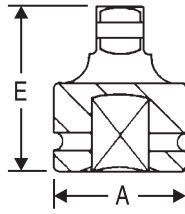

Item Number	Female End	Male End	Socket Retention Device	Dimensions (Inches)	
				A	E
*4008A	1"	3/4"	Pin Hole	2.13	2.95
*4008AB	1"	3/4"	Friction Ball	2.13	2.95
*4008AL	1"	3/4"	Locking Pin	2.13	2.95
4009A	1"	1-1/2"	Pin Hole	2.13	3.54

* Reducing Adapters are not covered by the GP Warranty.

* See page 182 for Reducing Sleeve Adapters

1" Square to #5 Spline Drive Adapter SAE

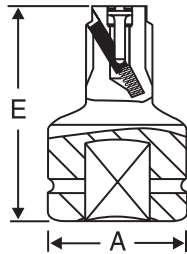

Item Number	Female End	Male End	Socket Retention Device	Dimensions (Inches)	
				A	E
4011A	1"	#5 Spline	Lock Button	2.20	4.14

5500RK Repair Kit for No. 3011A, No. 4011A & No. 6011A

1" Drive Universal Joints SAE



4006UJ



4006HUJ

The 4006UJ is a standard pin type universal. The 4006HUJ features a heavy-duty rotating ball U-joint for smoother operation and maximum durability under demanding conditions. The smooth operation also allows more torque to reach the fastener.

Item Number	Description	Socket Retention Device	Dimensions (Inches)	
			Diameter	Length
4006UJ	1" x 1"	Pin Hole	2.13	4.33
4006HUJ	1" x 1" Heavy Duty	Pin Hole	2.28	4.65

1" Drive Extensions SAE



7"



Item Number	Description	Socket Retention Device	Dimensions (Inches)	
			A	E
4003E	3" Extension	Pin Hole	2.13	2.95
4003EL	3" Extension	Locking Pin	2.13	2.95
4007E	7" Extension	Pin Hole	2.13	6.89
4007EL	7" Extension	Locking Pin	2.13	6.89
4010E	10" Extension	Pin Hole	2.13	9.84
4010EL	10" Extension	Locking Pin	2.13	9.84
4013E	13" Extension	Pin Hole	2.13	12.99
4013EL	13" Extension	Locking Pin	2.13	12.99

Socket Retention Device Key for 1" Drive Adapters, Extensions & Universal Joints



PH



FB



LP

PH Pin Hole

Uses Ret Ring® or Pin & O-ring to secure socket. The most secure system available. Recommended for 3/4" drive and larger impact wrenches.

FB Friction Ball

A spring loaded steel ball that lines up with the socket retainer hole. Use caution when using this system because the socket is held in place only by spring pressure on the steel ball.

LP Locking Pin

Spring loaded pin, simply line up with socket retainer hole and press pin. To release socket, insert object through retainer hole and press pin.

Do NOT run the tool when the socket is OFF the fastener.





Impact Socket O-Ring Retaining Rings

SAE MM



PINS

Item Number	Fits Socket Drive End Diameters	Pin Diameter	Pin Length
4520	1.89" - 2.24" (48mm - 57mm)	.20" (5mm)	1.70" (43mm)
4521	2.13" - 2.44" (54mm - 62mm)	.20" (5mm)	1.77" (45mm)
4523	3.39" (86mm)	.24" (6mm)	2.95" (75mm)
4524	3.74" (95mm)	.24" (6mm)	3.15" (80mm)
4525	5.00" (127mm)	.315" (8mm)	4.49" (114mm)
4526	5.98" (152mm)	.315" (8mm)	5.47" (139mm)

O-RINGS

Item Number	Fits Socket Drive End Diameters	O-Ring I.D.	O-Ring Thickness
4510	1.89" - 2.05" (48mm - 52mm)	1.59" (40mm)	.20" (5mm)
4511	2.13" - 2.28" (54mm - 58mm)	1.89" (48mm)	.20" (5mm)
4512	2.44" (62mm)	2.09" (53mm)	.20" (5mm)
4513	3.39" (86mm)	2.95" (75mm)	.24" (6mm)
4514	3.74" (95mm)	3.35" (85mm)	.24" (6mm)
4515	5.00" (127mm)	4.49" (114mm)	.276" (7mm)
4516	5.98" (152mm)	5.47" (139mm)	.276" (7mm)

Ret Ring® One-Piece Socket Retainers

SAE MM



The Ret Ring® connects an impact socket onto an impact wrench, extension, adapter or universal joint. One-piece, molded of new space age polyurethane, with a steel insert for added safety. Available for 3/4", 1" and 1-1/2" drive impact sockets. For a complete listing and cross-reference to other manufacturers part numbers see below.

Item Number	Square Drive Size	Fits Socket Ends "A" Diameters
3110	3/4"	1.50" (38mm)
3111	3/4"	1.65" - 1.77" (42mm - 44mm)
3112	3/4"	2.13" - 2.24" (54mm - 56mm)
4110	1"	2.01" - 2.13" (51mm - 54mm)
4111	1"	2.16" - 2.28" (55mm - 58mm)
4112	1"	2.30" - 2.44" (59mm - 62mm)
6110	1-1/2"	3.39" (86mm)
6111	1-1/2"	3.74" (95mm)

Complete Ret Ring® Listing and Cross Reference Guide



Step 1

Place Ret Ring® over impact square drive, put on impact socket aligning retention holes, then insert center-pin through retention holes.

Step 2

Push center-pin completely through hole.

Step 3

Pull O-ring up into groove on opposite side.

Do NOT run the tool when the socket is OFF the fastener.

Item Number	Drive Size	Ret Ring® I.D. (In.)	Wright Part No.	Proto Part No.	Armstrong Part No.
3110	3/4"	1.250	6580	-	21-964
3111	3/4"	1.438	6581	J07500-0	21-965
3112	3/4"	2.000	6582B	-	-
4110	1"	1.750	6583	J10000-3	22-964
4111	1"	2.000	6581A	J10000-1	-
4112	1"	2.125	6584	J10000-2	22-965
6110	1-1/2"	2.875	84575	J10000-4	23-964
6111	1-1/2"	3.375	84576	-	-





1-1/2" Drive Standard Length Impact Sockets



6 1-1/2" Drive - Standard Length - Fractional Sizes SAE

Item Number	Hex Size	Shape	*Retaining Devices			Dimensions (Inches)				
			P	O	RI	A	B	C	D	E
6044R	1-3/8"	I	4523	4513	6110	3.39	2.52	1.42	0.87	3.07
6046R	1-7/16"	I	4523	4513	6110	3.39	2.52	1.42	0.94	3.07
6048R	1-1/2"	I	4523	4513	6110	3.39	2.60	1.50	1.02	3.15
6050R	1-9/16"	I	4523	4513	6110	3.39	2.68	1.50	1.10	3.15
6052R	1-5/8"	I	4523	4513	6110	3.39	2.76	1.50	1.10	3.15
6054R	1-11/16"	I	4523	4513	6110	3.39	2.87	1.57	1.10	3.23
6056R	1-3/4"	I	4523	4513	6110	3.39	2.95	1.65	1.18	3.31
6058R	1-13/16"	I	4523	4513	6110	3.39	2.99	1.65	1.18	3.31
6060R	1-7/8"	I	4523	4513	6110	3.39	3.07	1.77	1.26	3.43
6062R	1-15/16"	I	4523	4513	6110	3.39	3.15	1.77	1.26	3.43
6064R	2"	I	4523	4513	6110	3.39	3.23	1.77	1.26	3.43
6066R	2-1/16"	I	4523	4513	6110	3.39	3.27	1.77	1.34	3.43
6068R	2-1/8"	II	4523	4513	6110	3.39	3.39	1.89	1.46	3.54
6070R	2-3/16"	III	4523	4513	6110	3.39	3.46	1.89	1.46	3.54
6072R	2-1/4"	III	4523	4513	6110	3.39	3.54	2.09	1.54	3.74
6074R	2-5/16"	III	4523	4513	6110	3.39	3.66	2.09	1.54	3.74
6076R	2-3/8"	III	4523	4513	6110	3.39	3.70	2.09	1.54	3.74
6078R	2-7/16"	III	4523	4513	6110	3.39	3.78	2.28	1.65	3.94
6080R	2-1/2"	III	4523	4513	6110	3.39	3.86	2.28	1.65	3.94
6082R	2-9/16"	III	4523	4513	6110	3.39	3.94	2.28	1.65	3.94
6084R	2-5/8"	III	4523	4513	6110	3.39	4.02	2.48	1.81	4.13
6086R	2-11/16"	III	4523	4513	6110	3.39	4.09	2.48	1.81	4.13
6088R	2-3/4"	III	4523	4513	6110	3.39	4.17	2.48	1.81	4.13
6090R	2-13/16"	III	4523	4513	6110	3.39	4.25	2.60	1.93	4.25
6092R	2-7/8"	III	4523	4513	6110	3.39	4.33	2.60	1.93	4.25
6094R	2-15/16"	III	4523	4513	6110	3.39	4.41	2.52	1.93	4.25
6096R	3"	III	4523	4513	6110	3.39	4.45	2.52	1.93	4.25
6098R	3-1/16"	III	4523	4513	6110	3.39	4.53	2.80	2.09	4.53
6100R	3-1/8"	III	4523	4513	6110	3.39	4.65	2.80	2.09	4.53
6102R	3-3/16"	III	4523	4513	6110	3.39	4.72	2.80	2.09	4.53
6104R	3-1/4"	III	4523	4513	6110	3.39	4.80	2.80	2.09	4.53
6106R	3-5/16"	III	4523	4513	6110	3.39	4.88	2.91	2.20	4.65
6108R	3-3/8"	III	4523	4513	6110	3.39	4.96	2.91	2.20	4.65
6110R	3-7/16"	III	4523	4513	6110	3.39	5.04	2.91	2.20	4.65
6112R	3-1/2"	III	4523	4513	6110	3.39	5.08	3.11	2.32	4.84
6114R	3-9/16"	III	4523	4513	6110	3.39	5.16	3.11	2.32	4.84
6116R	3-5/8"	III	4523	4513	6110	3.39	5.24	3.11	2.32	4.84
6118R	3-11/16"	III	4523	4513	6110	3.39	5.31	3.11	2.40	4.84
6120R	3-3/4"	III	4524	4514	6111	3.74	5.39	3.11	2.40	4.84
6122R	3-13/16"	III	4524	4514	6111	3.74	5.39	3.39	2.56	5.12
6124R	3-7/8"	III	4524	4514	6111	3.74	5.67	3.39	2.56	5.12
6126R	3-15/16"	III	4524	4514	6111	3.74	5.67	3.39	2.56	5.12
6128R	4"	III	4524	4514	6111	3.74	5.79	3.39	2.56	5.12
6130R	4-1/16"	III	4524	4514	6111	3.74	5.79	3.39	2.68	5.12
6132R	4-1/8"	III	4524	4514	6111	3.74	6.06	3.39	2.68	5.12
6134R	4-3/16"	III	4524	4514	6111	3.74	6.06	3.39	2.68	5.12
6136R	4-1/4"	III	4524	4514	6111	3.74	6.06	3.58	2.83	5.31
6138R	4-5/16"	III	4524	4514	6111	3.74	6.18	3.58	2.83	5.31
6140R	4-3/8"	III	4524	4514	6111	3.74	6.18	3.58	2.83	5.31
6142R	4-7/16"	III	4524	4514	6111	3.74	6.18	3.58	2.83	5.31
6144R	4-1/2"	III	4524	4514	6111	3.74	6.46	3.78	3.03	5.51
6148R	4-5/8"	III	4524	4514	6111	3.74	6.46	3.78	3.03	5.51
6152R	4-3/4"	III	4524	4514	6111	3.74	6.57	3.78	3.03	5.51
6156R	4-7/8"	III	4525	4515	-	5.00	6.85	3.78	3.03	5.51
6160R	5"	III	4525	4515	-	5.00	6.97	3.98	3.15	5.71
6164R	5-1/8"	III	4525	4515	-	5.00	7.24	3.98	3.15	5.71
6168R	5-1/4"	III	4525	4515	-	5.00	7.36	4.17	3.35	5.91
6172R	5-3/8"	III	4525	4515	-	5.00	7.64	4.17	3.35	5.91
6176R	5-1/2"	III	4525	4515	-	5.00	7.76	4.57	3.54	6.30
6180R	5-5/8"	III	4525	4515	-	5.00	8.03	4.65	3.54	6.30
6184R	5-3/4"	III	4525	4515	-	5.00	8.03	4.65	3.54	6.30
6188R	5-7/8"	III	4525	4515	-	5.00	8.15	4.65	3.54	6.30
6192R	6"	III	4525	4515	-	5.00	8.43	4.76	3.54	6.50
6196R	6-1/8"	III	4525	4515	-	5.00	8.54	4.84	3.54	6.50
6200R	6-1/4"	III	4525	4515	-	5.00	8.82	4.84	3.54	6.50
6204R	6-3/8"	III	4525	4515	-	5.00	8.94	4.84	3.74	6.50
6208R	6-1/2"	III	4525	4515	-	5.00	8.94	5.16	3.74	6.89

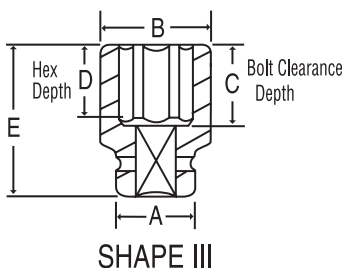

* Retaining Devices Key found on page 124.

WARNING: Always wear safety goggles when using Impact Tools. Use only properly matched fractional or metric sizes.



1-1/2" Drive Standard Length Impact Sockets



6 1-1/2" Drive - Standard Length - Metric Sizes MM



SHAPE I

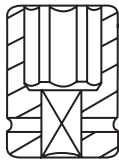

SHAPE II

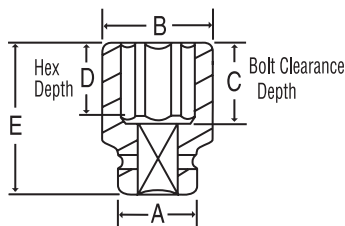

SHAPE III

Item Number	Hex Size	Shape	*Retaining Devices			Dimensions (Millimeters)				
			P	O	R1	A	B	C	D	E
6030M	30mm	I	4523	4513	6110	86	56	36	21	78
6032M	32mm	I	4523	4513	6110	86	58	36	22	78
6033M	33mm	I	4523	4513	6110	86	60	36	22	78
6034M	34mm	I	4523	4513	6110	86	61	36	22	78
6035M	35mm	I	4523	4513	6110	86	64	36	22	78
6036M	36mm	I	4523	4513	6110	86	64	36	24	78
6037M	37mm	I	4523	4513	6110	86	65	36	24	78
6038M	38mm	I	4523	4513	6110	86	66	38	26	80
6040M	40mm	I	4523	4513	6110	86	68	38	28	80
6041M	41mm	I	4523	4513	6110	86	70	38	28	80
6042M	42mm	I	4523	4513	6110	86	71	40	28	82
6043M	43mm	I	4523	4513	6110	86	73	40	28	82
6045M	45mm	I	4523	4513	6110	86	75	42	30	84
6046M	46mm	I	4523	4513	6110	86	76	42	30	84
6047M	47mm	I	4523	4513	6110	86	77	45	32	87
6048M	48mm	I	4523	4513	6110	86	79	45	32	87
6049M	49mm	I	4523	4513	6110	86	80	45	32	87
6050M	50mm	I	4523	4513	6110	86	81	45	32	87
6052M	52mm	I	4523	4513	6110	86	83	45	34	87
6054M	54mm	II	4523	4513	6110	86	86	48	37	90
6055M	55mm	III	4523	4513	6110	86	87	48	37	90
6056M	56mm	III	4523	4513	6110	86	88	50	37	92
6057M	57mm	III	4523	4513	6110	86	90	53	39	95
6058M	58mm	III	4523	4513	6110	86	92	53	39	95
6059M	59mm	III	4523	4513	6110	86	93	53	39	95
6060M	60mm	III	4523	4513	6110	86	94	53	39	95
6061M	61mm	III	4523	4513	6110	86	95	58	42	100
6062M	62mm	III	4523	4513	6110	86	96	58	42	100
6063M	63mm	III	4523	4513	6110	86	97	58	42	100
6065M	65mm	III	4523	4513	6110	86	100	58	42	100
6068M	68mm	III	4523	4513	6110	86	104	63	46	105
6070M	70mm	III	4523	4513	6110	86	106	63	46	105
6072M	72mm	III	4523	4513	6110	86	108	66	49	108
6073M	73mm	III	4523	4513	6110	86	110	66	49	108
6075M	75mm	III	4523	4513	6110	86	112	66	49	108
6076M	76mm	III	4523	4513	6110	86	113	66	49	108
6077M	77mm	III	4523	4513	6110	86	114	66	49	108
6078M	78mm	III	4523	4513	6110	86	115	73	53	115
6080M	80mm	III	4523	4513	6110	86	119	73	53	115
6085M	85mm	III	4523	4513	6110	86	125	76	56	118
6088M	88mm	III	4523	4513	6110	86	128	76	56	118
6090M	90mm	III	4523	4513	6110	86	131	81	59	123
6095M	95mm	III	4523	4513	6110	86	137	81	61	123
60100M	100mm	III	4523	4513	6110	86	144	88	65	130
60105M	105mm	III	4523	4513	6110	86	154	88	68	130
60110M	110mm	III	4523	4513	6110	86	157	93	72	135
60115M	115mm	III	4523	4513	6110	86	164	98	77	140
60120M	120mm	III	4523	4513	6110	86	167	98	77	140
60125M	125mm	III	4525	4515	-	127	174	98	77	140
60130M	130mm	III	4525	4515	-	127	184	103	80	145
60135M	135mm	III	4525	4515	-	127	194	108	85	150
60140M	140mm	III	4525	4515	-	127	197	118	90	160
60145M	145mm	III	4525	4515	-	127	204	118	90	160
60150M	150mm	III	4525	4515	-	127	207	123	90	165
60155M	155mm	III	4525	4515	-	127	214	123	90	165
60160M	160mm	III	4525	4515	-	127	224	128	90	170
60165M	165mm	III	4525	4515	-	127	227	133	95	175
60170M	170mm	III	4525	4515	-	127	234	138	95	180
60175M	175mm	III	4525	4515	-	127	244	143	100	185

* Retaining Devices Key found on page 124.



1-1/2" Drive Deep Length Impact Sockets



6 1-1/2" Drive - Deep Length - Fractional Sizes SAE



1-1/2"

Item Number	Hex Size	Shape	*Retaining Devices			Dimensions (Inches)				
			P	O	R1	A	B	C	D	E
6048D	1-1/2"	I	4523	4513	6110	3.39	2.60	2.87	1.02	4.53
6052D	1-5/8"	I	4523	4513	6110	3.39	2.76	2.87	1.10	4.53
6056D	1-3/4"	I	4523	4513	6110	3.39	2.95	2.87	1.18	4.53
6060D	1-7/8"	I	4523	4513	6110	3.39	3.07	2.87	1.26	4.53
6064D	2"	I	4523	4513	6110	3.39	3.23	3.66	1.34	5.31
6068D	2-1/8"	II	4523	4513	6110	3.39	3.39	3.86	1.46	5.51
6070D	2-3/16"	III	4523	4513	6110	3.39	3.46	3.86	1.46	5.51
6072D	2-1/4"	III	4523	4513	6110	3.39	3.54	4.25	1.54	5.91
6074D	2-5/16"	III	4523	4513	6110	3.39	3.66	4.25	1.54	5.91
6076D	2-3/8"	III	4523	4513	6110	3.39	3.70	4.25	1.54	5.91
6078D	2-7/16"	III	4523	4513	6110	3.39	3.78	4.25	1.65	5.91
6080D	2-1/2"	III	4523	4513	6110	3.39	3.86	4.25	1.65	5.91
6082D	2-9/16"	III	4523	4513	6110	3.39	3.94	4.25	1.65	5.91
6084D	2-5/8"	III	4523	4513	6110	3.39	4.02	4.25	1.81	5.91
6088D	2-3/4"	III	4523	4513	6110	3.39	4.17	4.65	1.81	6.30
6092D	2-7/8"	III	4523	4513	6110	3.39	4.33	4.65	1.93	6.30
6094D	2-15/16"	III	4523	4513	6110	3.39	4.41	4.96	1.93	6.69
6096D	3"	III	4523	4513	6110	3.39	4.45	4.96	1.93	6.69
6098D	3-1/16"	III	4523	4513	6110	3.39	4.53	4.96	2.09	6.69
6100D	3-1/8"	III	4523	4513	6110	3.39	4.65	4.96	2.09	6.69
6104D	3-1/4"	III	4523	4513	6110	3.39	4.80	4.96	2.09	6.69
6106D	3-5/16"	III	4523	4513	6110	3.39	4.88	4.96	2.20	6.69
6108D	3-3/8"	III	4523	4513	6110	3.39	4.96	4.96	2.20	6.69
6112D	3-1/2"	III	4523	4513	6110	3.39	5.08	4.96	2.32	6.69
6116D	3-5/8"	III	4523	4513	6110	3.39	5.24	4.96	2.32	6.69
6120D	3-3/4"	III	4524	4514	6111	3.74	5.39	5.35	2.40	7.09
6128D	4"	III	4524	4514	6111	3.74	5.79	5.75	2.56	7.48
6132D	4-1/8"	III	4524	4514	6111	3.74	6.06	5.75	2.68	7.48
6136D	4-1/4"	III	4524	4514	6111	3.74	6.06	5.75	2.83	7.48
6144D	4-1/2"	III	4524	4514	6111	3.74	6.46	6.54	3.03	8.27
6148D	4-5/8"	III	4524	4514	6111	3.74	6.46	6.54	3.03	8.27
6152D	4-3/4"	III	4524	4514	6111	3.74	6.57	6.54	3.03	8.27

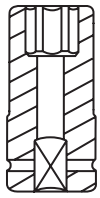

SHAPE I

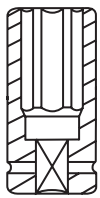

SHAPE II

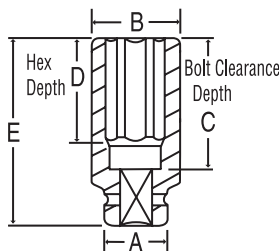

SHAPE III

Retaining Devices Key



Pin and O-Ring

One Piece



1-1/2" Drive Deep Length Impact Sockets



6 1-1/2" Drive - Deep Length - Metric Sizes ▲ MM

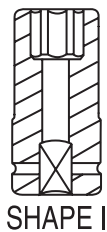

SHAPE I

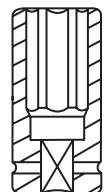

SHAPE II

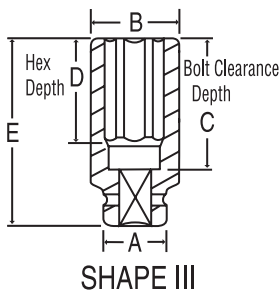

SHAPE III

Item Number	Hex Size	Shape	*Retaining Devices			Dimensions (Millimeters)				
			P	O	R1	A	B	C	D	E
6030MD	30mm	I	4523	4513	6110	86	56	73	21	115
6032MD	32mm	I	4523	4513	6110	86	58	73	22	115
6033MD	33mm	I	4523	4513	6110	86	60	73	22	115
6034MD	34mm	I	4523	4513	6110	86	61	73	22	115
6035MD	35mm	I	4523	4513	6110	86	64	73	22	115
6036MD	36mm	I	4523	4513	6110	86	64	73	24	115
6037MD	37mm	I	4523	4513	6110	86	65	73	24	115
6038MD	38mm	I	4523	4513	6110	86	66	73	26	115
6040MD	40mm	I	4523	4513	6110	86	68	73	28	115
6041MD	41mm	I	4523	4513	6110	86	70	73	28	115
6042MD	42mm	I	4523	4513	6110	86	71	73	28	115
6043MD	43mm	I	4523	4513	6110	86	73	73	28	115
6045MD	45mm	I	4523	4513	6110	86	75	73	30	115
6046MD	46mm	I	4523	4513	6110	86	76	73	30	115
6047MD	47mm	I	4523	4513	6110	86	77	73	32	115
6048MD	48mm	I	4523	4513	6110	86	79	73	32	115
6049MD	49mm	I	4523	4513	6110	86	80	73	32	115
6050MD	50mm	I	4523	4513	6110	86	81	93	34	135
6052MD	52mm	I	4523	4513	6110	86	83	98	34	140
6054MD	54mm	II	4523	4513	6110	86	86	98	37	140
6055MD	55mm	III	4523	4513	6110	86	87	98	37	140
6056MD	56mm	III	4523	4513	6110	86	88	98	37	140
6057MD	57mm	III	4523	4513	6110	86	90	108	39	150
6058MD	58mm	III	4523	4513	6110	86	92	108	39	150
6059MD	59mm	III	4523	4513	6110	86	93	108	39	150
6060MD	60mm	III	4523	4513	6110	86	94	108	39	150
6061MD	61mm	III	4523	4513	6110	86	95	108	39	150
6062MD	62mm	III	4523	4513	6110	86	96	108	42	150
6063MD	63mm	III	4523	4513	6110	86	97	108	42	150
6065MD	65mm	III	4523	4513	6110	86	100	108	42	150
6068MD	68mm	III	4523	4513	6110	86	104	108	46	150
6070MD	70mm	III	4523	4513	6110	86	106	118	46	160
6072MD	72mm	III	4523	4513	6110	86	108	118	49	160
6073MD	73mm	III	4523	4513	6110	86	110	118	49	160
6075MD	75mm	III	4523	4513	6110	86	112	128	49	170
6076MD	76mm	III	4523	4513	6110	86	113	128	49	170
6077MD	77mm	III	4523	4513	6110	86	114	128	53	170
6078MD	78mm	III	4523	4513	6110	86	115	128	53	170
6080MD	80mm	III	4523	4513	6110	86	119	128	53	170
6085MD	85mm	III	4523	4513	6110	86	125	128	56	170
6088MD	88mm	III	4523	4513	6110	86	128	128	56	170
6090MD	90mm	III	4523	4513	6110	86	131	128	59	170
6095MD	95mm	III	4524	4514	6111	95	137	138	61	180
60100MD	100mm	III	4524	4514	6111	95	144	148	65	190
60105MD	105mm	III	4524	4514	6111	95	154	148	68	190
60110MD	110mm	III	4524	4514	6111	95	157	158	72	200
60115MD	115mm	III	4524	4514	6111	95	164	168	77	210
60120MD	120mm	III	4524	4514	6111	95	167	168	77	210
60125MD	125mm	III	4525	4515	-	127	174	168	77	210

1-1/2"

Retaining Devices Key



Pin and O-Ring

One Piece



1-1/2" Drive 12-Point Standard Length Impact Sockets



12 1-1/2" Drive 12-Point - Standard Length - Fractional Sizes SAE



1-1/2"

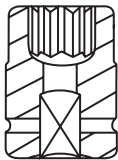

SHAPE I

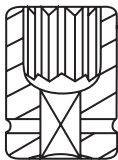

SHAPE II

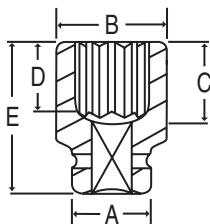

SHAPE III

Item Number	12-Point Size	Shape	*Retaining Devices			Dimensions (Inches)				
			P	O	R1	A	B	C	D	E
6238R	1-3/16"	I	4523	4513	6110	3.39	2.20	1.42	0.83	3.07
6240R	1-1/4"	I	4523	4513	6110	3.39	2.28	1.42	0.87	3.07
6242R	1-5/16"	I	4523	4513	6110	3.39	2.36	1.42	0.87	3.07
6244R	1-3/8"	I	4523	4513	6110	3.39	2.52	1.42	0.87	3.07
6246R	1-7/16"	I	4523	4513	6110	3.39	2.52	1.42	0.94	3.07
6248R	1-1/2"	I	4523	4513	6110	3.39	2.60	1.50	1.02	3.15
6250R	1-9/16"	I	4523	4513	6110	3.39	2.68	1.50	1.10	3.15
6252R	1-5/8"	I	4523	4513	6110	3.39	2.76	1.50	1.10	3.15
6254R	1-11/16"	I	4523	4513	6110	3.39	2.87	1.57	1.10	3.23
6256R	1-3/4"	I	4523	4513	6110	3.39	2.95	1.65	1.18	3.31
6258R	1-13/16"	I	4523	4513	6110	3.39	2.99	1.65	1.18	3.31
6260R	1-7/8"	I	4523	4513	6110	3.39	3.07	1.77	1.26	3.43
6262R	1-15/16"	I	4523	4513	6110	3.39	3.15	1.77	1.26	3.43
6264R	2"	I	4523	4513	6110	3.39	3.23	1.77	1.26	3.43
6266R	2-1/16"	I	4523	4513	6110	3.39	3.27	1.77	1.34	3.43
6268R	2-1/8"	II	4523	4513	6110	3.39	3.39	1.89	1.46	3.54
6270R	2-3/16"	III	4523	4513	6110	3.39	3.46	1.89	1.46	3.54
6272R	2-1/4"	III	4523	4513	6110	3.39	3.54	2.09	1.54	3.74
6274R	2-5/16"	III	4523	4513	6110	3.39	3.66	2.09	1.54	3.74
6276R	2-3/8"	III	4523	4513	6110	3.39	3.70	2.09	1.54	3.74
6278R	2-7/16"	III	4523	4513	6110	3.39	3.78	2.28	1.65	3.94
6280R	2-1/2"	III	4523	4513	6110	3.39	3.86	2.28	1.65	3.94
6282R	2-9/16"	III	4523	4513	6110	3.39	3.94	2.28	1.65	3.94
6284R	2-5/8"	III	4523	4513	6110	3.39	4.02	2.48	1.81	4.13
6286R	2-11/16"	III	4523	4513	6110	3.39	4.09	2.48	1.81	4.13
6288R	2-3/4"	III	4523	4513	6110	3.39	4.17	2.48	1.81	4.13
6290R	2-13/16"	III	4523	4513	6110	3.39	4.25	2.60	1.93	4.25
6292R	2-7/8"	III	4523	4513	6110	3.39	4.33	2.60	1.93	4.25
6294R	2-15/16"	III	4523	4513	6110	3.39	4.41	2.60	1.93	4.25
6296R	3"	III	4523	4513	6110	3.39	4.45	2.60	1.93	4.25
6298R	3-1/16"	III	4523	4513	6110	3.39	4.53	2.87	2.09	4.53
6300R	3-1/8"	III	4523	4513	6110	3.39	4.65	2.87	2.09	4.53
6302R	3-3/16"	III	4523	4513	6110	3.39	4.72	2.87	2.09	4.53
6304R	3-1/4"	III	4523	4513	6110	3.39	4.80	2.87	2.09	4.53
6306R	3-5/16"	III	4523	4513	6110	3.39	4.88	2.99	2.20	4.65
6308R	3-3/8"	III	4523	4513	6110	3.39	4.96	2.99	2.20	4.65
6310R	3-7/16"	III	4523	4513	6110	3.39	5.04	2.99	2.20	4.65
6312R	3-1/2"	III	4523	4513	6110	3.39	5.08	3.19	2.32	4.84
6314R	3-9/16"	III	4523	4513	6110	3.39	5.16	3.19	2.32	4.84
6316R	3-5/8"	III	4523	4513	6110	3.39	5.24	3.19	2.32	4.84
6318R	3-11/16"	III	4523	4513	6110	3.39	5.31	3.19	2.40	4.84
6320R	3-3/4"	III	4524	4514	6111	3.74	5.39	3.19	2.40	4.84
6322R	3-13/16"	III	4524	4514	6111	3.74	5.39	3.46	2.56	5.12
6324R	3-7/8"	III	4524	4514	6111	3.74	5.67	3.46	2.56	5.12
6326R	3-15/16"	III	4524	4514	6111	3.74	5.67	3.46	2.56	5.12
6328R	4"	III	4524	4514	6111	3.74	5.79	3.46	2.56	5.12
6330R	4-1/16"	III	4524	4514	6111	3.74	5.79	3.46	2.68	5.12
6332R	4-1/8"	III	4524	4514	6111	3.74	6.06	3.46	2.68	5.12
6334R	4-3/16"	III	4524	4514	6111	3.74	6.06	3.46	2.68	5.12
6336R	4-1/4"	III	4524	4514	6111	3.74	6.06	3.66	2.83	5.31
6338R	4-5/16"	III	4524	4514	6111	3.74	6.18	3.66	2.83	5.31
6340R	4-3/8"	III	4524	4514	6111	3.74	6.18	3.66	2.83	5.31
6342R	4-7/16"	III	4524	4514	6111	3.74	6.18	3.66	2.83	5.31
6344R	4-1/2"	III	4524	4514	6111	3.74	6.46	3.86	3.03	5.51
6348R	4-5/8"	III	4524	4514	6111	3.74	6.46	3.86	3.03	5.51
6352R	4-3/4"	III	4524	4514	6111	3.74	6.57	3.86	3.03	5.51
6356R	4-7/8"	III	4525	4515	-	5.00	6.85	3.86	3.03	5.51
6360R	5"	III	4525	4515	-	5.00	6.97	4.06	3.15	5.71
6364R	5-1/8"	III	4525	4515	-	5.00	7.24	4.06	3.15	5.71
6368R	5-1/4"	III	4525	4515	-	5.00	7.36	4.25	3.35	5.91
6372R	5-3/8"	III	4525	4515	-	5.00	7.64	4.25	3.35	5.91
6376R	5-1/2"	III	4525	4515	-	5.00	7.76	4.65	3.54	6.30
6380R	5-5/8"	III	4525	4515	-	5.00	8.03	4.65	3.54	6.30
6384R	5-3/4"	III	4525	4515	-	5.00	8.03	4.65	3.54	6.30
6388R	5-7/8"	III	4525	4515	-	5.00	8.15	4.84	3.54	6.50
6392R	6"	III	4525	4515	-	5.00	8.43	4.84	3.54	6.50
6396R	6-1/8"	III	4525	4515	-	5.00	8.43	4.84	3.54	6.50
6400R	6-1/4"	III	4525	4515	-	5.00	8.82	5.04	3.54	6.69
6404R	6-3/8"	III	4525	4515	-	5.00	8.82	5.04	3.54	6.69
6408R	6-1/2"	III	4525	4515	-	5.00	8.94	5.24	3.74	6.89

* Retaining Devices Key found on page 125.



1-1/2" Drive 12-Point Standard Length Impact Sockets



12 1-1/2" Drive 12-Point - Standard Length - Metric Sizes MM

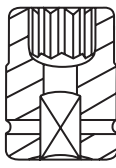

SHAPE I

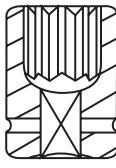

SHAPE II

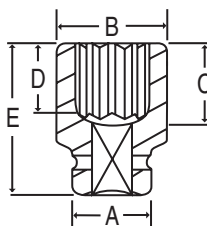

SHAPE III

Item Number	12-Point Size	Shape	*Retaining Devices			Dimensions (Millimeters)				
			P	O	RI	A	B	C	D	E
6230M	30mm	I	4523	4513	6110	86	56	36	21	78
6232M	32mm	I	4523	4513	6110	86	58	36	22	78
6233M	33mm	I	4523	4513	6110	86	60	36	22	78
6234M	34mm	I	4523	4513	6110	86	61	36	22	78
6235M	35mm	I	4523	4513	6110	86	64	36	22	78
6236M	36mm	I	4523	4513	6110	86	64	36	24	78
6237M	37mm	I	4523	4513	6110	86	65	36	24	78
6238M	38mm	I	4523	4513	6110	86	66	38	26	80
6240M	40mm	I	4523	4513	6110	86	68	38	28	80
6241M	41mm	I	4523	4513	6110	86	70	38	28	80
6242M	42mm	I	4523	4513	6110	86	71	40	28	82
6243M	43mm	I	4523	4513	6110	86	73	40	28	82
6245M	45mm	I	4523	4513	6110	86	75	42	30	84
6246M	46mm	I	4523	4513	6110	86	76	42	30	84
6247M	47mm	I	4523	4513	6110	86	77	45	32	87
6248M	48mm	I	4523	4513	6110	86	79	45	32	87
6249M	49mm	I	4523	4513	6110	86	80	45	32	87
6250M	50mm	I	4523	4513	6110	86	81	45	32	87
6252M	52mm	I	4523	4513	6110	86	83	45	34	87
6254M	54mm	II	4523	4513	6110	86	86	48	37	90
6255M	55mm	III	4523	4513	6110	86	87	48	37	90
6256M	56mm	III	4523	4513	6110	86	88	50	37	92
6257M	57mm	III	4523	4513	6110	86	90	53	39	95
6258M	58mm	III	4523	4513	6110	86	92	53	39	95
6259M	59mm	III	4523	4513	6110	86	93	53	39	95
6260M	60mm	III	4523	4513	6110	86	94	53	39	95
6261M	61mm	III	4523	4513	6110	86	95	58	42	100
6262M	62mm	III	4523	4513	6110	86	96	58	42	100
6263M	63mm	III	4523	4513	6110	86	97	58	42	100
6265M	65mm	III	4523	4513	6110	86	100	58	42	100
6268M	68mm	III	4523	4513	6110	86	104	63	46	105
6270M	70mm	III	4523	4513	6110	86	106	63	46	105
6272M	72mm	III	4523	4513	6110	86	108	66	49	108
6273M	73mm	III	4523	4513	6110	86	110	66	49	108
6275M	75mm	III	4523	4513	6110	86	112	66	49	108
6276M	76mm	III	4523	4513	6110	86	113	66	49	108
6277M	77mm	III	4523	4513	6110	86	114	66	49	108
6278M	78mm	III	4523	4513	6110	86	115	73	53	115
6280M	80mm	III	4523	4513	6110	86	119	73	53	115
6285M	85mm	III	4523	4513	6110	86	125	76	56	118
6288M	88mm	III	4523	4513	6110	86	128	76	56	118
6290M	90mm	III	4523	4513	6110	86	131	81	59	123
6295M	95mm	III	4524	4514	6111	95	137	81	61	123
62100M	100mm	III	4524	4514	6111	95	144	88	65	130
62105M	105mm	III	4524	4514	6111	95	154	88	68	130
62110M	110mm	III	4524	4514	6111	95	157	93	72	135
62115M	115mm	III	4524	4514	6111	95	164	98	77	140
62120M	120mm	III	4524	4514	6111	95	167	98	77	140
62125M	125mm	III	4525	4516	-	127	174	98	80	140
62130M	130mm	III	4525	4516	-	127	184	103	85	145
62135M	135mm	III	4525	4516	-	127	194	108	90	150
62140M	140mm	III	4525	4516	-	127	197	118	90	160
62145M	145mm	III	4525	4516	-	127	204	118	90	160
62150M	150mm	III	4525	4516	-	127	207	123	90	165
62155M	155mm	III	4525	4516	-	127	214	123	90	165
62160M	160mm	III	4525	4516	-	127	224	128	90	170
62165M	165mm	III	4525	4516	-	127	227	133	95	175
62170M	170mm	III	4525	4516	-	127	234	138	95	180
62175M	175mm	III	4525	4516	-	127	244	143	100	185

* Retaining Devices Key found on page 125.



1-1/2" Drive 12-Point Deep Length Impact Sockets



12 1-1/2" Drive 12-Point - Deep Length - Fractional Sizes SAE



1-1/2"

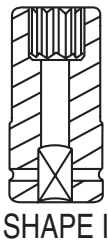

SHAPE I

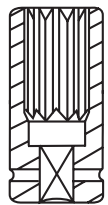

SHAPE II

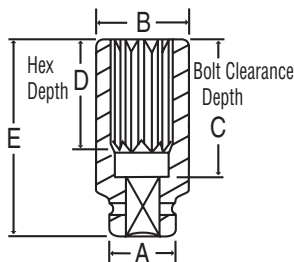

SHAPE III

Item Number	12-Point Size	Shape	*Retaining Devices			Dimensions (Inches)				
			P	O	R1	A	B	C	D	E
6238D	1-3/16"	I	4523	4513	6110	3.39	2.20	2.87	0.83	4.53
6240D	1-1/4"	I	4523	4513	6110	3.39	2.28	2.87	0.87	4.53
6242D	1-5/16"	I	4523	4513	6110	3.39	2.36	2.87	0.87	4.53
6244D	1-3/8"	I	4523	4513	6110	3.39	2.52	2.87	0.87	4.53
6246D	1-7/16"	I	4523	4513	6110	3.39	2.52	2.87	0.94	4.53
6248D	1-1/2"	I	4523	4513	6110	3.39	2.60	2.87	1.02	4.53
6250D	1-9/16"	I	4523	4513	6110	3.39	2.68	2.87	1.10	4.53
6252D	1-5/8"	I	4523	4513	6110	3.39	2.76	2.87	1.10	4.53
6254D	1-11/16"	I	4523	4513	6110	3.39	2.87	2.87	1.10	4.53
6256D	1-3/4"	I	4523	4513	6110	3.39	2.95	2.87	1.18	4.53
6258D	1-13/16"	I	4523	4513	6110	3.39	2.99	2.87	1.18	4.53
6260D	1-7/8"	I	4523	4513	6110	3.39	3.07	2.87	1.26	4.53
6262D	1-15/16"	I	4523	4513	6110	3.39	3.15	2.87	1.26	4.53
6264D	2"	I	4523	4513	6110	3.39	3.23	3.66	1.34	5.31
6266D	2-1/16"	I	4523	4513	6110	3.39	3.27	3.86	1.34	5.51
6268D	2-1/8"	II	4523	4513	6110	3.39	3.39	3.86	1.46	5.51
6270D	2-3/16"	III	4523	4513	6110	3.39	3.46	3.86	1.46	5.51
6272D	2-1/4"	III	4523	4513	6110	3.39	3.54	4.25	1.54	5.91
6274D	2-5/16"	III	4523	4513	6110	3.39	3.66	4.25	1.54	5.91
6276D	2-3/8"	III	4523	4513	6110	3.39	3.70	4.25	1.54	5.91
6278D	2-7/16"	III	4523	4513	6110	3.39	3.78	4.25	1.65	5.91
6280D	2-1/2"	III	4523	4513	6110	3.39	3.86	4.25	1.65	5.91
6282D	2-9/16"	III	4523	4513	6110	3.39	3.94	4.25	1.65	5.91
6284D	2-5/8"	III	4523	4513	6110	3.39	4.02	4.25	1.81	5.91
6286D	2-11/16"	III	4523	4513	6110	3.39	4.09	4.25	1.81	5.91
6288D	2-3/4"	III	4523	4513	6110	3.39	4.17	4.65	1.81	6.30
6290D	2-13/16"	III	4523	4513	6110	3.39	4.25	4.65	1.93	6.30
6292D	2-7/8"	III	4523	4513	6110	3.39	4.33	4.65	1.93	6.30
6294D	2-15/16"	III	4523	4513	6110	3.39	4.41	5.04	1.93	6.69
6296D	3"	III	4523	4513	6110	3.39	4.45	5.04	1.93	6.69
6298D	3-1/16"	III	4523	4513	6110	3.39	4.53	5.04	2.09	6.69
6300D	3-1/8"	III	4523	4513	6110	3.39	4.65	5.04	2.09	6.69
6302D	3-3/16"	III	4523	4513	6110	3.39	4.72	5.04	2.09	6.69
6304D	3-1/4"	III	4523	4513	6110	3.39	4.80	5.04	2.09	6.69
6306D	3-5/16"	III	4523	4513	6110	3.39	4.88	5.04	2.20	6.69
6308D	3-3/8"	III	4523	4513	6110	3.39	4.96	5.04	2.20	6.69
6310D	3-7/16"	III	4523	4513	6110	3.39	5.04	5.04	2.20	6.69
6312D	3-1/2"	III	4523	4513	6110	3.39	5.08	5.04	2.32	6.69
6314D	3-9/16"	III	4523	4513	6110	3.39	5.16	5.04	2.32	6.69
6316D	3-5/8"	III	4523	4513	6110	3.39	5.24	5.04	2.32	6.69
6318D	3-11/16"	III	4523	4513	6110	3.39	5.31	5.04	2.40	6.69
6320D	3-3/4"	III	4524	4514	6111	3.74	5.39	5.43	2.40	7.09
6322D	3-13/16"	III	4524	4514	6111	3.74	5.39	5.43	2.56	7.09
6324D	3-7/8"	III	4524	4514	6111	3.74	5.67	5.43	2.56	7.09
6326D	3-15/16"	III	4524	4514	6111	3.74	5.67	5.83	2.56	7.48
6328D	4"	III	4524	4514	6111	3.74	5.79	5.83	2.56	7.48
6330D	4-1/16"	III	4524	4514	6111	3.74	5.79	5.83	2.68	7.48
6332D	4-1/8"	III	4524	4514	6111	3.74	6.06	5.83	2.68	7.48
6334D	4-3/16"	III	4524	4514	6111	3.74	6.06	5.83	2.68	7.48
6336D	4-1/4"	III	4524	4514	6111	3.74	6.06	5.83	2.83	7.48
6338D	4-5/16"	III	4524	4514	6111	3.74	6.18	6.22	2.83	7.87
6340D	4-3/8"	III	4524	4514	6111	3.74	6.18	6.22	2.83	7.87
6342D	4-7/16"	III	4524	4514	6111	3.74	6.18	6.22	2.83	7.87
6344D	4-1/2"	III	4524	4514	6111	3.74	6.46	6.61	3.03	8.27
6348D	4-5/8"	III	4524	4514	6111	3.74	6.46	6.61	3.03	8.27
6352D	4-3/4"	III	4524	4514	6111	3.74	6.57	6.61	3.03	8.27

* Retaining Devices Key found on page 129.



1-1/2" Drive 12-Point Deep Length Impact Sockets



12 1-1/2" Drive 12-Point - Deep Length - Metric Sizes



50 mm

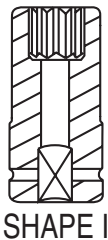

SHAPE I

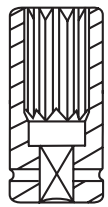

SHAPE II

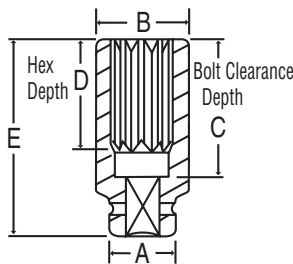

SHAPE III

Item Number	12-Point Size	Shape	*Retaining Devices			Dimensions (Millimeters)				
			P	O	R1	A	B	C	D	E
6230MD	30mm	I	4523	4513	6110	86	56	73	21	115
6232MD	32mm	I	4523	4513	6110	86	58	73	22	115
6233MD	33mm	I	4523	4513	6110	86	60	73	22	115
6234MD	34mm	I	4523	4513	6110	86	61	73	22	115
6235MD	35mm	I	4523	4513	6110	86	64	73	22	115
6236MD	36mm	I	4523	4513	6110	86	64	73	24	115
6237MD	37mm	I	4523	4513	6110	86	65	73	24	115
6238MD	38mm	I	4523	4513	6110	86	66	73	26	115
6240MD	40mm	I	4523	4513	6110	86	68	73	28	115
6241MD	41mm	I	4523	4513	6110	86	70	73	28	115
6242MD	42mm	I	4523	4513	6110	86	71	73	28	115
6243MD	43mm	I	4523	4513	6110	86	73	73	28	115
6245MD	45mm	I	4523	4513	6110	86	75	73	30	115
6246MD	46mm	I	4523	4513	6110	86	76	73	30	115
6247MD	47mm	I	4523	4513	6110	86	77	73	32	115
6248MD	48mm	I	4523	4513	6110	86	79	73	32	115
6249MD	49mm	I	4523	4513	6110	86	80	73	32	115
6250MD	50mm	I	4523	4513	6110	86	81	93	34	135
6252MD	52mm	I	4523	4513	6110	86	83	98	34	140
6254MD	54mm	II	4523	4513	6110	86	86	98	37	140
6255MD	55mm	III	4523	4513	6110	86	87	98	37	140
6256MD	56mm	III	4523	4513	6110	86	88	98	37	140
6257MD	57mm	III	4523	4513	6110	86	90	108	39	150
6258MD	58mm	III	4523	4513	6110	86	92	108	39	150
6259MD	59mm	III	4523	4513	6110	86	93	108	39	150
6260MD	60mm	III	4523	4513	6110	86	94	108	39	150
6261MD	61mm	III	4523	4513	6110	86	95	108	42	150
6262MD	62mm	III	4523	4513	6110	86	96	108	42	150
6263MD	63mm	III	4523	4513	6110	86	97	108	42	150
6265MD	65mm	III	4523	4513	6110	86	100	108	42	150
6268MD	68mm	III	4523	4513	6110	86	104	108	46	150
6270MD	70mm	III	4523	4513	6110	86	106	118	46	160
6272MD	72mm	III	4523	4513	6110	86	108	118	49	160
6273MD	73mm	III	4523	4513	6110	86	110	118	49	160
6275MD	75mm	III	4523	4513	6110	86	112	128	49	170
6276MD	76mm	III	4523	4513	6110	86	113	128	49	170
6277MD	77mm	III	4523	4513	6110	86	114	128	53	170
6278MD	78mm	III	4523	4513	6110	86	115	128	53	170
6280MD	80mm	III	4523	4513	6110	86	119	128	53	170
6285MD	85mm	III	4523	4513	6110	86	125	128	56	170
6288MD	88mm	III	4523	4513	6110	86	128	128	56	170
6290MD	90mm	III	4523	4513	6110	86	131	128	59	170
6295MD	95mm	III	4524	4514	6111	95	137	138	61	180
62100MD	100mm	III	4524	4514	6111	95	144	148	65	190
62105MD	105mm	III	4524	4514	6111	95	154	148	68	190
62110MD	110mm	III	4524	4514	6111	95	157	158	72	200
62115MD	115mm	III	4524	4514	6111	95	164	168	77	210
62120MD	120mm	III	4524	4514	6111	95	167	168	77	210
62125MD	125mm	III	4525	4516	-	127	174	168	77	210

1-1/2"

Retaining Devices Key

P 	O 	R1
Pin and O-Ring		One Piece



1-1/2" Drive Impact Attachments



1-1/2" Drive Adapters SAE

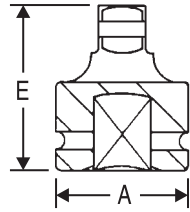

Item Number	Female End	Male End	Socket Retention Device	Dimensions (Inches)	
				A	E
*6008A	1-1/2"	1"	Pin Hole	3.39	3.94
6009A	1-1/2"	2-1/2"	Pin Hole	3.39	4.72

* Reducing Adapters are not covered by the GP Warranty.
* See page 182 for Reducing Sleeve Adapters

1-1/2" Square to #5 Spline Drive Adapter SAE

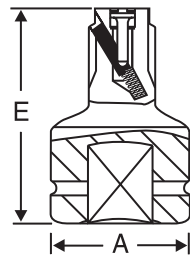

Item Number	Female End	Male End	Socket Retention Device	Dimensions (Inches)	
				A	E
6011A	1-1/2"	#5 Spline	Lock Button	3.39	4.92

5500RK Repair Kit for No. 3011A, No. 4011A & No. 6011A

1-1/2" Drive Universal Joint SAE

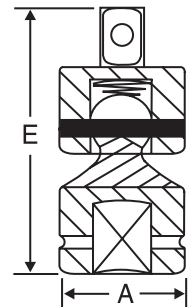

Item Number	Description	Socket Retention Device	Dimensions (Inches)	
			A	E
6006UJ	1-1/2" x 1-1/2"	Pin Hole	3.39	7.17

1-1/2" Drive Extensions SAE



Item Number	Description	Socket Retention Device	Dimensions (Inches)	
			A	E
6005E	5" Extension	Pin Hole	3.39	4.92
6010E	10" Extension	Pin Hole	3.39	9.84
6020E	20" Extension	Pin Hole	3.39	19.69

Socket Retention Device Key for 1-1/2" Drive Adapters, Extensions & Universal Joints



PH Pin Hole

Uses Ret Ring® or Pin & O-ring to secure socket. The most secure system available. Recommended for 3/4" drive and larger impact wrenches.

LB Lock Button

Spring loaded locking device on Spline to secure socket. Socket is released by inserting object through socket face and depressing release button.

Do NOT run the tool when the socket is OFF the fastener.



2-1/2" Drive Fractional Impact Sockets



6 2-1/2" Drive - Standard Length - Fractional Sizes SAE



SHAPE I

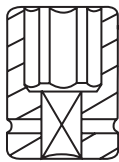

SHAPE II

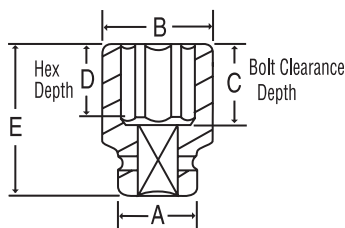



SHAPE III

Item Number	Hex Size	Shape	*Retaining Devices			Dimensions (Inches)				
			P	O	R1	A	B	C	D	E
7096R	3"	I	4525	4515	-	5.00	4.72	3.15	1.77	5.51
7100R	3-1/8"	I	4525	4515	-	5.00	4.88	3.15	1.77	5.51
7104R	3-1/4"	II	4525	4515	-	5.00	5.00	3.15	1.77	5.51
7108R	3-3/8"	III	4525	4515	-	5.00	5.16	2.95	2.05	5.51
7112R	3-1/2"	III	4525	4515	-	5.00	5.31	2.95	2.05	5.51
7116R	3-5/8"	III	4525	4515	-	5.00	5.47	3.15	2.05	5.71
7120R	3-3/4"	III	4525	4515	-	5.00	5.63	3.15	2.05	5.71
7124R	3-7/8"	III	4525	4515	-	5.00	5.79	3.35	2.28	5.91
7128R	4"	III	4525	4515	-	5.00	5.94	3.35	2.28	5.91
7132R	4-1/8"	III	4525	4515	-	5.00	6.10	3.54	2.28	6.10
7136R	4-1/4"	III	4525	4515	-	5.00	6.26	3.74	2.36	6.30
7140R	4-3/8"	III	4525	4515	-	5.00	6.42	3.94	2.44	6.50
7144R	4-1/2"	III	4525	4515	-	5.00	6.57	3.94	2.44	6.50
7148R	4-5/8"	III	4525	4515	-	5.00	6.77	4.13	2.64	6.69
7152R	4-3/4"	III	4525	4515	-	5.00	6.93	4.13	2.64	6.69
7156R	4-7/8"	III	4525	4515	-	5.00	7.24	4.33	2.83	6.89
7160R	5"	III	4525	4515	-	5.00	7.24	4.33	2.83	6.89
7164R	5-1/8"	III	4526	4516	-	5.98	7.36	4.33	2.83	6.89
7168R	5-1/4"	III	4526	4516	-	5.98	7.64	4.33	2.83	6.89
7172R	5-3/8"	III	4526	4516	-	5.98	7.76	4.53	3.03	7.09
7176R	5-1/2"	III	4526	4516	-	5.98	8.03	4.53	3.03	7.09
7180R	5-5/8"	III	4526	4516	-	5.98	8.15	4.72	3.27	7.28
7184R	5-3/4"	III	4526	4516	-	5.98	8.43	4.72	3.27	7.28
7188R	5-7/8"	III	4526	4516	-	5.98	8.43	4.72	3.27	7.28
7192R	6"	III	4526	4516	-	5.98	8.54	4.72	3.27	7.28
7196R	6-1/8"	III	4526	4516	-	5.98	8.82	4.92	3.54	7.48
7200R	6-1/4"	III	4526	4516	-	5.98	8.94	4.92	3.54	7.48
7204R	6-3/8"	III	4526	4516	-	5.98	9.21	5.12	3.74	7.68
7208R	6-1/2"	III	4526	4516	-	5.98	9.21	5.12	3.74	7.68
7212R	6-5/8"	III	4526	4516	-	5.98	9.33	5.12	3.74	7.68
7216R	6-3/4"	III	4526	4516	-	5.98	9.61	5.12	3.74	7.68
7220R	6-7/8"	III	4526	4516	-	5.98	9.72	5.31	3.94	7.87
7224R	7"	III	4526	4516	-	5.98	10.00	5.31	3.94	7.87
7240R	7-1/2"	III	4526	4516	-	5.98	10.39	5.71	4.13	8.27
7244R	7-5/8"	III	4526	4516	-	5.98	10.51	5.71	4.13	8.27
7256R	8"	III	4526	4516	-	5.98	10.91	6.10	4.33	8.66

2-1/2"

Retaining Devices Key

P 	O 	R1 
Pin and O-Ring		One Piece



2-1/2" Drive Metric Impact Sockets



⑥ 2-1/2" Drive - Standard Length - Metric Sizes ▲ MM



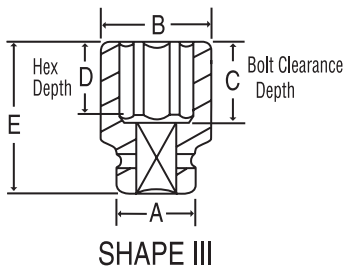

2-1/2"

Item Number	Hex Size	Shape	*Retaining Devices			Dimensions (Millimeters)				
			P	O	R1	A	B	C	D	E
7077M	77mm	I	4525	4515	-	127	122	80	45	140
7080M	80mm	I	4525	4515	-	127	124	80	45	140
7085M	85mm	III	4525	4515	-	127	130	80	52	140
7090M	90mm	III	4525	4515	-	127	136	85	52	145
7095M	95mm	III	4525	4515	-	127	143	85	52	145
70100M	100mm	III	4525	4515	-	127	149	90	58	150
70105M	105mm	III	4525	4515	-	127	155	95	58	155
70110M	110mm	III	4525	4515	-	127	161	100	60	160
70115M	115mm	III	4525	4515	-	127	167	105	62	165
70120M	120mm	III	4525	4515	-	127	176	110	67	170
70125M	125mm	III	4525	4515	-	127	184	115	72	175
70130M	130mm	III	4526	4516	-	152	187	115	72	175
70135M	135mm	III	4526	4516	-	152	194	120	77	180
70140M	140mm	III	4526	4516	-	152	204	120	77	180
70145M	145mm	III	4526	4516	-	152	207	125	83	185
70150M	150mm	III	4526	4516	-	152	214	125	83	185
70155M	155mm	III	4526	4516	-	152	224	130	90	190
70160M	160mm	III	4526	4516	-	152	227	130	90	190
70165M	165mm	III	4526	4516	-	152	234	135	95	195
70170M	170mm	III	4526	4516	-	152	244	135	95	195
70175M	175mm	III	4526	4516	-	152	247	140	100	200
70180M	180mm	III	4526	4516	-	152	254	140	100	200
70185M	185mm	III	4526	4516	-	152	257	150	105	210
70190M	190mm	III	4526	4516	-	152	264	150	105	210
70200M	200mm	III	4526	4516	-	152	274	160	110	220
70210M	210mm	III	4526	4516	-	152	287	160	110	220



Retaining Devices Key

P 	O 	R1 
Pin and O-Ring		One Piece



2-1/2" Drive 12-Point Fractional Impact Sockets



12 2-1/2" Drive 12-Point - Standard Length - Fractional Sizes SAE

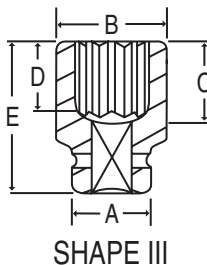

Item Number	12-Point Size	Shape	*Retaining Devices			Dimensions (Inches)				
			P	O	R1	A	B	C	D	E
7396R	3"	I	4525	4515	-	5.00	4.72	3.15	1.77	5.51
7400R	3-1/8"	I	4525	4515	-	5.00	4.88	3.15	1.77	5.51
7404R	3-1/4"	II	4525	4515	-	5.00	5.00	3.15	1.77	5.51
7408R	3-3/8"	III	4525	4515	-	5.00	5.16	3.15	2.05	5.51
7410R	3-7/16"	III	4525	4515	-	5.00	5.24	3.15	2.05	5.51
7412R	3-1/2"	III	4525	4515	-	5.00	5.31	3.15	2.05	5.51
7416R	3-5/8"	III	4525	4515	-	5.00	5.47	3.35	2.05	5.71
7420R	3-3/4"	III	4525	4515	-	5.00	5.63	3.35	2.05	5.71
7424R	3-7/8"	III	4525	4515	-	5.00	5.79	3.54	2.28	5.91
7428R	4"	III	4525	4515	-	5.00	5.94	3.54	2.28	5.91
7432R	4-1/8"	III	4525	4515	-	5.00	6.10	3.74	2.28	6.10
7436R	4-1/4"	III	4525	4515	-	5.00	6.26	3.94	2.36	6.30
7440R	4-3/8"	III	4525	4515	-	5.00	6.42	4.13	2.44	6.50
7444R	4-1/2"	III	4525	4515	-	5.00	6.57	4.13	2.44	6.50
7448R	4-5/8"	III	4525	4515	-	5.00	6.77	4.33	2.64	6.69
7452R	4-3/4"	III	4525	4515	-	5.00	6.93	4.33	2.64	6.69
7456R	4-7/8"	III	4525	4515	-	5.00	7.24	4.53	2.83	6.89
7460R	5"	III	4525	4515	-	5.00	7.24	4.53	2.83	6.89
7464R	5-1/8"	III	4526	4516	-	5.98	7.36	4.53	2.83	6.89
7468R	5-1/4"	III	4526	4516	-	5.98	7.64	4.53	2.83	6.89
7472R	5-3/8"	III	4526	4516	-	5.98	7.76	4.72	3.03	7.09
7476R	5-1/2"	III	4526	4516	-	5.98	8.03	4.72	3.03	7.09
7480R	5-5/8"	III	4526	4516	-	5.98	8.15	4.92	3.27	7.28
7484R	5-3/4"	III	4526	4516	-	5.98	8.43	4.92	3.27	7.28
7488R	5-7/8"	III	4526	4516	-	5.98	8.43	4.92	3.27	7.28
7492R	6"	III	4526	4516	-	5.98	8.54	4.92	3.27	7.28
7496R	6-1/8"	III	4526	4516	-	5.98	8.82	5.12	3.54	7.48
7500R	6-1/4"	III	4526	4516	-	5.98	8.94	5.12	3.54	7.48
7504R	6-3/8"	III	4526	4516	-	5.98	9.21	5.31	3.74	7.68
7508R	6-1/2"	III	4526	4516	-	5.98	9.21	5.31	3.74	7.68
7512R	6-5/8"	III	4526	4516	-	5.98	9.33	5.31	3.74	7.68
7516R	6-3/4"	III	4526	4516	-	5.98	9.61	5.31	3.74	7.68
7520R	6-7/8"	III	4526	4516	-	5.98	9.72	5.51	3.94	7.87
7524R	7"	III	4526	4516	-	5.98	10.00	5.51	3.94	7.87
7528R	7-1/8"	III	4526	4516	-	5.98	10.00	5.91	4.13	8.27
7540R	7-1/2"	III	4526	4516	-	5.98	10.39	5.91	4.13	8.27
7544R	7-5/8"	III	4526	4516	-	5.98	10.51	5.91	4.13	8.27
7548R	7-7/8"	III	4526	4516	-	5.98	10.79	6.30	4.33	8.66
7556R	8"	III	4526	4516	-	5.98	10.91	6.30	4.33	8.66

2-1/2"

Retaining Devices Key

P 	O 	R1 
Pin and O-Ring		One Piece



2-1/2" Drive 12-Point Metric Impact Sockets



12 2-1/2" Drive 12-Point - Standard Length - Metric Sizes MM



2-1/2"

Item Number	12-Point Size	Shape	*Retaining Devices			Dimensions (Millimeters)				
			P	O	R1	A	B	C	D	E
7277M	77mm	I	4525	4515	-	127	122	80	45	140
7280M	80mm	I	4525	4515	-	127	124	80	45	140
7285M	85mm	III	4525	4515	-	127	130	80	52	140
7290M	90mm	III	4525	4515	-	127	136	85	52	145
7295M	95mm	III	4525	4515	-	127	143	85	52	145
72100M	100mm	III	4525	4515	-	127	149	90	58	150
72105M	105mm	III	4525	4515	-	127	155	95	58	155
72110M	110mm	III	4525	4515	-	127	161	100	60	160
72115M	115mm	III	4525	4515	-	127	167	105	62	165
72120M	120mm	III	4525	4515	-	127	176	110	67	170
72125M	125mm	III	4525	4515	-	127	184	115	72	175
72130M	130mm	III	4526	4516	-	152	187	115	72	175
72135M	135mm	III	4526	4516	-	152	194	120	77	180
72140M	140mm	III	4526	4516	-	152	204	120	77	180
72145M	145mm	III	4526	4516	-	152	207	125	83	185
72150M	150mm	III	4526	4516	-	152	214	125	83	185
72155M	155mm	III	4526	4516	-	152	224	130	90	190
72160M	160mm	III	4526	4516	-	152	227	130	90	190
72165M	165mm	III	4526	4516	-	152	234	135	95	195
72170M	170mm	III	4526	4516	-	152	244	135	95	195
72175M	175mm	III	4526	4516	-	152	247	140	100	200
72180M	180mm	III	4526	4516	-	152	254	140	100	200
72185M	185mm	III	4526	4516	-	152	257	150	105	210
72190M	190mm	III	4526	4516	-	152	264	150	105	210
72200M	200mm	III	4526	4516	-	152	274	160	110	220
72210M	210mm	III	4526	4516	-	152	287	160	110	220

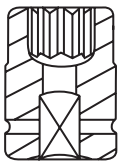

SHAPE I

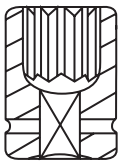

SHAPE II

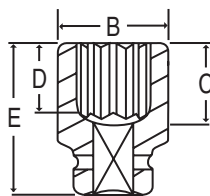

SHAPE III

Retaining Devices Key





2-1/2" Drive Impact Attachments



2-1/2" Drive Adapter SAE

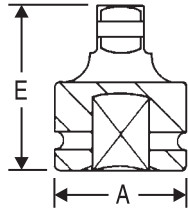

Item Number	Female End	Male End	Socket Retention Device	Dimensions (Inches)	
				A	E
*7008A	2-1/2"	1-1/2"	Pin Hole	5.00	5.43

* Reducing Adapters are not covered by the GP Warranty.
* See page 182 for Reducing Sleeve Adapters

2-1/2" Drive Extensions SAE

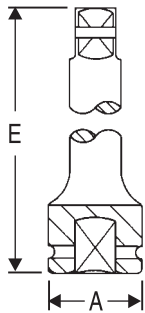

Item Number	Description	Socket Retention Device	Dimensions (Inches)	
			A	E
7005E	5" Extension	Pin Hole	5.00	4.92
7010E	10" Extension	Pin Hole	5.00	9.84
7020E	20" Extension	Pin Hole	5.00	19.96

2-1/2"

2-1/2" Drive Socket O-Rings & Retaining Pins SAE MM



PINS

Item Number	Fits Socket Drive End Diameters	Pin Diameter	Pin Length
4525	5.00 (127mm)	.315	4.49
4526	5.98 (152mm)	.315	5.47



O-RINGS

Item Number	Fits Socket Drive End Diameters	O-Ring I.D.	O-Ring Thickness
4515	5.00 (127mm)	4.49	.276
4516	5.98 (152mm)	5.47	.276

Socket Retention Device Key for 2-1/2" Drive Adapters & Extensions



PH Pin Hole

Uses Ret Ring® or Pin & O-ring to secure socket. The most secure system available. Recommended for 3/4" drive and larger impact wrenches.

Do NOT run the tool when the socket is OFF the fastener.



#5 Spline Drive Impact Sockets



6 No. 9260 #5 Spline Drive Truck Wheel Set SAE MM

A special #5 spline drive set designed for servicing truck wheels. It contains a 13/16" square size for the budd wheel inner cap nuts, a 1-1/2" outer budd nut size that has a "controlled depth" hex end to help prevent contact with the wheel, a 33mm size for 10 hole hub piloted wheels, three (3) deep thin wall sizes, and other regular length impact sockets.



10 piece set contents:

- | | |
|----------------------------------|------------------------------|
| 5313S 13/16" Square | 5034DT . . 1-1/16" T.W. Deep |
| 5028R 7/8" Standard | 5036DT . . 1-1/8" T.W. Deep |
| 5030R 15/16" Standard | 5040DT . . 1-1/4" T.W. Deep |
| 5032R 1" Standard | 5048DB . . 1-1/2" Deep Budd |
| 5038R 1-3/16" Standard | Metal Storage Case |
| 5033M 33mm Standard | |

6 No. 9263 #5 Spline Drive Truck Wheel Fractional & Metric Socket Set SAE MM

Ten (10) of the most popular fractional and metric impact socket sizes for truck wheel fasteners.



10 piece set contents:

- | | |
|--------------------------------|-----------------------------|
| 5034DT . . . 1-1/16" T.W. Deep | 5041MDT . 41mm Deep T.W. |
| 5036DT . . . 1-1/8" T.W. Deep | 5313S 13/16" Square |
| 5040DT . . . 1-1/4" T.W. Deep | 5317S 17mm Square |
| 5048DB . . . 1-1/2" Deep Budd | 5321S 21mm Square |
| 5033MD 33mm Deep | Metal Storage Case |
| 5035MDT . . . 35mm Deep T.W. | |

6 #5 Spline Drive Deep Sockets SAE MM

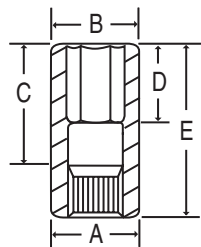

Item Number	Hex Size	Dimensions (Inches/Millimeters)				
		A	B	C	D	E
5033MD	33mm	55	55	78	54	108
5036MD	36mm	57	57	78	54	108
5046D	1-7/16"	2.36	2.36	3.07	1.02	4.25
5048DS	1-1/2"	2.36	2.36	2.87	1.97	4.06
5052D	1-5/8"	2.28	2.48	3.15	1.57	4.33
5056D	1-3/4"	2.36	2.68	4.13	2.17	5.31

6 #5 Spline Drive Budd Wheel Socket - 1-1/2" Limited Hex SAE

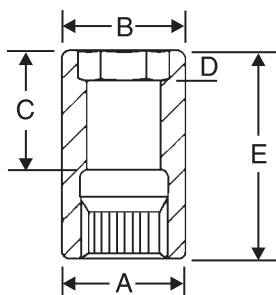

Special 1-1/2" hex deep heavy duty impact socket designed for outer cap nuts on budd-style truck wheels. The 1-1/2" hex depth is limited to help prevent socket contact with the wheel. The socket is deep style to eliminate contact with the inner cap nut.

Item Number	Hex Size	Dimensions (Inches)				
		A	B	C	D	E
5048DB	1-1/2"	2.36	2.36	2.83	.55	4.02



#5 Spline Drive Impact Sockets



6 #5 Spline - Standard Length - Fractional Sizes SAE

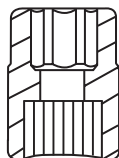

SHAPE I

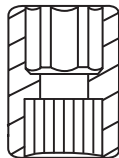

SHAPE II

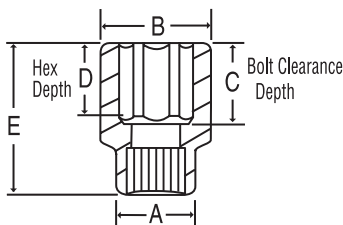

SHAPE III

Item Number	Hex Size	Shape	Dimensions (Inches)				
			A	B	C	D	E
5028R	7/8"	I	2.17	1.73	1.97	.94	3.15
5030R	15/16"	I	2.17	1.73	1.97	.94	3.15
5032R	1"	I	2.17	1.81	1.97	.94	3.15
5034R	1-1/16"	I	2.17	1.89	1.97	.94	3.15
5036R	1-1/8"	I	2.17	1.89	1.97	.94	3.15
5038R	1-3/16"	I	2.17	2.01	1.97	.94	3.15
5040R	1-1/4"	II	2.17	2.17	1.97	.94	3.15
5042R	1-5/16"	II	2.17	2.17	1.97	.94	3.15
5044R	1-3/8"	III	2.17	2.24	1.97	.94	3.15
5046R	1-7/16"	III	2.17	2.36	1.97	.94	3.15
5048R	1-1/2"	III	2.17	2.36	1.97	.94	3.15
5050R	1-9/16"	III	2.17	2.64	1.97	.94	3.15
5052R	1-5/8"	III	2.17	2.64	1.97	.94	3.15
5054R	1-11/16"	III	2.17	2.64	1.97	1.18	3.15
5056R	1-3/4"	III	2.56	2.87	2.68	1.50	3.86
5058R	1-13/16"	III	2.56	2.87	2.68	1.50	3.86
5060R	1-7/8"	III	2.56	2.87	2.68	1.50	3.86
5062R	1-15/16"	III	2.56	2.87	2.68	1.50	3.86
5064R	2"	III	2.56	3.11	2.68	1.50	3.86
5066R	2-1/16"	III	2.56	3.11	2.68	1.50	3.86
5068R	2-1/8"	III	2.56	3.11	2.68	1.50	3.86
5070R	2-3/16"	III	2.56	3.27	2.68	1.50	3.86
5072R	2-1/4"	III	2.56	3.39	2.99	1.81	4.17
5074R	2-5/16"	III	2.56	3.39	2.99	1.81	4.17
5076R	2-3/8"	III	2.56	3.39	2.99	1.81	4.17
5078R	2-7/16"	III	2.56	3.39	3.43	1.81	4.61
5080R	2-1/2"	III	3.39	3.90	3.43	2.24	4.61
5082R	2-9/16"	III	3.39	3.90	3.43	2.24	4.61
5084R	2-5/8"	III	3.39	3.90	3.43	2.24	4.61
5088R	2-3/4"	III	3.39	3.90	3.43	2.24	4.61
5094R	2-15/16"	III	3.39	4.13	3.43	2.24	4.61
5096R	3"	III	3.39	4.37	4.13	2.95	5.31
5100R	3-1/8"	III	3.39	4.37	4.13	2.95	5.31

#5 Spline

6 Standard Length - Metric Sizes MM

Item Number	Hex Size	Shape	Dimensions (Millimeters)				
			A	B	C	D	E
5022M	22mm	I	55	44	50	24	80
5024M	24mm	I	55	44	50	24	80
5025M	25mm	I	55	46	50	24	80
5027M	27mm	I	55	48	50	24	80
5029M	29mm	I	55	48	50	24	80
5030M	30mm	I	55	51	50	24	80
5032M	32mm	II	55	55	50	24	80
5033M	33mm	II	55	55	50	24	80
5035M	35mm	III	55	57	50	24	80
5038M	38mm	III	55	60	50	24	80
5040M	40mm	III	55	67	50	24	80
5041M	41mm	III	55	67	50	24	80



#5 Spline Drive Impact Sockets



6 #5 Spline Drive Combination Budd Wheel Sockets SAE MM

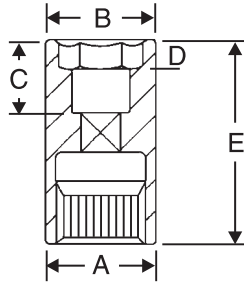

Removes and installs budd-type wheel fasteners. Sockets have two openings, eliminating the need for two separate sockets.

Item Number	Hex Size	Square Size	Dimensions (Inches/Millimeters)				
			A	B	C	D	E
5223C	1-1/2"	13/16"	2.28	2.28	3.07	.55	4.25
5241MC	41mm	21mm	58	58	78	14	108

6 #5 Spline Drive Deep Thin-Wall Sockets SAE MM

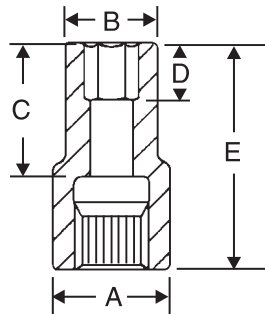

Designed for truck wheel service. For lug nuts that are deeply recessed and where space is very limited.

Item Number	Hex Size	Dimensions (Inches/Millimeters)				
		A	B	C	D	E
5034DT	1-1/16"	2.13	1.67	2.99	.98	4.17
5036DT	1-1/8"	2.13	1.69	2.99	.98	4.17
5040DT	1-1/4"	2.13	1.85	2.99	.98	4.17
5042DT	1-5/16"	2.13	1.93	2.99	.98	4.17
5048DT	1-1/2"	2.13	2.13	3.07	.98	4.25
5035MDT	35mm	54	51	78	25	108
5041MDT	41mm	57	57	78	25	108

4 #5 Spline Drive 4-Point (Square) Sockets SAE MM

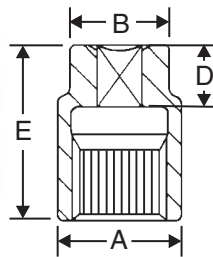

Item Number	Square Size	Dimensions (Inches/Millimeters)			
		A	B	D	E
5313S	13/16"	2.17	1.73	.94	2.68
5315S	15/16"	2.17	1.73	.94	2.68
5317S	17mm	55	52	24	77
5321S	21mm	55	52	24	77

4 #5 Spline Drive 4-Point (Square) Heavy Duty Socket SAE

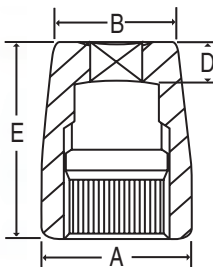

Item Number	Square Size	Dimensions (Inches)			
		A	B	D	E
5313SHD	13/16"	2.36	1.89	.67	3.07



#5 Spline Drive Impact Attachments



#5 Spline Drive Universal Joint SAE

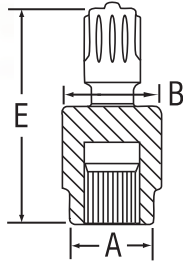

Item Number	Description	Socket Retention Device	Dimensions (Inches)		
			A	B	E
5006UJ	#5 Spl. x #5 Spl.	Lock Button	2.44	2.87	7.28

#5 Spline Drive Adapters SAE

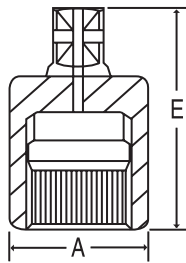

Item Number	Female End	Male End	Socket Retention Device	Dimensions (Inches)	
				A	E
*5008A	#5 Spline	3/4"	Pin Hole	2.09	3.43
*5008AB	#5 Spline	3/4"	Friction Ball	2.09	3.43
*5009A	#5 Spline	1"	Pin Hole	2.09	3.70
*5009AB	#5 Spline	1"	Friction Ball	2.09	3.70

Caution: Do not use Friction Ball Adapters with industrial anvils, extensions or universal joints with lock button socket retention devices.

*#5 Spline Drive Reducing Adapters are not covered by the GP Warranty.

#5 Spline Drive Adapters SAE

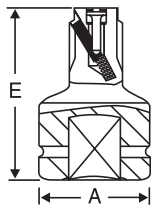

Item Number	Female End	Male End	Socket Retention Device	Dimensions (Inches)	
				A	E
3011A	3/4" Square	#5 Spline	Lock Button	2.13	4.13
4011A	1" Square	#5 Spline	Lock Button	2.20	4.14
6011A	1-1/2" Square	#5 Spline	Lock Button	3.39	4.92

5500RK Repair Kit for No. 3011A, No. 4011A & No. 6011A

#5 Spline Drive Extensions SAE



Item Number	Description	Socket Retention Device	Dimensions (Inches)	
			A	E
5508E	8" Extension	Lock Button	2.32	7.87
5515E	15" Extension	Lock Button	2.32	14.96

5500RK Repair Kit for No. 5508E, No. 5515E, No. 3011A, No. 4011A & No. 6011A

Socket Retention Device Key for #5 Spline Adapters, Extensions & Universal Joints

PH



FB



LB



PH Pin Hole

Uses Ret Ring® or Pin & O-ring to secure socket. The most secure system available. Recommended for 3/4" drive and larger impact wrenches.

FB Friction Ball

A spring loaded steel ball that lines up with the socket retainer hole. Use caution when using this system because the socket is held in place only by spring pressure on the steel ball.

LB Lock Button

Spring loaded locking device on Spline to secure socket. Socket is released by inserting object through socket face and depressing release button.

Do NOT run the tool when the socket is OFF the fastener.



1/4" Drive Duo-Socket® Master Sets



6 No. 89653CRD 1/4" Drive 6-Point Standard & Deep Length Fractional & Metric Set SAE MM



53 piece set contents:

- 10 Pieces Fractional Standard Length:**
3/16", 7/32", 1/4", 9/32", 5/16", 11/32", 3/8", 7/16",
1/2", 9/16"
- 10 Pieces Fractional Deep Length:**
3/16", 7/32", 1/4", 9/32", 5/16", 11/32", 3/8", 7/16",
1/2", 9/16"
- 14 Pieces Metric Standard Length:**
4mm, 4.5mm, 5mm, 5.5mm, 6mm, 7mm, 8mm,
9mm, 10mm, 11mm, 12mm, 13mm, 14mm, 15mm
- 14 Pieces Metric Deep Length:**
4mm, 4.5mm, 5mm, 5.5mm, 6mm, 7mm, 8mm,
9mm, 10mm, 11mm, 12mm, 13mm, 14mm, 15mm
- 1 Piece Each:**
72 Tooth Quick Release Ratchet - 5.5" L
2" Extension
4" Extension
6" Extension
Spinner Handle
Molded Storage Case

DUO

12 No. 89253CRD 1/4" Drive 12-Point Standard & Deep Length Fractional & Metric Set SAE MM



53 piece set contents:

- 10 Pieces Fractional Standard Length:**
3/16", 7/32", 1/4", 9/32", 5/16", 11/32", 3/8", 7/16",
1/2", 9/16"
- 10 Pieces Fractional Deep Length:**
3/16", 7/32", 1/4", 9/32", 5/16", 11/32", 3/8", 7/16",
1/2", 9/16"
- 14 Pieces Metric Standard Length:**
4mm, 4.5mm, 5mm, 5.5mm, 6mm, 7mm, 8mm,
9mm, 10mm, 11mm, 12mm, 13mm, 14mm, 15mm
- 14 Pieces Metric Deep Length:**
4mm, 4.5mm, 5mm, 5.5mm, 6mm, 7mm, 8mm,
9mm, 10mm, 11mm, 12mm, 13mm, 14mm, 15mm
- 1 Piece Each:**
72 Tooth Quick Release Ratchet - 5.5" L
2" Extension
4" Extension
6" Extension
Spinner Handle
Molded Storage Case



3/8" Drive 6-Point Duo-Socket® Master Set



6 No. 81659CRD 3/8" Drive 6-Point Standard & Deep Length Fractional & Metric Set



DUO

59 piece set contents:

12 Pieces Fractional Standard Length:

5/16", 3/8", 7/16", 1/2", 9/16", 5/8", 11/16", 3/4", 13/16", 7/8", 15/16", 1"

12 Pieces Fractional Deep Length:

5/16", 3/8", 7/16", 1/2", 9/16", 5/8", 11/16", 3/4", 13/16", 7/8", 15/16", 1"

16 Pieces Metric Standard Length:

7mm, 8mm, 9mm, 10mm, 11mm, 12mm, 13mm, 14mm, 15mm, 16mm, 17mm, 18mm, 19mm, 20mm, 21mm, 22mm

16 Pieces Metric Deep Length:

7mm, 8mm, 9mm, 10mm, 11mm, 12mm, 13mm, 14mm, 15mm, 16mm, 17mm, 18mm, 19mm, 20mm, 21mm, 22mm

1 Piece Each:

72 Tooth Quick Release Ratchet - 8" L
3" Extension
6" Extension

Molded Storage Case



3/8" Drive 6-Point Duo-Socket® Sets



6 No. 81627RD 3/8" Drive 6-Point Standard & Deep Length Fractional Set SAE



27 piece set contents:

12 Pieces Fractional Standard Length:

5/16", 3/8", 7/16", 1/2", 9/16", 5/8", 11/16", 3/4", 13/16", 7/8", 15/16", 1"

12 Pieces Fractional Deep Length:

5/16", 3/8", 7/16", 1/2", 9/16", 5/8", 11/16", 3/4", 13/16", 7/8", 15/16", 1"

1 Piece Each:

72 Tooth Quick Release Ratchet - 8" L
3" Extension
6" Extension

Molded Storage Case

DUO

6 No. 81635MRD 3/8" Drive 6-Point Standard & Deep Length Metric Set MM



35 piece set contents:

16 Pieces Metric Standard Length:

7mm, 8mm, 9mm, 10mm, 11mm, 12mm, 13mm, 14mm, 15mm, 16mm, 17mm, 18mm, 19mm, 20mm, 21mm, 22mm

16 Pieces Metric Deep Length:

7mm, 8mm, 9mm, 10mm, 11mm, 12mm, 13mm, 14mm, 15mm, 16mm, 17mm, 18mm, 19mm, 20mm, 21mm, 22mm

1 Piece Each:

72 Tooth Quick Release Ratchet - 8" L
3" Extension
6" Extension

Molded Storage Case



3/8" Drive 12-Point Duo-Socket® Master Set



12 No. 81259CRD 3/8" Drive 12-Point Standard & Deep Length Fractional & Metric Set **SAE** **MM**



DUO

59 piece set contents:

12 Pieces Fractional Standard Length:

5/16", 3/8", 7/16", 1/2", 9/16", 5/8", 11/16", 3/4", 13/16", 7/8", 15/16", 1"

12 Pieces Fractional Deep Length:

5/16", 3/8", 7/16", 1/2", 9/16", 5/8", 11/16", 3/4", 13/16", 7/8", 15/16", 1"

16 Pieces Metric Standard Length:

7mm, 8mm, 9mm, 10mm, 11mm, 12mm, 13mm, 14mm, 15mm, 16mm, 17mm, 18mm, 19mm, 20mm, 21mm, 22mm

16 Pieces Metric Deep Length:

7mm, 8mm, 9mm, 10mm, 11mm, 12mm, 13mm, 14mm, 15mm, 16mm, 17mm, 18mm, 19mm, 20mm, 21mm, 22mm

1 Piece Each:

72 Tooth Quick Release Ratchet - 8" L
3" Extension
6" Extension

Molded Storage Case



1/2" Drive 6-Point Fractional Duo-Socket® Sets



6 No. 82622 1/2" Drive 6-Point Standard Length Fractional Set SAE



22 piece set contents:

19 Pieces Fractional Standard Length:

3/8", 7/16", 1/2", 9/16", 5/8", 11/16", 3/4", 13/16",
7/8", 15/16", 1", 1-1/16", 1-1/8", 1-3/16", 1-1/4",
1-5/16", 1-3/8", 1-7/16", 1-1/2"

1 Piece Each:

24 Tooth Quick Release Ratchet - 10" L
3" Extension
6" Extension

Molded Storage Case

DUO

6 No. 82622D 1/2" Drive 6-Point Deep Length Fractional Set SAE



22 piece set contents:

19 Pieces Fractional Deep Length:

3/8", 7/16", 1/2", 9/16", 5/8", 11/16", 3/4", 13/16",
7/8", 15/16", 1", 1-1/16", 1-1/8", 1-3/16", 1-1/4",
1-5/16", 1-3/8", 1-7/16", 1-1/2"

1 Piece Each:

24 Tooth Quick Release Ratchet - 10" L
3" Extension
6" Extension

Molded Storage Case



1/2" Drive 6-Point Metric Duo-Socket® Sets



6 No. 82629M 1/2" Drive 6-Point Standard Length Metric Set MM



29 piece set contents:

26 Pieces Metric Standard Length:

10mm, 11mm, 12mm, 13mm, 14mm, 15mm, 16mm, 17mm, 18mm, 19mm, 20mm, 21mm, 22mm, 23mm, 24mm, 25mm, 26mm, 27mm, 28mm, 29mm, 30mm, 32mm, 33mm, 34mm, 35mm, 36mm

1 Piece Each:

24 Tooth Quick Release Ratchet - 10" L
3" Extension
6" Extension

Molded Storage Case

6 No. 82629MD 1/2" Drive 6-Point Deep Length Metric Set MM



29 piece set contents:

26 Pieces Metric Deep Length:

10mm, 11mm, 12mm, 13mm, 14mm, 15mm, 16mm, 17mm, 18mm, 19mm, 20mm, 21mm, 22mm, 23mm, 24mm, 25mm, 26mm, 27mm, 28mm, 29mm, 30mm, 32mm, 33mm, 34mm, 35mm, 36mm

1 Piece Each:

24 Tooth Quick Release Ratchet - 10" L
3" Extension
6" Extension

Molded Storage Case

DUO



1/2" Drive 12-Point Fractional Duo-Socket® Sets



12

No. 82222

1/2" Drive 12-Point Standard Length Fractional Set

SAE



22 piece set contents:

19 Pieces Fractional Standard Length:

3/8", 7/16", 1/2", 9/16", 5/8", 11/16", 3/4", 13/16",
7/8", 15/16", 1", 1-1/16", 1-1/8", 1-3/16", 1-1/4",
1-5/16", 1-3/8", 1-7/16", 1-1/2"

1 Piece Each:

24 Tooth Quick Release Ratchet - 10" L

3" Extension

6" Extension

Molded Storage Case

DUO

12

No. 82222D

1/2" Drive 12-Point Deep Length Fractional Set

SAE



22 piece set contents:

19 Pieces Fractional Deep Length:

3/8", 7/16", 1/2", 9/16", 5/8", 11/16", 3/4", 13/16",
7/8", 15/16", 1", 1-1/16", 1-1/8", 1-3/16", 1-1/4",
1-5/16", 1-3/8", 1-7/16", 1-1/2"

1 Piece Each:

24 Tooth Quick Release Ratchet - 10" L

3" Extension

6" Extension

Molded Storage Case





1/2" Drive 12-Point Metric Duo-Socket® Sets



No. 82229M

1/2" Drive 12-Point Standard Length Metric Set



29 piece set contents:

26 Pieces Metric Standard Length:

- 10mm, 11mm, 12mm, 13mm, 14mm, 15mm, 16mm, 17mm, 18mm, 19mm, 20mm, 21mm, 22mm, 23mm, 24mm, 25mm, 26mm, 27mm, 28mm, 29mm, 30mm, 32mm, 33mm, 34mm, 35mm, 36mm

1 Piece Each:

- 24 Tooth Quick Release Ratchet - 10" L
- 3" Extension
- 6" Extension

Molded Storage Case

DUO



No. 82229MD

1/2" Drive 12-Point Deep Length Metric Set



29 piece set contents:

26 Pieces Metric Deep Length:

- 10mm, 11mm, 12mm, 13mm, 14mm, 15mm, 16mm, 17mm, 18mm, 19mm, 20mm, 21mm, 22mm, 23mm, 24mm, 25mm, 26mm, 27mm, 28mm, 29mm, 30mm, 32mm, 33mm, 34mm, 35mm, 36mm

1 Piece Each:

- 24 Tooth Quick Release Ratchet - 10" L
- 3" Extension
- 6" Extension

Molded Storage Case





The GP Precision Drive Ratchet provides unmatched smooth performance and durability. The ergonomically designed handle adds comfort to all working conditions.

Quick Release Ratchets and Repair Kits



Item Number	Drive Size	No. Teeth	Handle Length	Repair Kit
9572BRQ	1/4"	72	5.5"	9000RK
1872BRQ	3/8"	72	8"	1000RK
21024BRQ	1/2"	24	10"	2000RK

All ratchets are packaged on a display hanger.

DUO

No. 9506WH 1/4" Drive Spinner Handle with Wobble Drive



This hand tool's wobble drive allows up to 15° of deflection for access to tight areas. Its unique design also allows the socket to be locked straight for normal use. Features a friction ball retaining device and female drive in the handle where a ratchet can be used for extra leverage.



Item Number	Drive Size	Handle Length
9506WH	1/4"	5.9"



1/4" Drive Impact Hex Drivers



FOR IMPACT USE ONLY - Warranty void if used with hand tools.

Hex No. 9298HC 1/4" Drive Fractional & Metric Hex Driver Set SAE MM



14 piece set contents:



9904F	1/8"	9902M	2mm
9905F	5/32"	9925M	2.5mm
9906F	3/16"	9903M	3mm
9907F	7/32"	9905M	5mm
9908F	1/4"	9906M	6mm
9910F	5/16"	9907M	7mm
9912F	3/8"	9910M	10mm

Molded Storage Case

Hex 1/4" Drive Fractional Hex Drivers SAE

One piece impact hex drivers in fractional sizes.



Item Number	Hex Size	Dimensions (Inches)			
		A	C	D	E
9904F	1/8"	.51	.83	.24	1.38
9905F	5/32"	.51	.83	.24	1.38
9906F	3/16"	.51	.83	.24	1.38
9907F	7/32"	.51	.83	.24	1.38
9908F	1/4"	.51	.83	.24	1.38
9910F	5/16"	.51	.83	.31	1.38
9912F	3/8"	.51	.83	.39	1.38

Hex 1/4" Drive Metric Hex Drivers MM

One piece impact hex drivers in metric sizes.

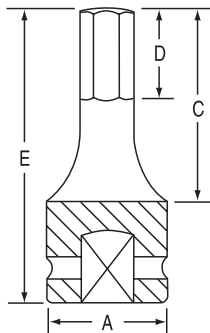

Item Number	Hex Size	Dimensions (Millimeters)			
		A	C	D	E
9902M	2mm	13	21	4	35
9925M	2.5mm	13	21	4	35
9903M	3mm	13	21	6	35
9904M	4mm	13	21	6	35
9905M	5mm	13	21	6	35
9906M	6mm	13	21	6	35
9907M	7mm	13	21	8	35
9908M	8mm	13	21	8	35
9909M	9mm	13	21	10	35
9910M	10mm	13	21	10	35



1/4" Drive Extended Length Impact Hex Driver Sets



FOR IMPACT USE ONLY - Warranty void if used with hand tools.

Hex No. 9247H 1/4" Drive - 4" Length - Fractional Hex Driver Set SAE



4" Length

7 piece set contents:

99044F 1/8"	99084F 1/4"
99054F 5/32"	99104F 5/16"
99064F 3/16"	99124F 3/8"
99074F 7/32"	on a Metal Clip Rail

Hex No. 9267H 1/4" Drive - 6" Length - Fractional Hex Driver Set SAE



6" Length

7 piece set contents:

99046F 1/8"	99086F 1/4"
99056F 5/32"	99106F 5/16"
99066F 3/16"	99126F 3/8"
99076F 7/32"	on a Metal Clip Rail

Hex No. 9249MH 1/4" Drive - 4" Length - Metric Hex Driver Set MM



4" Length

9 piece set contents:

99024M 2mm	99064M 6mm
99254M 2.5mm	99074M 7mm
99034M 3mm	99084M 8mm
99044M 4mm	99104M 10mm
99054M 5mm	on a Metal Clip Rail

Hex No. 9269MH 1/4" Drive - 6" Length - Metric Hex Driver Set MM

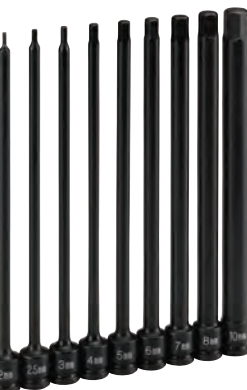

6" Length

9 piece set contents:

99026M 2mm	99066M 6mm
99256M 2.5mm	99076M 7mm
99036M 3mm	99086M 8mm
99046M 4mm	99106M 10mm
99056M 5mm	on a Metal Clip Rail

HEX



1/4" Drive - 4" Length Impact Hex Drivers



FOR IMPACT USE ONLY - Warranty void if used with hand tools.

Hex 1/4" Drive - 4" Length - Fractional Hex Drivers SAE

One piece impact hex drivers in fractional sizes. 4" Extended length for Special Applications.



Item Number	Hex Size	Dimensions (Inches)			
		A	C	D	E
99044F	1/8"	.51	3.39	.24	3.94
99054F	5/32"	.51	3.39	.24	3.94
99064F	3/16"	.51	3.39	.24	3.94
99074F	7/32"	.51	3.39	.24	3.94
99084F	1/4"	.51	3.39	.24	3.94
99104F	5/16"	.51	3.39	.31	3.94
99124F	3/8"	.51	3.39	.39	3.94



Hex 1/4" Drive - 4" Length - Metric Hex Drivers MM

One piece impact hex drivers in metric sizes. 4" Extended length for Special Applications.

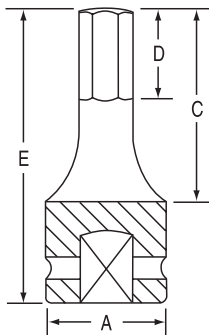

Item Number	Hex Size	Dimensions (Millimeters)			
		A	C	D	E
99024M	2mm	13	86	4	100
99254M	2.5mm	13	86	4	100
99034M	3mm	13	86	6	100
99044M	4mm	13	86	6	100
99054M	5mm	13	86	6	100
99064M	6mm	13	86	6	100
99074M	7mm	13	86	8	100
99084M	8mm	13	86	8	100
99104M	10mm	13	86	10	100



1/4" Drive - 6" Length Impact Hex Drivers



FOR IMPACT USE ONLY - Warranty void if used with hand tools.

Hex 1/4" Drive - 6" Length - Fractional Hex Driver Set SAE

One piece impact hex drivers in fractional sizes. 6" Extended length for Special Applications.

Item Number	Hex Size	Dimensions (Inches)			
		A	C	D	E
99046F	1/8"	.51	5.35	.24	5.91
99056F	5/32"	.51	5.35	.24	5.91
99066F	3/16"	.51	5.35	.24	5.91
99076F	7/32"	.51	5.35	.24	5.91
99086F	1/4"	.51	5.35	.24	5.91
99106F	5/16"	.51	5.35	.31	5.91
99126F	3/8"	.51	5.35	.39	5.91

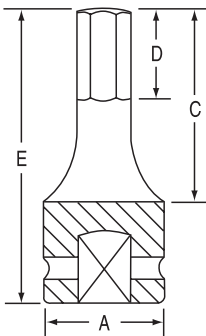

Hex 1/4" Drive - 6" Length - Metric Hex Drivers MM

One piece impact hex drivers in metric sizes. 6" Extended length for Special Applications.

Item Number	Hex Size	Dimensions (Millimeters)			
		A	C	D	E
99026M	2mm	13	136	4	150
99256M	2.5mm	13	136	4	150
99036M	3mm	13	136	6	150
99046M	4mm	13	136	6	150
99056M	5mm	13	136	6	150
99066M	6mm	13	136	6	150
99076M	7mm	13	136	8	150
99086M	8mm	13	136	8	150
99106M	10mm	13	136	10	150

HEX



3/8" Drive Impact Hex Driver Sets



FOR IMPACT USE ONLY - Warranty void if used with hand tools.

Hex No. 1298HC 3/8" Drive Fractional & Metric Hex Driver Set SAE MM



13 piece set contents:

1906F 3/16"	1904M 4mm
1907F 7/32"	1905M 5mm
1908F 1/4"	1906M 6mm
1910F 5/16"/8mm	1907M 7mm
1912F 3/8"	1910M 10mm
1914F 7/16"	1912M 12mm
1916F 1/2"	Molded Storage Case

Hex No. 1297H 3/8" Drive Fractional Hex Driver Set SAE



7 piece set contents:

1906F 3/16"	1912F 3/8"
1907F 7/32"	1914F 7/16"
1908F 1/4"	1916F 1/2"
1910F 5/16"	Molded Storage Case

Hex No. 1297MH 3/8" Drive Metric Hex Driver Set MM



7 piece set contents:

1904M 4mm	1908M 8mm
1905M 5mm	1910M 10mm
1906M 6mm	1912M 12mm
1907M 7mm	Molded Storage Case



3/8" Drive Impact Hex Drivers



FOR IMPACT USE ONLY - Warranty void if used with hand tools.

Hex 3/8" Drive Fractional Hex Drivers SAE

One piece impact hex drivers in fractional sizes.



Item Number	Hex Size	Dimensions (Inches)			
		A	C	D	E
1906F	3/16"	.75	1.22	.63	1.97
1907F	7/32"	.75	1.22	.63	1.97
1908F	1/4"	.75	1.22	.63	1.97
1909F	9/32"	.75	1.22	.63	1.97
1910F	5/16"	.75	1.22	.63	1.97
1912F	3/8"	.75	1.22	.63	1.97
1914F	7/16"	.75	1.22	.63	1.97
1916F	1/2"	.75	1.22	.63	1.97

HEX

Hex 3/8" Drive - 4" Length - Metric Hex Drivers MM

One piece impact hex drivers in metric sizes.

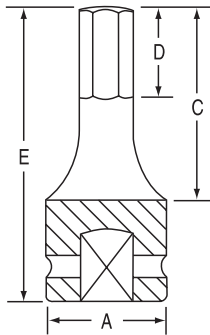

Item Number	Hex Size	Dimensions (Millimeters)			
		A	C	D	E
1904M	4mm	19	31	12	50
1905M	5mm	19	31	12	50
1906M	6mm	19	31	12	50
1907M	7mm	19	31	16	50
1908M	8mm	19	31	16	50
1909M	9mm	19	31	16	50
1910M	10mm	19	31	16	50
1911M	11mm	19	31	16	50
1912M	12mm	19	31	16	50



3/8" Drive Extended Length Impact Hex Driver Sets



FOR IMPACT USE ONLY - Warranty void if used with hand tools.

Hex No. 1247H 3/8" Drive - 4" Length - Fractional Hex Driver Set SAE



4" Length

7 piece set contents:

19064F	3/16"	19124F	3/8"
19074F	7/32"	19144F	7/16"
19084F	1/4"	19164F	1/2"
19104F	5/16"			on a Metal Clip Rail

Hex No. 1267H 3/8" Drive - 6" Length - Fractional Hex Driver Set SAE



6" Length

7 piece set contents:

19066F	3/16"	19126F	3/8"
19076F	7/32"	19146F	7/16"
19086F	1/4"	19166F	1/2"
19106F	5/16"			on a Metal Clip Rail

Hex No. 1247MH 3/8" Drive - 4" Length - Metric Hex Driver Set MM



4" Length

7 piece set contents:

19044M4mm	19084M8mm
19054M5mm	19104M	1.0mm
19064M6mm	19124M	1.2mm
19074M7mm			on a Metal Clip Rail

Hex No. 1267MH 3/8" Drive - 6" Length - Metric Hex Driver Set MM



6" Length

7 piece set contents:

19046M4mm	19086M8mm
19056M5mm	19106M	1.0mm
19066M6mm	19126M	1.2mm
19076M7mm			on a Metal Clip Rail

HEX



3/8" Drive - 4" Length Impact Hex Drivers



FOR IMPACT USE ONLY - Warranty void if used with hand tools.

Hex 3/8" Drive - 4" Length - Fractional Hex Drivers SAE

One piece impact hex drivers in fractional sizes. 4" extended length for special applications.



Item Number	Hex Size	Dimensions (Inches)			
		A	C	D	E
19064F	3/16"	.75	3.23	.43	3.94
19074F	7/32"	.75	3.23	.43	3.94
19084F	1/4"	.75	3.23	.43	3.94
19094F	9/32"	.75	3.23	.43	3.94
19104F	5/16"	.75	3.23	.63	3.94
19124F	3/8"	.75	3.23	.63	3.94
19144F	7/16"	.75	3.23	.63	3.94
19164F	1/2"	.75	3.23	.63	3.94

HEX

Hex 3/8" Drive - 4" Length - Metric Hex Drivers MM

One piece impact hex drivers in metric sizes. 4" extended length for special applications.

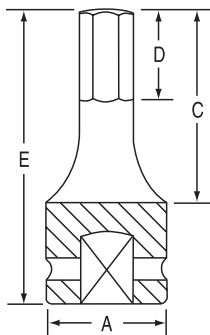

Item Number	Hex Size	Dimensions (Millimeters)			
		A	C	D	E
19044M	4mm	19	82	11	100
19054M	5mm	19	82	11	100
19064M	6mm	19	82	11	100
19074M	7mm	19	82	16	100
19084M	8mm	19	82	16	100
19094M	9mm	19	82	16	100
19104M	10mm	19	82	16	100
19114M	11mm	19	82	16	100
19124M	12mm	19	82	16	100



3/8" Drive - 6" Length Impact Hex Drivers



FOR IMPACT USE ONLY - Warranty void if used with hand tools.

Hex 3/8" Drive - 6" Length - Fractional Hex Drivers SAE

One piece impact hex drivers in fractional sizes. 6" extended length for special applications.



Item Number	Hex Size	Dimensions (Inches)			
		A	C	D	E
19066F	3/16"	.75	5.24	.43	5.91
19076F	7/32"	.75	5.24	.43	5.91
19086F	1/4"	.75	5.24	.43	5.91
19096F	9/32"	.75	5.24	.43	5.91
19106F	5/16"	.75	5.24	.63	5.91
19126F	3/8"	.75	5.24	.63	5.91
19146F	7/16"	.75	5.24	.63	5.91
19166F	1/2"	.75	5.24	.63	5.91

Hex 3/8" Drive - 6" Length - Metric Hex Drivers MM

One piece impact hex drivers in metric sizes. 6" extended length for special applications.

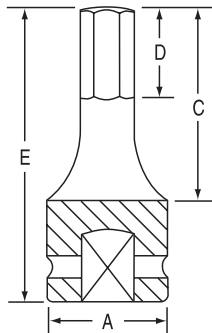

Item Number	Hex Size	Dimensions (Millimeters)			
		A	C	D	E
19046M	4mm	19	133	11	150
19056M	5mm	19	133	11	150
19066M	6mm	19	133	11	150
19076M	7mm	19	133	16	150
19086M	8mm	19	133	16	150
19096M	9mm	19	133	16	150
19106M	10mm	19	133	16	150
19116M	11mm	19	133	16	150
19126M	12mm	19	133	16	150



1/2" Drive Impact Hex Driver Sets



FOR IMPACT USE ONLY - Warranty void if used with hand tools.

Hex No. 1598HC 1/2" Drive Fractional & Metric Hex Driver Set SAE MM



18 piece set contents:

- | | | | | | |
|-------|-------|-----------|-------|-------|---------------------|
| 2908F | | 1/4" | 2906M | | .6mm |
| 2909F | | 9/32" | 2907M | | .7mm |
| 2910F | | 5/16"/8mm | 2910M | | .10mm |
| 2912F | | 3/8" | 2912M | | .12mm |
| 2914F | | 7/16" | 2914M | | .14mm |
| 2916F | | 1/2" | 2915M | | .15mm |
| 2918F | | 9/16" | 2917M | | .17mm |
| 2920F | | 5/8"/16mm | 2918M | | .18mm |
| 2922F | | 11/16" | | | Molded Storage Case |
| 2924F | | 3/4"/19mm | | | |

Hex No. 1398H 1/2" Drive Fractional Hex Driver Set SAE



10 piece set contents:

- | | | | | | |
|-------|-------|-------|-------|-------|---------------------|
| 2908F | | 1/4" | 2916F | | 1/2" |
| 2909F | | 9/32" | 2918F | | 9/16" |
| 2910F | | 5/16" | 2920F | | 5/8" |
| 2912F | | 3/8" | 2922F | | 11/16" |
| 2914F | | 7/16" | 2924F | | 3/4" |
| | | | | | Molded Storage Case |

Hex No. 1498MH 1/2" Drive Metric Hex Driver Set MM



10 piece set contents:

- | | | | | | |
|-------|-------|------|-------|-------|---------------------|
| 2906M | | .6mm | 2914M | | 14mm |
| 2907M | | .7mm | 2915M | | 15mm |
| 2908M | | .8mm | 2917M | | 17mm |
| 2910M | | 10mm | 2918M | | 18mm |
| 2912M | | 12mm | 2919M | | 19mm |
| | | | | | Molded Storage Case |



1/2" Drive Impact Hex Drivers



FOR IMPACT USE ONLY - Warranty void if used with hand tools.

Hex 1/2" Drive Fractional Hex Drivers SAE

One piece impact hex drivers in fractional sizes.



Item Number	Hex Size	Dimensions (Inches)			
		A	C	D	E
2908F	1/4"	.98	2.01	.59	2.95
2909F	9/32"	.98	2.01	.79	2.95
2910F	5/16"	.98	2.01	.98	2.95
2912F	3/8"	.98	2.01	.98	2.95
2914F	7/16"	.98	2.01	.98	2.95
2916F	1/2"	.98	2.01	.98	2.95
2918F	9/16"	.98	2.01	.98	2.95
2920F	5/8"	.98	2.01	.98	2.95
2922F	11/16"	.98	2.01	.98	2.95
2924F	3/4"	.98	2.01	.98	2.95

Hex 1/2" Drive Metric Hex Drivers MM

One piece impact hex drivers in metric sizes.

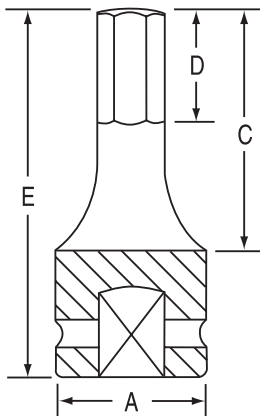

Item Number	Hex Size	Dimensions (Millimeters)			
		A	C	D	E
2906M	6mm	25	51	15	75
2907M	7mm	25	51	20	75
2908M	8mm	25	51	25	75
2909M	9mm	25	51	25	75
2910M	10mm	25	51	25	75
2911M	11mm	25	51	25	75
2912M	12mm	25	51	25	75
2913M	13mm	25	51	25	75
2914M	14mm	25	51	25	75
2915M	15mm	25	51	25	75
2916M	16mm	25	51	25	75
2917M	17mm	25	51	25	75
2918M	18mm	25	51	25	75
2919M	19mm	25	51	25	75



1/2" Drive Extended Length Impact Hex Driver Sets



FOR IMPACT USE ONLY - Warranty void if used with hand tools.

Hex No. 1340H 1/2" Drive - 4" Length - Fractional Hex Driver Set SAE



4" Length

10 piece set contents:

- 29084F 1/4"
- 29094F 9/32"
- 29104F 5/16"
- 29124F 3/8"
- 29144F 7/16"

- 29164F 1/2"
- 29184F 9/16"
- 29204F 5/8"
- 29224F 11/16"
- 29244F 3/4"

on a Metal Clip Rail

Hex No. 1360H 1/2" Drive - 6" Length - Fractional Hex Driver Set SAE



6" Length

10 piece set contents:

- 29086F 1/4"
- 29096F 9/32"
- 29106F 5/16"
- 29126F 3/8"
- 29146F 7/16"

- 29166F 1/2"
- 29186F 9/16"
- 29206F 5/8"
- 29226F 11/16"
- 29246F 3/4"

on a Metal Clip Rail

Hex No. 1343MH 1/2" Drive - 4" Length - Metric Hex Driver Set MM



4" Length

13 piece set contents:

- 29064M 6mm
- 29074M 7mm
- 29084M 8mm
- 29104M 10mm
- 29114M 11mm
- 29124M 12mm
- 29134M 13mm

- 29144M 14mm
- 29154M 15mm
- 29164M 16mm
- 29174M 17mm
- 29184M 18mm
- 29194M 19mm

on a Metal Clip Rail

Hex No. 1363MH 1/2" Drive - 6" Length - Metric Hex Driver Set MM



6" Length

13 piece set contents:

- 29066M 6mm
- 29076M 7mm
- 29086M 8mm
- 29106M 10mm
- 29116M 11mm
- 29126M 12mm
- 29136M 13mm

- 29146M 14mm
- 29156M 15mm
- 29166M 16mm
- 29176M 17mm
- 29186M 18mm
- 29196M 19mm

on a Metal Clip Rail



1/2" Drive - 4" Length Impact Hex Drivers



FOR IMPACT USE ONLY - Warranty void if used with hand tools.

Hex 1/2" Drive - 4" Length - Fractional Hex Drivers SAE

One piece impact hex drivers in fractional sizes. 4" extended length for special applications.



Item Number	Hex Size	Dimensions (Inches)			
		A	C	D	E
29084F	1/4"	.98	2.95	.59	3.94
29094F	9/32"	.98	2.95	.79	3.94
29104F	5/16"	.98	2.95	.98	3.94
29124F	3/8"	.98	2.95	.98	3.94
29144F	7/16"	.98	2.95	.98	3.94
29164F	1/2"	.98	2.95	.98	3.94
29184F	9/16"	1.18	2.95	.98	3.94
29204F	5/8"	1.18	2.95	.98	3.94
29224F	11/16"	1.18	2.95	.98	3.94
29244F	3/4"	1.18	2.95	.98	3.94

Hex 1/2" Drive - 4" Length - Metric Hex Drivers MM

One piece impact hex drivers in metric sizes. 4" extended length for special applications.

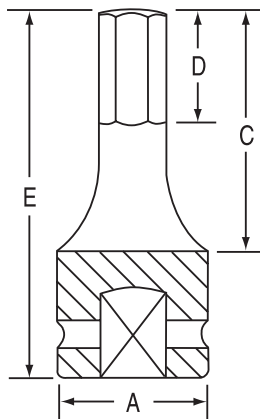

Item Number	Hex Size	Dimensions (Millimeters)			
		A	C	D	E
29064M	6mm	25	75	15	100
29074M	7mm	25	75	20	100
29084M	8mm	25	75	25	100
29094M	9mm	25	75	25	100
29104M	10mm	25	75	25	100
29114M	11mm	25	75	25	100
29124M	12mm	25	75	25	100
29134M	13mm	25	75	25	100
29144M	14mm	30	75	25	100
29154M	15mm	30	75	25	100
29164M	16mm	30	75	25	100
29174M	17mm	30	75	25	100
29184M	18mm	30	75	25	100
29194M	19mm	30	75	25	100



1/2" Drive - 6" Length Impact Hex Drivers



FOR IMPACT USE ONLY - Warranty void if used with hand tools.

Hex 1/2" Drive - 6" Length - Fractional Hex Drivers SAE

One piece impact hex drivers in fractional sizes. 6" extended length for special applications.



Item Number	Hex Size	Dimensions (Inches)			
		A	C	D	E
29086F	1/4"	.98	4.88	.59	5.91
29096F	9/32"	.98	4.88	.79	5.91
29106F	5/16"	.98	4.88	.98	5.91
29126F	3/8"	.98	4.88	.98	5.91
29146F	7/16"	.98	4.88	.98	5.91
29166F	1/2"	.98	4.88	.98	5.91
29186F	9/16"	.98	4.88	.98	5.91
29206F	5/8"	.98	4.88	.98	5.91
29226F	11/16"	.98	4.88	.98	5.91
29246F	3/4"	.98	4.88	.98	5.91

HEX

Hex 1/2" Drive - 6" Length - Metric Hex Drivers MM

One piece impact hex drivers in metric sizes. 6" extended length for special applications.

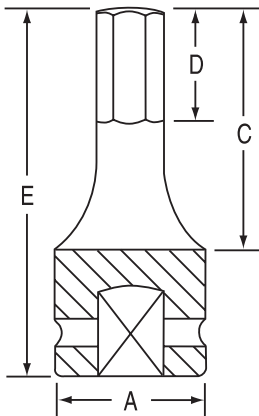

Item Number	Hex Size	Dimensions (Millimeters)			
		A	C	D	E
29066M	6mm	25	124	15	150
29076M	7mm	25	124	20	150
29086M	8mm	25	124	25	150
29096M	9mm	25	124	25	150
29106M	10mm	25	124	25	150
29116M	11mm	25	124	25	150
29126M	12mm	25	124	25	150
29136M	13mm	25	124	25	150
29146M	14mm	25	124	25	150
29156M	15mm	25	124	25	150
29166M	16mm	25	124	25	150
29176M	17mm	25	124	25	150
29186M	18mm	25	124	25	150
29196M	19mm	25	124	25	150



1/2" Drive Universal Impact Hex Drivers



FOR IMPACT USE ONLY - Warranty void if used with hand tools.

Hex No. 1398UH 1/2" Drive Fractional Universal Hex Driver Set SAE



8 piece set contents:

2908UF 1/4"	2916UF 1/2"
2910UF 5/16"	2918UF 9/16"
2912UF 3/8"	2920UF 5/8"
2914UF 7/16"	2924UF 3/4"

Molded Storage Case

Hex No. 1499UMH 1/2" Drive Metric Universal Hex Driver Set MM



9 piece set contents:

2906UM 6mm	2915UM 15mm
2908UM 8mm	2917UM 17mm
2910UM 10mm	2918UM 18mm
2912UM 12mm	2919UM 19mm
2914UM 14mm	

Molded Storage Case

Hex 1/2" Drive Universal Hex Drivers SAE MM

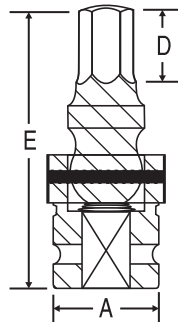

Item Number	Hex Size	Dimensions (Inches/Millimeters)		
		A	D	E
Fractional Sizes				
2908UF	1/4"	1.10	.51	2.95
2910UF	5/16"	1.10	.79	2.95
2912UF	3/8"	1.10	.79	2.95
2914UF	7/16"	1.10	.79	2.95
2916UF	1/2"	1.10	.79	2.95
2918UF	9/16"	1.10	.79	2.95
2920UF	5/8"	1.10	.79	2.95
2924UF	3/4"	1.10	.79	2.95
Metric Sizes				
2906UM	6mm	28	13	75
2908UM	8mm	28	20	75
2910UM	10mm	28	20	75
2912UM	12mm	28	20	75
2914UM	14mm	28	20	75
2915UM	15mm	28	20	75
2917UM	17mm	28	20	75
2918UM	18mm	28	20	75
2919UM	19mm	28	20	75



3/4" Drive Impact Hex Drivers



FOR IMPACT USE ONLY - Warranty void if used with hand tools.

Hex No. 8096H 3/4" Drive Fractional Hex Driver Set SAE



6 piece set contents:

3916F	1/2"	3924F	3/4"
3918F	9/16"	3928F	7/8"
3920F	5/8"	3932F	1"

Molded Storage Case

Hex No. 8196MH 3/4" Drive Metric Hex Driver Set MM



6 piece set contents:

3912M	12mm	3922M	22mm
3914M	14mm	3924M	24mm
3917M	17mm		Molded Storage Case
3919M	19mm		

Hex 3/4" Drive Hex Drivers SAE MM

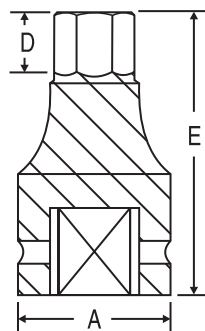

Item Number	Hex Size	Dimensions (Inches)		
		A	D	E
Fractional Sizes				
3916F	1/2"	1.73	.79	3.94
3918F	9/16"	1.73	.79	3.94
3920F	5/8"	1.73	.79	3.94
3924F	3/4"	1.73	.79	3.94
3926F	13/16"	1.73	.79	3.94
3928F	7/8"	1.73	.79	3.94
3932F	1"	1.73	.79	3.94
3934F	1-1/16"	1.73	.79	3.94
3936F	1-1/8"	1.73	.79	3.94
3938F	1-3/16"	1.73	.79	3.94
3940F	1-1/4"	1.73	.79	3.94
Metric Sizes				
3912M	12mm	1.73	.79	3.94
3914M	14mm	1.73	.79	3.94
3917M	17mm	1.73	.79	3.94
3919M	19mm	1.73	.79	3.94
3922M	22mm	1.73	.79	3.94
3924M	24mm	1.73	.79	3.94
3927M	27mm	1.73	.79	3.94
3930M	30mm	1.73	.79	3.94



1" Drive Impact Hex Drivers



FOR IMPACT USE ONLY - Warranty void if used with hand tools.

Hex No. 9096H 1" Drive Fractional Hex Driver Set SAE



6 piece set contents:

4924F 3/4"	4936F 1-1/8"
4928F 7/8"	4940F 1-1/4"
4932F 1"	4944F 1-3/8"

Molded Storage Case

Hex No. 9196MH 1" Drive Metric Hex Driver Set MM



6 piece set contents:

4914M 14mm	4922M 22mm
4917M 17mm	4924M 24mm
4919M 19mm	4927M 27mm

Molded Storage Case

Hex 1" Drive Hex Drivers SAE MM

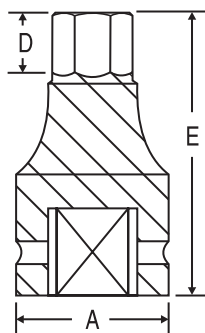

Item Number	Hex Size	Dimensions (Inches/Millimeters)		
		A	D	E
Fractional Sizes				
4920F	5/8"	2.13	.79	3.94
4924F	3/4"	2.13	.79	3.94
4926F	13/16"	2.13	.79	3.94
4928F	7/8"	2.13	.79	3.94
4932F	1"	2.13	.79	3.94
4934F	1-1/16"	2.13	.79	3.94
4936F	1-1/8"	2.13	.79	3.94
4938F	1-3/16"	2.13	.79	3.94
4940F	1-1/4"	2.13	.79	3.94
4942F	1-5/16"	2.13	.79	3.94
4944F	1-3/8"	2.13	.79	3.94
4948F	1-1/2"	2.13	.79	3.94
4952F	1-5/8"	2.13	.79	3.94
4956F	1-3/4"	2.13	.79	3.94

Metric Sizes				
4914M	14mm	54	20	100
4917M	17mm	54	20	100
4919M	19mm	54	20	100
4922M	22mm	54	20	100
4924M	24mm	54	20	100
4927M	27mm	54	20	100
4930M	30mm	54	20	100
4933M	33mm	54	20	100
4936M	36mm	54	20	100
4938M	38mm	54	20	100
4941M	41mm	54	20	100





1-1/2" Drive Impact Hex Drivers



FOR IMPACT USE ONLY - Warranty void if used with hand tools.

Hex 1-1/2" Drive Fractional Hex Drivers SAE

One piece impact hex drivers in fractional sizes.



Item Number	Hex Size	Dimensions (Inches)		
		A	D	E
6924F	3/4"	3.39	.79	4.72
6926F	13/16"	3.39	.79	4.72
6928F	7/8"	3.39	.79	4.72
6930F	15/16"	3.39	.79	4.72
6932F	1"	3.39	.79	4.72
6934F	1-1/16"	3.39	.79	4.72
6936F	1-1/8"	3.39	.79	4.72
6938F	1-3/16"	3.39	.79	4.72
6940F	1-1/4"	3.39	.79	4.72
6942F	1-5/16"	3.39	.79	4.72
6944F	1-3/8"	3.39	.79	4.72
6948F	1-1/2"	3.39	.79	4.72
6952F	1-5/8"	3.39	.79	4.72
6956F	1-3/4"	3.39	.79	4.72
6958F	1-13/16"	3.39	.79	4.72
6964F	2"	3.39	.79	4.72
6968F	2-1/8"	3.39	.79	4.72
6970F	2-3/16"	3.39	.79	4.72

HEX

Hex 1-1/2" Drive Metric Hex Drivers MM

One piece impact hex drivers in metric sizes.

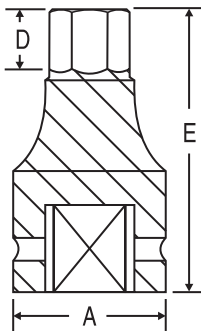

Item Number	Hex Size	Dimensions (Millimeters)		
		A	D	E
6919M	19mm	86	20	120
6922M	22mm	86	20	120
6924M	24mm	86	20	120
6927M	27mm	86	20	120
6930M	30mm	86	20	120
6932M	32mm	86	20	120
6933M	33mm	86	20	120
6936M	36mm	86	20	120
6938M	38mm	86	20	120
6941M	41mm	86	20	120
6946M	46mm	86	20	120
6950M	50mm	86	20	120
6955M	55mm	86	20	120



Internal Star Impact Drivers



FOR IMPACT USE ONLY - Warranty void if used with hand tools.

No. 1234T 1/4", 3/8", 1/2" Drive Internal Star Set



12 piece set contents:

- 6 Pieces 1/4" Drive Star Sizes:
T10, T15, T20, T25, T27, T30
- 5 Pieces 3/8" Drive Star Sizes:
T40, T45, T47, T50, T55
- 1 Piece 1/2" Drive Star Size:
T60
- Molded Storage Case

No. 996T 1/4" Drive Internal Star Set



6 piece set contents:

- 6 Pieces 1/4" Drive Internal Star Sizes:
T10, T15, T20, T25, T27, T30
- on a Metal Clip Rail

1/4" Drive Individual Internal Star Drivers

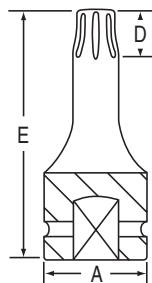

Item Number	Star Size	Dimensions (Inches)		
		A	D	E
910T	T10	.51	.11	1.38
915T	T15	.51	.11	1.38
920T	T20	.51	.11	1.38
925T	T25	.51	.12	1.38
927T	T27	.51	.12	1.38
930T	T30	.51	.15	1.38



3/8" Drive Internal Star Impact Drivers



FOR IMPACT USE ONLY - Warranty void if used with hand tools.

No. 1200T 3/8" Drive Internal Star Set



9 piece set contents:

9 Pieces 3/8" Drive Internal Star Sizes:
T20, T25, T27, T30, T40, T45, T47, T50, T55
Molded Storage Case



3/8" Drive Individual Internal Star Drivers



Item Number	Star Size	Dimensions (Inches)		
		A	D	E
1120T	T20	.75	.11	1.97
1125T	T25	.75	.12	1.97
1127T	T27	.75	.12	1.97
1130T	T30	.75	.15	1.97
1140T	T40	.75	.15	1.97
1145T	T45	.75	.17	1.97
1147T	T47	.75	.20	1.97
1150T	T50	.75	.20	1.97
1155T	T55	.75	.22	1.97

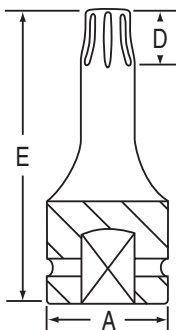

Star



3/8" Drive Extended Length Internal Star Impact Drivers



FOR IMPACT USE ONLY - Warranty void if used with hand tools.

★ No. 1206T 3/8" Drive Extended Length Internal Star Set



9 piece set contents:

11206TT20	11456TT45
11256TT25	11476TT47
11276TT27	11506TT50
11306TT30	11556TT55
11406TT40		on a Metal Clip Rail

★ 3/8" Drive Individual Extended Length Internal Star Drivers

These extended length Star drivers with 6" overall length are designed for a wide variety of applications where long reach is needed. They are especially useful for automotive trim work as well as many industrial applications.

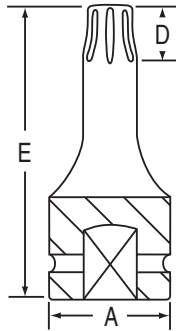

Item Number	Star Size	Dimensions (Inches)		
		A	D	E
11206T	T20	.75	.11	5.91
11256T	T25	.75	.12	5.91
11276T	T27	.75	.12	5.91
11306T	T30	.75	.15	5.91
11406T	T40	.75	.15	5.91
11456T	T45	.75	.17	5.91
11476T	T47	.75	.20	5.91
11506T	T50	.75	.20	5.91
11556T	T55	.75	.22	5.91

Star



1/2" Drive Internal Star Impact Drivers



FOR IMPACT USE ONLY - Warranty void if used with hand tools.

No. 1300T 1/2" Drive Internal Star Set



8 piece set contents:

8 Pieces 1/2" Drive Internal Star Sizes:
T30, T40, T45, T47, T50, T55, T60, T70
Molded Storage Case



1/2" Drive Individual Internal Star Drivers



Item Number	Star Size	Dimensions (Inches)		
		A	D	E
2130T	T30	.98	.15	2.95
2140T	T40	.98	.15	2.95
2145T	T45	.98	.17	2.95
2147T	T47	.98	.20	2.95
2150T	T50	.98	.20	2.95
2155T	T55	.98	.22	2.95
2160T	T60	.98	.31	2.95
2170T	T70	.98	.37	2.95

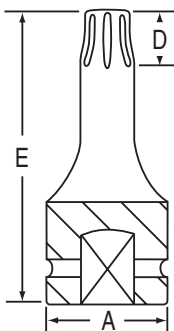

Star



Tamper-Proof Star Impact Drivers



FOR IMPACT USE ONLY - Warranty void if used with hand tools.

⚙️ No. 1235TT 1/4", 3/8", 1/2" Drive Tamper-Proof Star Set

Tamper-Proof



12 piece set contents:

- 6 Pieces 1/4" Drive Star Sizes:
TT10, TT15, TT20, TT25, TT27, TT30
- 5 Pieces 3/8" Drive Star Sizes:
TT40, TT45, TT47, TT50, TT55
- 1 Piece 1/2" Drive Star Size:
TT60
- Molded Storage Case

⚙️ 1/4" Drive Individual Tamper-Proof Star Drivers

Tamper-Proof

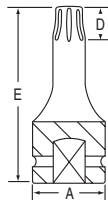

Item Number	Star Size	Dimensions (Inches)		
		A	D	E
908TT	TT8	.51	.08	1.38
909TT	TT9	.51	.08	1.38
910TT	TT10	.51	.11	1.38
915TT	TT15	.51	.11	1.38
920TT	TT20	.51	.11	1.38
925TT	TT25	.51	.12	1.38
927TT	TT27	.51	.12	1.38
930TT	TT30	.51	.15	1.38

⚙️ 3/8" Drive Individual Tamper-Proof Star Drivers

Tamper-Proof

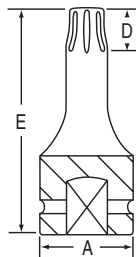

Item Number	Star Size	Dimensions (Inches)		
		A	D	E
1120TT	TT20	.75	.11	1.97
1125TT	TT25	.75	.12	1.97
1127TT	TT27	.75	.12	1.97
1130TT	TT30	.75	.15	1.97
1140TT	TT40	.75	.15	1.97
1145TT	TT45	.75	.17	1.97
1147TT	TT47	.75	.20	1.97
1150TT	TT50	.75	.20	1.97
1155TT	TT55	.75	.22	1.97

⚙️ 1/2" Drive Individual Tamper-Proof Star Drivers

Tamper-Proof

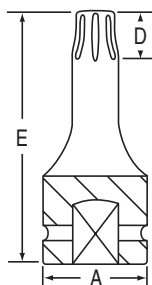

Item Number	Star Size	Dimensions (Inches)		
		A	D	E
2130TT	TT30	.98	.15	2.95
2140TT	TT40	.98	.15	2.95
2145TT	TT45	.98	.17	2.95
2147TT	TT47	.98	.20	2.95
2150TT	TT50	.98	.20	2.95
2155TT	TT55	.98	.22	2.95
2160TT	TT60	.98	.31	2.95
2170TT	TT70	.98	.37	2.95



1/4" Drive External Star Impact Sockets



FOR IMPACT USE ONLY - Warranty void if used with hand tools.

ET No. 998ET 1/4" Drive External Star Socket Set

8 piece set contents:

8 Pieces 1/4" Drive External Star Sizes:
E4, E5, E6, E7, E8, E10, E11, E12
on a Metal Clip Rail



ET 1/4" Drive Individual External Star Sockets



Item Number	Star Size	Shape	Dimensions (Inches)		
			A	B	E
904ET	E4	I	.51	.22	.98
905ET	E5	I	.51	.28	.98
906ET	E6	I	.51	.31	.98
907ET	E7	I	.51	.35	.98
908ET	E8	I	.51	.39	.98
910ET	E10	I	.51	.47	.98
911ET	E11	II	.51	.49	.98
912ET	E12	II	.57	.55	.98

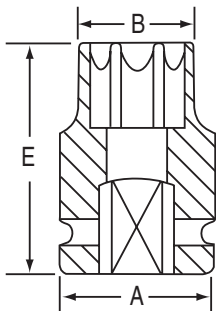

Star



3/8" Drive External Star Impact Sockets



FOR IMPACT USE ONLY - Warranty void if used with hand tools.

ET No. 1219ET 3/8" Drive External Star Socket Set



9 piece set contents:

9 Pieces 3/8" Drive External Star Sizes:
E5, E6, E7, E8, E10, E11, E12, E14, E16
Molded Storage Case



ET 3/8" Drive Individual External Star Sockets



Dimensions (Inches)

Item Number	Star Size	Dimensions (Inches)				
		A	B	C	D	E
1105ET	E5	.75	.28	.79	.18	1.26
1106ET	E6	.75	.31	.79	.20	1.26
1107ET	E7	.75	.35	.79	.24	1.26
1108ET	E8	.75	.39	.79	.26	1.26
1110ET	E10	.75	.47	.79	.30	1.26
1111ET	E11	.75	.51	.79	.31	1.26
1112ET	E12	.75	.55	.79	.33	1.26
1114ET	E14	.75	.65	.79	.39	1.26
1116ET	E16	.75	.72	.79	.43	1.26

Star

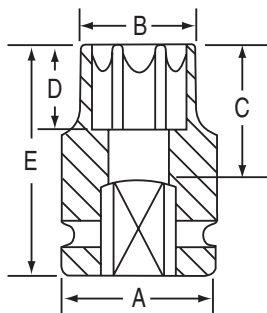



1/2" Drive External Star Impact Sockets



FOR IMPACT USE ONLY - Warranty void if used with hand tools.

ET No. 1319ET 1/2" Drive External Star Socket Set



9 piece set contents:

9 Pieces 1/2" Drive External Star Sizes:
E10, E11, E12, E14, E16, E18, E20, E22, E24
Molded Storage Case



ET 1/2" Drive Individual External Star Sockets



Item Number	Star Size	Dimensions (Inches)				
		A	B	C	D	E
2110ET	E10	.98	.47	.83	.30	1.50
2111ET	E11	.98	.51	.83	.31	1.50
2112ET	E12	.98	.55	.83	.33	1.50
2114ET	E14	.98	.65	.83	.39	1.50
2116ET	E16	.98	.72	.83	.43	1.50
2118ET	E18	.98	.81	.83	.49	1.50
2120ET	E20	1.18	.89	.83	.55	1.50
2122ET	E22	1.18	.96	1.10	.59	1.77
2124ET	E24	1.18	1.04	1.10	.65	1.77

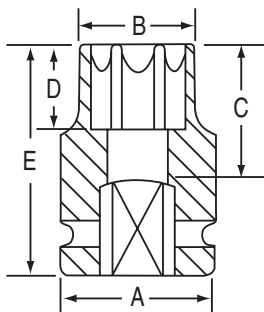

Star



3/8" Drive Triple Square Impact Driver Sets



FOR IMPACT USE ONLY - Warranty void if used with hand tools.

No. 1207S 3/8" Drive Triple Square Driver Set



7 piece set contents:

1105S	M5	1112S	M12
1106S	M6	1114S	M14
1108S	M8	1116S	M16
1110S	M10		on a Metal Clip Rail

No. 1247S 3/8" Drive - 4" Length - Triple Square Driver Set



4" Length

7 piece set contents:

11054S	M5	11124S	M12
11064S	M6	11144S	M14
11084S	M8	11164S	M16
11104S	M10		on a Metal Clip Rail

No. 1207ST 3/8" Drive Tamper-Proof Triple Square Driver Set

Tamper-Proof



7 piece set contents:

1105ST	M5	1112ST	M12
1106ST	M6	1114ST	M14
1108ST	M8	1116ST	M16
1110ST	M10		on a Metal Clip Rail

No. 1247ST 3/8" Drive - 4" Length - Tamper-Proof Triple Square Driver Set

Tamper-Proof



4" Length

7 piece set contents:

11054ST	M5	11124ST	M12
11064ST	M6	11144ST	M14
11084ST	M8	11164ST	M16
11104ST	M10		on a Metal Clip Rail

Triple Square



3/8" Drive Triple Square Impact Drivers



FOR IMPACT USE ONLY - Warranty void if used with hand tools.

3/8" Drive Triple Square Drivers

One piece Triple Square drivers in standard length.



Item Number	Size	Dimensions (Inches)				
		A	B	C	D	E
1105S	M5	.75	.17	1.23	.34	1.98
1106S	M6	.75	.22	1.23	.36	1.98
1108S	M8	.75	.27	1.23	.50	1.98
1110S	M10	.75	.36	1.23	.50	1.98
1112S	M12	.75	.43	1.23	.61	1.98
1114S	M14	.75	.50	1.23	.61	1.98
1116S	M16	.75	.59	1.23	.73	1.98

3/8" Drive - 4" Length - Triple Square Drivers

One piece Triple Square drivers in 4" extended length for special applications.



4" Length

Item Number	Size	Dimensions (Inches)				
		A	B	C	D	E
11054S	M5	.75	.17	1.23	.34	3.94
11064S	M6	.75	.22	3.23	.36	3.94
11084S	M8	.75	.27	3.23	.50	3.94
11104S	M10	.75	.36	3.23	.50	3.94
11124S	M12	.75	.43	3.23	.61	3.94
11144S	M14	.75	.50	3.23	.61	3.94
11164S	M16	.75	.59	3.23	.73	3.94

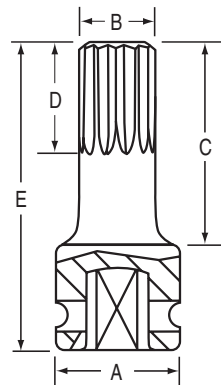

Triple Square



3/8" Drive Tamper-Proof Triple Square Impact Drivers



FOR IMPACT USE ONLY - Warranty void if used with hand tools.

3/8" Drive Tamper-Proof Triple Square Drivers

Tamper-Proof

One piece Tamper-Proof Triple Square drivers in standard length.



Item Number	Size	Dimensions (Inches)				
		A	B	C	D	E
1105ST	M5	.75	.17	1.23	.34	1.98
1106ST	M6	.75	.22	1.23	.36	1.98
1108ST	M8	.75	.27	1.23	.50	1.98
1110ST	M10	.75	.36	1.23	.50	1.98
1112ST	M12	.75	.43	1.23	.61	1.98
1114ST	M14	.75	.50	1.23	.61	1.98
1116ST	M16	.75	.59	1.23	.73	1.98

3/8" Drive - 4" Length - Tamper-Proof Triple Square Drivers

Tamper-Proof

One piece Tamper-Proof Triple Square drivers in 4" extended length for special applications.



4" Length

Item Number	Size	Dimensions (Inches)				
		A	B	C	D	E
11054ST	M5	.75	.17	3.23	.34	3.94
11064ST	M6	.75	.22	3.23	.36	3.94
11084ST	M8	.75	.27	3.23	.50	3.94
11104ST	M10	.75	.36	3.23	.50	3.94
11124ST	M12	.75	.43	3.23	.61	3.94
11144ST	M14	.75	.50	3.23	.61	3.94
11164ST	M16	.75	.59	3.23	.73	3.94

Triple Square

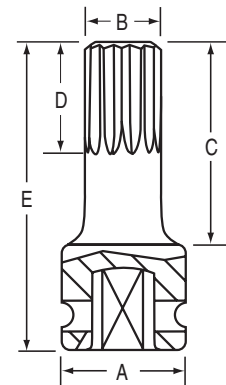



1/2" Drive Triple Square Impact Driver Sets



FOR IMPACT USE ONLY - Warranty void if used with hand tools.

No. 1307S 1/2" Drive Triple Square Driver Set



7 piece set contents:

2105S	M5	2112S	M12
2106S	M6	2114S	M14
2108S	M8	2116S	M16
2110S	M10		on a Metal Clip Rail

No. 1347S 1/2" Drive - 4" Length - Triple Square Driver Set



4" Length

7 piece set contents:

21054S	M5	21124S	M12
21064S	M6	21144S	M14
21084S	M8	21164S	M16
21104S	M10		on a Metal Clip Rail

No. 1307ST 1/2" Drive Tamper-Proof Triple Square Driver Set

Tamper-Proof



7 piece set contents:

2105ST	M5	2112ST	M12
2106ST	M6	2114ST	M14
2108ST	M8	2116ST	M16
2110ST	M10		on a Metal Clip Rail

No. 1347ST 1/2" Drive - 4" Length - Tamper-Proof Triple Square Driver Set

Tamper-Proof



4" Length

7 piece set contents:

21054ST	M5	21124ST	M12
21064ST	M6	21144ST	M14
21084ST	M8	21164ST	M16
21104ST	M10		on a Metal Clip Rail



1/2" Drive Triple Square Impact Drivers



FOR IMPACT USE ONLY - Warranty void if used with hand tools.

1/2" Drive Triple Square Drivers

One piece Triple Square drivers in standard length.



Item Number	Size	Dimensions (Inches)				
		A	B	C	D	E
2105S	M5	.98	.17	1.22	.37	2.17
2106S	M6	.98	.22	1.22	.40	2.17
2108S	M8	.98	.27	1.22	.47	2.17
2110S	M10	.98	.36	1.22	.52	2.17
2112S	M12	.98	.43	1.22	.64	2.17
2114S	M14	.98	.50	1.22	.64	2.17
2116S	M16	.98	.59	1.22	.73	2.17

1/2" Drive - 4" Length - Triple Square Drivers

One piece Triple Square drivers in 4" extended length for special applications.



4" Length

Item Number	Size	Dimensions (Inches)				
		A	B	C	D	E
21054S	M5	.98	.17	2.96	.37	3.94
21064S	M6	.98	.22	2.96	.40	3.94
21084S	M8	.98	.27	2.96	.47	3.94
21104S	M10	.98	.36	2.96	.52	3.94
21124S	M12	.98	.43	2.96	.64	3.94
21144S	M14	.98	.50	2.96	.64	3.94
21164S	M16	.98	.59	2.96	.73	3.94

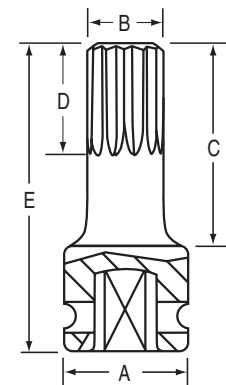

Triple Square



1/2" Drive Tamper-Proof Triple Square Impact Drivers



FOR IMPACT USE ONLY - Warranty void if used with hand tools.

1/2" Drive Tamper-Proof Triple Square Drivers

Tamper-Proof

One piece Tamper-Proof Triple Square drivers in standard length.



Item Number	Size	Dimensions (Inches)				
		A	B	C	D	E
2105ST	M5	.98	.17	1.22	.37	2.17
2106ST	M6	.98	.22	1.22	.40	2.17
2108ST	M8	.98	.27	1.22	.47	2.17
2110ST	M10	.98	.36	1.22	.52	2.17
2112ST	M12	.98	.43	1.22	.64	2.17
2114ST	M14	.98	.50	1.22	.64	2.17
2116ST	M16	.98	.59	1.22	.73	2.17

1/2" Drive - 4" Length - Tamper-Proof Triple Square Drivers

Tamper-Proof

One piece Tamper-Proof Triple Square drivers in 4" extended length for special applications.



4" Length

Item Number	Size	Dimensions (Inches)				
		A	B	C	D	E
21054ST	M5	.98	.17	2.96	.37	3.94
21064ST	M6	.98	.22	2.96	.40	3.94
21084ST	M8	.98	.27	2.96	.47	3.94
21104ST	M10	.98	.36	2.96	.52	3.94
21124ST	M12	.98	.43	2.96	.64	3.94
21144ST	M14	.98	.50	2.96	.64	3.94
21164ST	M16	.98	.59	2.96	.73	3.94

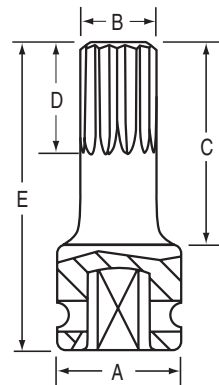



1/2" Drive Torque Limiting Impact Extensions



Always follow manufacturer's recommended torque specifications when using these products.

No. 2805TK 1/2" Drive Torque Limiting Extension Set



Provides the ability to torque wheel nuts on passenger cars and light trucks to the correct torque. Designed for use with our thin wall impact sockets. Available in a set or individually.

5 piece set contents:

Item Number	Torque ft./lbs.	Color
28065	65	Yellow
28080	80	Blue
28100	100	Gray
28120	120	White
28140	140	Aqua



1/2" Drive Individual Torque Limiting Extensions

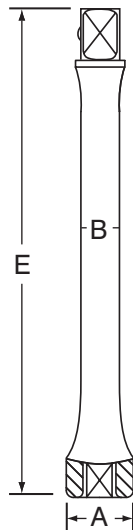

Item Number	Torque ft./lbs	Color	Dimensions (Inches)		
			A	B	E
28065	65	Yellow	1.07	.36	7.63
28080	80	Blue	1.07	.43	7.63
28100	100	Gray	1.07	.48	7.63
28120	120	White	1.07	.54	7.63
28140	140	Aqua	1.07	.60	7.63

Torque Limiting





No. 103RA Reducing Adapter Set - Sleeve Type - Low Profile

These adapters reduce larger drive sizes down for use on smaller drive tools. The low profile design allows for use in a wide range of applications. A magnetic retention device keeps the adapter attached to the socket. Adapters can be stacked if additional drive reduction is needed. Designed for impact or hand tool use.



3 piece set contents:

1 ea: 938RA, 1138RA and 2238RA

Three piece set is conveniently packaged in a blister pack.

Individual Reducing Adapters - Sleeve Type - Low Profile

Item Number	Female End Size	Male End Size
938RA	1/4"	3/8"
912RA	1/4"	1/2"
1138RA	3/8"	1/2"
2238RA	1/2"	3/4"
3009RA	3/4"	1"
4009RA	1"	1-1/2"
6009RA	1-1/2"	2-1/2"

Impact Wrench Quick Change Adapters

These adapters provide a "quick change" mechanism by the use of a sliding collar and positive retention ball for fast change of a socket on the end of the tool anvil. Works with Impact tool anvils that have a clip retention device or pin hole. A pin hole type anvil and use of a pin and retaining o-ring recommended to secure this adapter to the anvil.

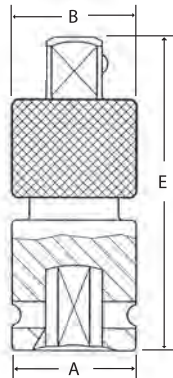

Item Number	Description	Dimensions (Inches)		
		A	B	E
930QC	1/4" Drive Quick Change Adapter	.51	.53	1.38
1130QC	3/8" Drive Quick Change Adapter	.79	.81	1.82
2230QC	1/2" Drive Quick Change Adapter	.98	1.00	2.38
3030QC	3/4" Drive Quick Change Adapter	1.74	1.76	3.18
4030QC	1" Drive Quick Change Adapter	2.13	2.15	3.95

No. 20265B 1/2" Drive 13/16" 5-Point Utility Socket SAE

This socket is designed for use on tamper-proof buffalo covers used by water and gas utility companies.



Item Number	Size	Dimensions (Inches)	
		Dimension	Length
20265B	13/16" 5-Point	1.25"	2.00"



1/4" Hex to Square Drive Drill Chuck Adapters

These adapters allow the use of GP Impact Sockets on a standard drill chuck and are especially useful with our magnetic sockets. They are made from the same high quality steel as our Impact Sockets for extra durability and long life.



1403HA 3 Piece Set - includes 1414HA, 1438HA, 1412HA

Item Number	Hex Size	Square Drive	Length
1414HA	1/4"	1/4"	2"
1438HA	1/4"	3/8"	2"
1412HA	1/4"	1/2"	2"
14144HA	1/4"	1/4"	4"
14384HA	1/4"	3/8"	4"
14124HA	1/4"	1/2"	4"
14146HA	1/4"	1/4"	6"
14386HA	1/4"	3/8"	6"
14126HA	1/4"	1/2"	6"



All adapters feature a spring loaded friction ball retainer.

Impact Socket Clip Rails

A variety of clip rails are available for "custom sizing" your impact socket sets.



Rails & Clips sold separately

Item Number	Drive Size	Rail Length
RAILS		
CLR5	-	5.250
CLR7	-	7.375
CLR9	-	9.250
CLR11	-	11.000
CLR13	-	13.500
CLR14	-	14.000
CLIPS		
CL14	1/4"	-
CL38	3/8"	-
CL12	1/2"	-
CL34	3/4"	-

Specials



No. 2412 Inner Cap Nut Removal Kit

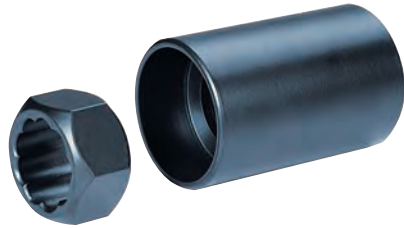

This kit removes inner cap nuts on budd wheels when the square head of the nut has broken off. Simply drive the rib nut over the broken cap nut and remove with an impact wrench.

2 piece set contents:

- 2414 Drive-on Tool
- 2415* 1-1/8" Rib Nut

No. 2413 Inner Cap Nut & Wheel Stud Removal Kit



This kit removes inner cap nuts on budd wheels when the square head of the nut has broken off. Also included are rib nuts to remove 5/8" and 3/4" spoke wheel studs. Simply drive the rib nut over the broken cap nut or wheel stud and remove with an impact wrench.

4 piece set contents:

- 2414 Drive-on Tool
- 2415* 1-1/8" Rib Nut
- 2416* 5/8" Rib Nut
- 2417* 3/4" Rib Nut

Replacement Parts For Cap Nut & Stud Removal Tools

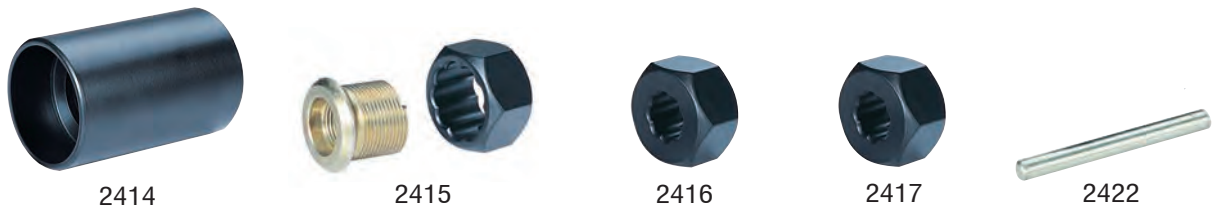

Item Number	Description	Application
2414	Drive-On Tool Only	Tool for Driving on all Rib Nuts
2415*	1-1/8" (13/16" Sq. Head) Rib Nut	For removing broken 13/16" Square Inner Cap Nuts
2416*	5/8" Rib Nut	For removing broken 5/8" Wheel Studs
2417*	3/4" Rib Nut	For removing broken 3/4" Wheel Studs
2422	Drive Pin	Removes Cap Nut from Rib Nut

* The teeth of the rib nuts will wear out after limited use, therefore, rib nuts are not covered under the GP Warranty.



1 Piece Broken Cap Nut & Wheel Stud Removal Tools

One-Piece tools for the removal of broken/stripped inner cap nuts and spoke wheel studs. When hammered on, self tapping spines cut grooves down the stud for easy removal.



Item Number	Description	Application
2515*	1-1/8" Inner Cap Nut Removal Tool 2-3/4" Long	For removing 13/16" square Head Inner Cap Nuts
2516*	5/8" Wheel Stud Removal Tool	For removing 5/8" Broken Wheel Studs
2517*	3/4" Wheel Stud Removal Tool	For removing 3/4" square Broken Wheel Studs

* The Teeth of these tools will wear out after limited use, therefore, they are not covered under the GP Warranty.

Stud Setter for Installing Spoke Wheel Studs

Special tool for installing studs on cast spoke wheels. Used with 1-1/4" hex socket.



Item Number	Description	Application
2617	3/4" Stud Installer	For installing 3/4"-10 Wheel Studs

3/4" Drive Stud Setter Impact Socket

Our special impact sockets for installing wheel studs. Same Function as No. 2617 above, except, there is no need to use a socket to drive the tool. The 3/4" size is also available in 3/4" drive.

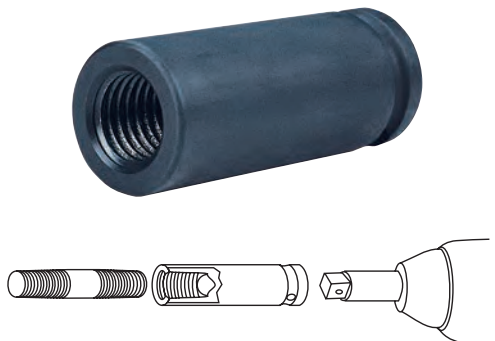

Item Number	Drive Size	Description	Application
2621	3/4"	3/4" Stud Setter Impact Socket	For installing 3/4"-10 Wheel Studs



All items on this page are covered by a one year limited warranty.

Tread Depth Gauges

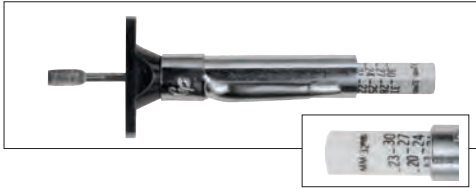

Accurate, high quality tread depth gauges calibrated in inches (1/32") or in inches and metric. Easy to read. 1" nylon base. Nylon & metal construction.

Item Number	Description
1624	Fractional Tread Depth Gauge
1625M	Fractional & Metric T.D. Gauge

Nylon Valve Stem Installation Tool



Nylon model protects custom wheels from damage.

Item Number	Description
1638C	Nylon Valve Stem Installation Tool

Standard Wheel Weight Tool



An economical wheel weight tool for regular (uncoated) wheel weights. Installs, removes and trims clip-on wheel weights. Overall length: 9"

Item Number	Description
1470R	Wheel Weight Tool



3/8" Drive Fractional & Metric Impact Socket Displays



6 No. D162 3/8" Drive 6-Point Fractional & Metric Display SAE MM



Dimensions:
 Wall Mount: 24" W x 48-1/2" H x 8" D
 Free Standing: 24" W x 55-1/4" H x 15-1/2" D
 Weight: 61.0 lbs.

124 Piece Display Contents:

Attachments:

- 2- **1128A** ... 3/8" F. x 1/4" M. Adapter
- 2- **1129UJ** ... 3/8" x 3/8" Universal Joint
- 2- **1138A** ... 3/8" F. x 1/2" M. Adapter
- 2- **1140E** ... 1-3/4" Extension
- 2- **1143E** ... 3" Extension
- 2- **1146E** ... 6" Extension

3/8" Drive Fractional Sizes:

- 2- **1010R** 5/16"
- 2- **1012R** 3/8"
- 2- **1014R** 7/16"
- 2- **1016R** 1/2"
- 2- **1018R** 9/16"
- 2- **1020R** 5/8"
- 2- **1022R** 11/16"
- 2- **1024R** 3/4"
- 2- **1026R** 13/16"
- 2- **1028R** 7/8"
- 2- **1030R** 15/16"
- 2- **1032R** 1"

3/8" Drive Deep Fractional Sizes:

- 2- **1010D** 5/16"
- 2- **1012D** 3/8"
- 2- **1014D** 7/16"
- 2- **1016D** 1/2"
- 2- **1018D** 9/16"
- 2- **1020D** 5/8"
- 2- **1022D** 11/16"
- 2- **1024D** 3/4"
- 2- **1026D** 13/16"
- 2- **1028D** 7/8"
- 2- **1030D** 15/16"
- 2- **1032D** 1"

3/8" Drive Metric Sizes:

- 2- **1007M** 7mm
- 2- **1008M** 8mm
- 2- **1009M** 9mm
- 2- **1010M** 10mm
- 2- **1011M** 11mm
- 2- **1012M** 12mm
- 2- **1013M** 13mm
- 2- **1014M** 14mm
- 2- **1015M** 15mm
- 2- **1016M** 16mm
- 2- **1017M** 17mm
- 2- **1018M** 18mm
- 2- **1019M** 19mm
- 2- **1020M** 20mm
- 2- **1021M** 21mm
- 2- **1022M** 22mm

3/8" Drive Deep Metric Sizes:

- 2- **1007MD** 7mm
- 2- **1008MD** 8mm
- 2- **1009MD** 9mm
- 2- **1010MD** 10mm
- 2- **1011MD** 11mm
- 2- **1012MD** 12mm
- 2- **1013MD** 13mm
- 2- **1014MD** 14mm
- 2- **1015MD** 15mm
- 2- **1016MD** 16mm
- 2- **1017MD** 17mm
- 2- **1018MD** 18mm
- 2- **1019MD** 19mm
- 2- **1020MD** 20mm
- 2- **1021MD** 21mm
- 2- **1022MD** 22mm

12 No. D156-12 3/8" Drive 12-Point Fractional & Metric Display SAE MM



112 Piece Display Contents:

3/8" Drive Fractional Sizes:

- 2- **1110R** 5/16"
- 2- **1112R** 3/8"
- 2- **1114R** 7/16"
- 2- **1116R** 1/2"
- 2- **1118R** 9/16"
- 2- **1120R** 5/8"
- 2- **1122R** 11/16"
- 2- **1124R** 3/4"
- 2- **1126R** 13/16"
- 2- **1128R** 7/8"
- 2- **1130R** 15/16"
- 2- **1132R** 1"

3/8" Drive Deep Fractional Sizes:

- 2- **1110D** 5/16"
- 2- **1102D** 3/8"
- 2- **1114D** 7/16"
- 2- **1116D** 1/2"
- 2- **1118D** 9/16"
- 2- **1120D** 5/8"
- 2- **1122D** 11/16"
- 2- **1124D** 3/4"
- 2- **1126D** 13/16"
- 2- **1128D** 7/8"
- 2- **1130D** 15/16"
- 2- **1132D** 1"

3/8" Drive Metric Sizes:

- 2- **1107M** 7mm
- 2- **1108M** 8mm
- 2- **1109M** 9mm
- 2- **1110M** 10mm
- 2- **1111M** 11mm
- 2- **1112M** 12mm
- 2- **1113M** 13mm
- 2- **1114M** 14mm
- 2- **1115M** 15mm
- 2- **1116M** 16mm
- 2- **1117M** 17mm
- 2- **1118M** 18mm
- 2- **1119M** 19mm
- 2- **1120M** 20mm
- 2- **1121M** 21mm
- 2- **1122M** 22mm

3/8" Drive Deep Metric Sizes:

- 2- **1107MD** 7mm
- 2- **1108MD** 8mm
- 2- **1109MD** 9mm
- 2- **1110MD** 10mm
- 2- **1111MD** 11mm
- 2- **1112MD** 12mm
- 2- **1113MD** 13mm
- 2- **1114MD** 14mm
- 2- **1115MD** 15mm
- 2- **1116MD** 16mm
- 2- **1117MD** 17mm
- 2- **1118MD** 18mm
- 2- **1119MD** 19mm
- 2- **1120MD** 20mm
- 2- **1121MD** 21mm
- 2- **1122MD** 22mm

Dimensions:
 Wall Mount: 24" W x 48-1/2" H x 8" D
 Free Standing: 24" W x 55-1/4" H x 15-1/2" D
 Weight: 59.0 lbs.



1/2" Drive Fractional & Metric Impact Socket Displays



6 No. D298 1/2" Drive 6-Point Fractional & Metric Display **SAE** **MM**



104 Piece Display Contents:

Attachments:

- 2- 2228A 1/2" F.x 3/8" M. Adapter
- 2- 2229UJ 1/2" Universal Joint
- 2- 2238A 1/2" F.x 3/4" M. Adapter
- 2- 2243E3" Extension
- 2- 2245E5" Extension
- 2- 2247E7" Extension

1/2" Drive Fractional Sizes:

- 1- 2010R5/16"
- 1- 2012R3/8"
- 1- 2014R7/16"
- 1- 2016R1/2"
- 1- 2018R9/16"
- 1- 2020R5/8"
- 1- 2022R11/16"
- 1- 2024R3/4"
- 1- 2026R13/16"
- 1- 2028R7/8"
- 1- 2030R15/16"
- 1- 2032R 1"
- 1- 2034R 1-1/16"
- 1- 2036R 1-1/8"
- 1- 2038R 1-3/16"
- 1- 2040R 1-1/4"
- 1- 2042R 1-5/16"
- 1- 2044R 1-3/8"
- 1- 2046R 1-7/16"
- 1- 2048R 1-1/2"

1/2" Drive Deep Fractional Sizes:

- 1- 2010D5/16"
- 1- 2012D3/8"
- 1- 2014D7/16"
- 1- 2016D1/2"
- 1- 2018D9/16"
- 1- 2020D5/8"
- 1- 2022D11/16"
- 1- 2024D3/4"
- 1- 2026D13/16"
- 1- 2028D7/8"
- 1- 2030D15/16"
- 1- 2032D 1"
- 1- 2034D 1-1/16"
- 1- 2036D 1-1/8"
- 1- 2038D 1-3/16"
- 1- 2040D 1-1/4"
- 1- 2042D 1-5/16"
- 1- 2044D 1-3/8"
- 1- 2046D 1-7/16"
- 1- 2048D 1-1/2"

1/2" Drive Metric Sizes:

- 1- 2010M 10mm
- 1- 2011M 11mm
- 1- 2012M 12mm
- 1- 2013M 13mm
- 1- 2014M 14mm
- 1- 2015M 15mm
- 1- 2016M 16mm
- 1- 2017M 17mm
- 1- 2018M 18mm
- 1- 2019M 19mm
- 1- 2020M 20mm
- 1- 2021M 21mm
- 1- 2022M 22mm
- 1- 2023M 23mm
- 1- 2024M 24mm
- 1- 2025M 25mm
- 1- 2026M 26mm
- 1- 2027M 27mm
- 1- 2028M 28mm
- 1- 2029M 29mm
- 1- 2030M 30mm
- 1- 2032M 32mm
- 1- 2033M 33mm
- 1- 2034M 34mm
- 1- 2035M 35mm
- 1- 2036M 36mm

1/2" Drive Deep Metric Sizes:

- 1- 2010MD 10mm
- 1- 2011MD 11mm
- 1- 2012MD 12mm
- 1- 2013MD 13mm
- 1- 2014MD 14mm
- 1- 2015MD 15mm
- 1- 2016MD 16mm
- 1- 2017MD 17mm
- 1- 2018MD 18mm
- 1- 2019MD 19mm
- 1- 2020MD 20mm
- 1- 2021MD 21mm
- 1- 2022MD 22mm
- 1- 2023MD 23mm
- 1- 2024MD 24mm
- 1- 2025MD 25mm
- 1- 2026MD 26mm
- 1- 2027MD 27mm
- 1- 2028MD 28mm
- 1- 2029MD 29mm
- 1- 2030MD 30mm
- 1- 2032MD 32mm
- 1- 2033MD 33mm
- 1- 2034MD 34mm
- 1- 2035MD 35mm
- 1- 2036MD 36mm

Dimensions:

- Wall Mount: 24" W x 48-1/2" H x 8" D
- Free Standing: 24" W x 55-1/4" H x 15-1/2" D
- Weight: 103.0 lbs.

12 No. D290-12 1/2" Drive 12-Point Fractional & Metric Display **SAE** **MM**



90 Piece Display Contents:

1/2" Drive Fractional Sizes:

- 1- 2112R3/8"
- 1- 2114R7/16"
- 1- 2116R1/2"
- 1- 2118R9/16"
- 1- 2120R5/8"
- 1- 2122R11/16"
- 1- 2124R3/4"
- 1- 2126R13/16"
- 1- 2128R7/8"
- 1- 2130R15/16"
- 1- 2132R 1"
- 1- 2134R 1-1/16"
- 1- 2136R 1-1/8"
- 1- 2138R 1-3/16"
- 1- 2140R 1-1/4"
- 1- 2142R 1-5/16"
- 1- 2144R 1-3/8"
- 1- 2146R 1-7/16"
- 1- 2148R 1-1/2"

1/2" Drive Deep Fractional Sizes:

- 1- 2112D3/8"
- 1- 2114D7/16"
- 1- 2116D1/2"
- 1- 2118D9/16"
- 1- 2120D5/8"
- 1- 2122D11/16"
- 1- 2124D3/4"
- 1- 2126D13/16"
- 1- 2128D7/8"
- 1- 2130D15/16"
- 1- 2132D 1"
- 1- 2134D 1-1/16"
- 1- 2136D 1-1/8"
- 1- 2138D 1-3/16"
- 1- 2140D 1-1/4"
- 1- 2142D 1-5/16"
- 1- 2144D 1-3/8"
- 1- 2146D 1-7/16"
- 1- 2148D 1-1/2"

1/2" Drive Metric Sizes:

- 1- 2110M 10mm
- 1- 2111M 11mm
- 1- 2112M 12mm
- 1- 2113M 13mm
- 1- 2114M 14mm
- 1- 2115M 15mm
- 1- 2116M 16mm
- 1- 2117M 17mm
- 1- 2118M 18mm
- 1- 2119M 19mm
- 1- 2120M 20mm
- 1- 2121M 21mm
- 1- 2122M 22mm
- 1- 2123M 23mm
- 1- 2124M 24mm
- 1- 2125M 25mm
- 1- 2126M 26mm
- 1- 2127M 27mm
- 1- 2128M 28mm
- 1- 2129M 29mm
- 1- 2130M 30mm
- 1- 2132M 32mm
- 1- 2133M 33mm
- 1- 2134M 34mm
- 1- 2135M 35mm
- 1- 2136M 36mm

1/2" Drive Deep Metric Sizes:

- 1- 2110MD 10mm
- 1- 2111MD 11mm
- 1- 2112MD 12mm
- 1- 2113MD 13mm
- 1- 2114MD 14mm
- 1- 2115MD 15mm
- 1- 2116MD 16mm
- 1- 2117MD 17mm
- 1- 2118MD 18mm
- 1- 2119MD 19mm
- 1- 2120MD 20mm
- 1- 2121MD 21mm
- 1- 2122MD 22mm
- 1- 2123MD 23mm
- 1- 2124MD 24mm
- 1- 2125MD 25mm
- 1- 2126MD 26mm
- 1- 2127MD 27mm
- 1- 2128MD 28mm
- 1- 2129MD 29mm
- 1- 2130MD 30mm
- 1- 2132MD 32mm
- 1- 2133MD 33mm
- 1- 2134MD 34mm
- 1- 2135MD 35mm
- 1- 2136MD 36mm

Dimensions:

- Wall Mount: 24" W x 48-1/2" H x 8" D
- Free Standing: 24" W x 55-1/4" H x 15-1/2" D
- Weight: 93.0 lbs.

Displays



3/4" Drive 6-Point Impact Socket Displays



6 No. D354 3/4" Drive 6-Point Fractional Display SAE



54 Piece Display Contents:

Attachments:

- 1- **3007E** 7" Extension
- 1- **3008A** . . . 3/4" F. x 1/2" M. Adapter
- 1- **3009A** . . . 3/4" F. x 1" M. Adapter
- 1- **3009AB** . . 3/4" F. x 1" M. Adapter
w/ Steel Ball

3/4" Drive Fractional Sizes:

- 1- **3016R** 1/2"
- 1- **3018R** 9/16"
- 1- **3020R** 5/8"
- 1- **3022R** 11/16"
- 1- **3024R** 3/4"
- 1- **3026R** 13/16"
- 1- **3028R** 7/8"
- 1- **3030R** 15/16"
- 1- **3032R** 1"
- 1- **3034R** 1-1/16"
- 1- **3036R** 1-1/8"
- 1- **3038R** 1-3/16"
- 1- **3040R** 1-1/4"
- 1- **3042R** 1-5/16"
- 1- **3044R** 1-3/8"
- 1- **3046R** 1-7/16"
- 1- **3048R** 1-1/2"
- 1- **3050R** 1-9/16"
- 1- **3052R** 1-5/8"
- 1- **3054R** 1-11/16"
- 1- **3056R** 1-3/4"
- 1- **3058R** 1-13/16"
- 1- **3060R** 1-7/8"
- 1- **3062R** 1-15/16"
- 1- **3064R** 2"

3/4" Drive Deep Fractional Sizes:

- 1- **3016D** 1/2"
- 1- **3018D** 9/16"
- 1- **3020D** 5/8"
- 1- **3022D** 11/16"
- 1- **3024D** 3/4"
- 1- **3026D** 13/16"
- 1- **3028D** 7/8"
- 1- **3030D** 15/16"
- 1- **3032D** 1"
- 1- **3034D** 1-1/16"
- 1- **3036D** 1-1/8"
- 1- **3038D** 1-3/16"
- 1- **3040D** 1-1/4"
- 1- **3042D** 1-5/16"
- 1- **3044D** 1-3/8"
- 1- **3046D** 1-7/16"
- 1- **3048D** 1-1/2"
- 1- **3050D** 1-9/16"
- 1- **3052D** 1-5/8"
- 1- **3054D** 1-11/16"
- 1- **3056D** 1-3/4"
- 1- **3058D** 1-13/16"
- 1- **3060D** 1-7/8"
- 1- **3062D** 1-15/16"
- 1- **3064D** 2"

Dimensions:

- Wall Mount: 24" W x 48-1/2" H x 8" D
- Free Standing: 24" W x 55-1/4" H x 15-1/2" D
- Weight: 112.0 lbs.

6 No. D352M 3/4" Drive 6-Point Metric Display MM



52 Piece Display Contents:

3/4" Drive Metric Sizes:

- 1- **3019M** 19mm
- 1- **3020M** 20mm
- 1- **3021M** 21mm
- 1- **3022M** 22mm
- 1- **3023M** 23mm
- 1- **3024M** 24mm
- 1- **3025M** 25mm
- 1- **3026M** 26mm
- 1- **3027M** 27mm
- 1- **3028M** 28mm
- 1- **3029M** 29mm
- 1- **3030M** 30mm
- 1- **3031M** 31mm
- 1- **3032M** 32mm
- 1- **3033M** 33mm
- 1- **3034M** 34mm
- 1- **3035M** 35mm
- 1- **3036M** 36mm
- 1- **3038M** 38mm
- 1- **3040M** 40mm
- 1- **3041M** 41mm
- 1- **3042M** 42mm
- 1- **3043M** 43mm
- 1- **3044M** 44mm
- 1- **3046M** 46mm
- 1- **3050M** 50mm

3/4" Drive Deep Metric Sizes:

- 1- **3019MD** 19mm
- 1- **3020MD** 20mm
- 1- **3021MD** 21mm
- 1- **3022MD** 22mm
- 1- **3023MD** 23mm
- 1- **3024MD** 24mm
- 1- **3025MD** 25mm
- 1- **3026MD** 26mm
- 1- **3027MD** 27mm
- 1- **3028MD** 28mm
- 1- **3029MD** 29mm
- 1- **3030MD** 30mm
- 1- **3031MD** 31mm
- 1- **3032MD** 32mm
- 1- **3033MD** 33mm
- 1- **3034MD** 34mm
- 1- **3035MD** 35mm
- 1- **3036MD** 36mm
- 1- **3038MD** 38mm
- 1- **3040MD** 40mm
- 1- **3041MD** 41mm
- 1- **3042MD** 42mm
- 1- **3043MD** 43mm
- 1- **3044MD** 44mm
- 1- **3046MD** 46mm
- 1- **3050MD** 50mm

Dimensions:

- Wall Mount: 24" W x 48-1/2" H x 8" D
- Free Standing: 24" W x 55-1/4" H x 15-1/2" D
- Weight: 111.0 lbs.



3/4" Drive 12-Point Impact Socket Displays



12 No. D342-12 3/4" Drive 12-Point Fractional Display **SAE**



42 Piece Display Contents:

3/4" Drive Fractional Sizes:

1-3124R	3/4"
1-3126R	13/16"
1-3128R	7/8"
1-3130R	15/16"
1-3132R	1"
1-3134R	1-1/16"
1-3136R	1-1/8"
1-3138R	1-3/16"
1-3140R	1-1/4"
1-3142R	1-5/16"
1-3144R	1-3/8"
1-3146R	1-7/16"
1-3148R	1-1/2"
1-3150R	1-9/16"
1-3152R	1-5/8"
1-3154R	1-11/16"
1-3156R	1-3/4"
1-3158R	1-13/16"
1-3160R	1-7/8"
1-3162R	1-15/16"
1-3164R	2"

3/4" Drive Deep Fractional Sizes:

1-3124D	3/4"
1-3126D	13/16"
1-3128D	7/8"
1-3130D	15/16"
1-3132D	1"
1-3134D	1-1/16"
1-3136D	1-1/8"
1-3138D	1-3/16"
1-3140D	1-1/4"
1-3142D	1-5/16"
1-3144D	1-3/8"
1-3146D	1-7/16"
1-3148D	1-1/2"
1-3150D	1-9/16"
1-3152D	1-5/8"
1-3154D	1-11/16"
1-3156D	1-3/4"
1-3158D	1-13/16"
1-3160D	1-7/8"
1-3162D	1-15/16"
1-3164D	2"

Dimensions:

Wall Mount: 24" W x 48-1/2" H x 8" D
Free Standing: 24" W x 55-1/4" H x 15-1/2" D
Weight: 108.0 lbs.

12 No. D352M-12 3/4" Drive 12-Point Metric Display **MM**



52 Piece Display Contents:

3/4" Drive Metric Sizes:

1-3119M	19mm
1-3120M	20mm
1-3121M	21mm
1-3122M	22mm
1-3123M	23mm
1-3124M	24mm
1-3125M	25mm
1-3126M	26mm
1-3127M	27mm
1-3128M	28mm
1-3129M	29mm
1-3130M	30mm
1-3131M	31mm
1-3132M	32mm
1-3133M	33mm
1-3134M	34mm
1-3135M	35mm
1-3136M	36mm
1-3138M	38mm
1-3140M	40mm
1-3141M	41mm
1-3142M	42mm
1-3143M	43mm
1-3144M	44mm
1-3146M	46mm
1-3150M	50mm

3/4" Drive Deep Metric Sizes:

1-3119MD	19mm
1-3120MD	20mm
1-3121MD	21mm
1-3122MD	22mm
1-3123MD	23mm
1-3124MD	24mm
1-3125MD	25mm
1-3126MD	26mm
1-3127MD	27mm
1-3128MD	28mm
1-3129MD	29mm
1-3130MD	30mm
1-3131MD	31mm
1-3132MD	32mm
1-3133MD	33mm
1-3134MD	34mm
1-3135MD	35mm
1-3136MD	36mm
1-3138MD	38mm
1-3140MD	40mm
1-3141MD	41mm
1-3142MD	42mm
1-3143MD	43mm
1-3144MD	44mm
1-3146MD	46mm
1-3150MD	50mm

Dimensions:

Wall Mount: 24" W x 48-1/2" H x 8" D
Free Standing: 24" W x 55-1/4" H x 15-1/2" D
Weight: 124.0 lbs.

Displays



1" Drive 6-Point Impact Socket Displays



6 No. D445 1" Drive 6-Point Fractional Display SAE



45 Piece Display Contents:

Attachments:

- 1- 4007E 7" Extension
- 1- 4008A 1" F x 3/4" M. Adapter
- 1- 4008AB 1" F x 3/4" M. Adapter w/ Steel Ball

1" Drive Fractional Sizes:

- 1- 4024R 3/4"
- 1- 4026R 13/16"
- 1- 4028R 7/8"
- 1- 4030R 15/16"
- 1- 4032R 1"
- 1- 4034R 1-1/16"
- 1- 4036R 1-1/8"
- 1- 4038R 1-3/16"
- 1- 4040R 1-1/4"
- 1- 4042R 1-5/16"
- 1- 4044R 1-3/8"
- 1- 4046R 1-7/16"
- 1- 4048R 1-1/2"
- 1- 4050R 1-9/16"
- 1- 4052R 1-5/8"
- 1- 4054R 1-11/16"
- 1- 4056R 1-3/4"
- 1- 4058R 1-13/16"
- 1- 4060R 1-7/8"
- 1- 4062R 1-15/16"
- 1- 4064R 2"

1" Drive Deep Fractional Sizes:

- 1- 4024D 3/4"
- 1- 4026D 13/16"
- 1- 4028D 7/8"
- 1- 4030D 15/16"
- 1- 4032D 1"
- 1- 4034D 1-1/16"
- 1- 4036D 1-1/8"
- 1- 4038D 1-3/16"
- 1- 4040D 1-1/4"
- 1- 4042D 1-5/16"
- 1- 4044D 1-3/8"
- 1- 4046D 1-7/16"
- 1- 4048D 1-1/2"
- 1- 4050D 1-9/16"
- 1- 4052D 1-5/8"
- 1- 4054D 1-11/16"
- 1- 4056D 1-3/4"
- 1- 4058D 1-13/16"
- 1- 4060D 1-7/8"
- 1- 4062D 1-15/16"
- 1- 4064D 2"

Dimensions:

- Wall Mount: 24" W x 48-1/2" H x 8" D
- Free Standing: 24" W x 55-1/4" H x 15-1/2" D
- Weight: 125.0 lbs.

6 No. D446M 1" Drive 6-Point Metric Display MM



46 Piece Display Contents:

1" Drive Metric Sizes:

- 1- 4019M 19mm
- 1- 4021M 21mm
- 1- 4022M 22mm
- 1- 4023M 23mm
- 1- 4024M 24mm
- 1- 4025M 25mm
- 1- 4026M 26mm
- 1- 4027M 27mm
- 1- 4028M 28mm
- 1- 4029M 29mm
- 1- 4030M 30mm
- 1- 4031M 31mm
- 1- 4032M 32mm
- 1- 4033M 33mm
- 1- 4035M 35mm
- 1- 4036M 36mm
- 1- 4038M 38mm
- 1- 4040M 40mm
- 1- 4041M 41mm
- 1- 4042M 42mm
- 1- 4043M 43mm
- 1- 4046M 46mm
- 1- 4050M 50mm

1" Drive Deep Metric Sizes:

- 1- 4019MD 19mm
- 1- 4021MD 21mm
- 1- 4022MD 22mm
- 1- 4023MD 23mm
- 1- 4024MD 24mm
- 1- 4025MD 25mm
- 1- 4026MD 26mm
- 1- 4027MD 27mm
- 1- 4028MD 28mm
- 1- 4029MD 29mm
- 1- 4030MD 30mm
- 1- 4031MD 31mm
- 1- 4032MD 32mm
- 1- 4033MD 33mm
- 1- 4035MD 35mm
- 1- 4036MD 36mm
- 1- 4038MD 38mm
- 1- 4040MD 40mm
- 1- 4041MD 41mm
- 1- 4042MD 42mm
- 1- 4043MD 43mm
- 1- 4046MD 46mm
- 1- 4050MD 50mm

Dimensions:

- Wall Mount: 24" W x 48-1/2" H x 8" D
- Free Standing: 24" W x 55-1/4" H x 15-1/2" D
- Weight: 112.0 lbs.



1" Drive 12-Point & Tire Service Displays



12 No. D434-12 1" Drive 12-Point Fractional Display SAE



34 Piece Display Contents:

1" Drive Fractional Sizes:

1- 4232R	1"
1- 4234R	1-1/16"
1- 4236R	1-1/8"
1- 4238R	1-3/16"
1- 4240R	1-1/4"
1- 4242R	1-5/16"
1- 4244R	1-3/8"
1- 4246R	1-7/16"
1- 4248R	1-1/2"
1- 4250R	1-9/16"
1- 4252R	1-5/8"
1- 4254R	1-11/16"
1- 4256R	1-3/4"
1- 4258R	1-13/16"
1- 4260R	1-7/8"
1- 4262R	1-15/16"
1- 4264R	2"

1" Drive Deep Fractional Sizes:

1- 4232D	1"
1- 4234D	1-1/16"
1- 4236D	1-1/8"
1- 4238D	1-3/16"
1- 4240D	1-1/4"
1- 4242D	1-5/16"
1- 4244D	1-3/8"
1- 4246D	1-7/16"
1- 4248D	1-1/2"
1- 4250D	1-9/16"
1- 4252D	1-5/8"
1- 4254D	1-11/16"
1- 4256D	1-3/4"
1- 4258D	1-13/16"
1- 4260D	1-7/8"
1- 4262D	1-15/16"
1- 4264D	2"

Dimensions:

Wall Mount: 24" W x 48-1/2" H x 8" D

Free Standing: 24" W x 55-1/4" H x 15-1/2" D

Weight: 122.0 lbs.

No. D139 Tire & Wheel Service Display SAE MM

Includes the most popular tire and wheel service sockets to service both passenger vehicles and light trucks as well as heavy duty trucks.



39 Piece Display Contents:

1/2" Drive Flip:

1- 2146DT	3/4" x 13/16"
1- 2192DT	19mm x 21mm

Adapters:

1- 3008A	3/4" F. x 1/2" M.
1- 3009A	3/4" F. x 1" M.
1- 4008A	1" F. x 3/4" M.

3/4" Drive Sizes:

1- 3007E	7" Extension
1- 3313S	13/16" Square
1- 3317S	17mm Square
1- 3028D	7/8" Deep
1- 3032D	1" Deep
1- 3038D	1-3/16" Deep
1- 3034DT	1-1/16" TW
1- 3036DT	1-1/8" TW
1- 3040DT	1-1/4" TW
1- 3048D	1-1/2" Deep
1- 3048DB	1-1/2" Dp Budd
1- 3223C	1-1/2" x 13/16" Sq.
1- 3027MD	27mm Deep
1- 3030MD	30mm Deep
1- 3033MD	33mm Deep
1- 3035MD	35mm Deep

1" Drive Sizes:

1- 4007E	7" Extension
1- 4313S	13/16" Square
1- 4317S	17mm Square
1- 4321S	21mm Square
1- 4028R	7/8"
1- 4032R	1"
1- 4038R	1-3/16"
1- 4034DT	1-1/16" TW
1- 4036DT	1-1/8" TW
1- 4040DT	1-1/4" TW
1- 4048D	1-1/2" Deep
1- 4048DB	1-1/2" Dp Budd
1- 4033M	33mm
1- 4033MD	33mm Deep
1- 4035MD	35mm Deep
1- 4041MD	41mm Deep
1- 4223C	1-1/2" x 13/16" Sq.
1- 4241MC	41mm x 21mm Sq.

Dimensions:

Wall Mount: 24" W x 48-1/2" H x 8" D

Free Standing: 24" W x 55-1/4" H x 15-1/2" D

Weight: 99.0 lbs.

Displays



Hex Driver Display & Display Components



No. D157H 1/4", 3/8" & 1/2" Hex Driver Display



Dimensions:
 Wall Mount: 24" W x 48-1/2" H x 8" D
 Free Standing: 24" W x 55-1/4" H x 15-1/2" D
 Weight: 54.0 lbs.

Includes a complete range of individual Hex Drivers as well as the most popular sets.

57 Piece Display Contents:

1/4" Drive Fractional Sizes:

1- 9904F	1/8"
1- 9905F	5/32"
1- 9906F	3/16"
1- 9907F	7/32"
1- 9908F	1/4"
1- 9910F	5/16"
1- 9912F	3/8"

1/4" Drive Metric Sizes:

1- 9902M	2mm
1- 9925M	2.5mm
1- 9903M	3mm
1- 9904M	4mm
1- 9905M	5mm
1- 9906M	6mm
1- 9907M	7mm
1- 9908M	8mm
1- 9910M	10mm

3/8" Drive Fractional Sizes:

1- 1906F	3/16"
1- 1907F	7/32"
1- 1908F	1/4"
1- 1910F	5/16"
1- 1912F	3/8"
1- 1914F	7/16"
1- 1916F	1/2"

3/8" Drive Metric Sizes:

1- 1904M	4mm
1- 1905M	5mm
1- 1906M	6mm
1- 1907M	7mm
1- 1908M	8mm
1- 1910M	10mm
1- 1912M	12mm

1/2" Drive Fractional Sizes:

1- 2908F	1/4"
1- 2909F	9/32"
1- 2910F	5/16"
1- 2912F	3/8"
1- 2914F	7/16"
1- 2916F	1/2"
1- 2918F	9/16"
1- 2920F	5/8"
1- 2922F	11/16"
1- 2924F	3/4"

1/2" Drive Metric Sizes:

1- 2906M	6mm
1- 2907M	7mm
1- 2908M	8mm
1- 2910M	10mm
1- 2911M	11mm
1- 2912M	12mm
1- 2913M	13mm
1- 2914M	14mm
1- 2915M	15mm
1- 2916M	16mm
1- 2917M	17mm
1- 2918M	18mm
1- 2919M	19mm

Fractional Sets

7 piece - 1297H	3/8" Drive
10 piece - 1398H	1/2" Drive

Metric Sets

7 piece - 1297MH	3/8" Drive
10 piece - 1498MH	1/2" Drive

Custom Display Components

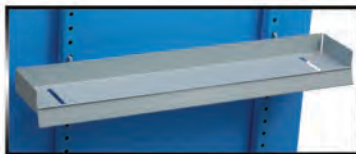

Item Number	Description
-------------	-------------

BASE RACK

DBASE	Display rack, includes coroplast backer & sign holder
LEGKIT	Set of legs for DBASE (1 pair)

SHELVES

4SHELF	4" Shelf for display (used for most sockets)
6SHELF	6" Shelf for display (used for small sets & large sockets)

RAIL & CLIPS

CRAILKIT	Metal rail for socket clips includes mounting hardware
14CLIP	1/4" clip for rail (each)
38CLIP	3/8" clip for rail (each)
12CLIP	1/2" clip for rail (each)
34CLIP	3/4" clip for rail (each)
1CLIP	1" clip for rail (each)

SIGNAGE

GENERICARD	Generic GP "IMPACT SOCKETS" Header Card 8" x 24"
SCHANNEL	Blank sign channel for 4" & 6" shelves (white)

Displays



Impact Chisels - .401 "Turn-Type" Shank



We offer Impact Chisels in .401 and .498 shank for use with pneumatic hammers. Each Chisel is designed for a specific job or application and is made from the highest quality steel finished with a black oxide coating for exceptional quality and durability. We back it up with our GP Lifetime Warranty.

All Chisels are packaged in hanging blister packs. Sets are packaged in molded trays with a hanging box for retail display. The molded tray serves as a tool box organizer for the technician.

No. CH100 1/2" Flat Chisel **.401**



Dimensions	A	B	C	D	E	F
Inches	.50	.401	5.27	1.73	7.00	.49
Millimeters	12.7	10.2	133.9	44.0	180.0	12.5

No. CH101 5/8" Flat Chisel **.401**



Dimensions	A	B	C	D	E	F
Inches	.63	.401	5.27	1.73	7.00	.49
Millimeters	16.0	10.2	133.9	44.0	180.0	12.5

No. CH102 3/4" Flat Chisel **.401**



Dimensions	A	B	C	D	E	F
Inches	.75	.401	5.27	1.73	7.00	.49
Millimeters	19.0	10.2	133.9	44.0	180.0	12.5

No. CH103 1-1/2" Flat Chisel **.401**



Dimensions	A	B	C	D	E	F
Inches	1.50	.401	5.27	1.73	7.00	.49
Millimeters	38.0	10.2	133.9	44.0	180.0	12.5

No. CH104 3/4" Flat Chisel - 11" Length **.401**



Dimensions	A	B	C	D	E	F
Inches	.75	.401	9.27	1.73	11.00	.49
Millimeters	19.0	10.2	235.5	44.0	280.0	12.5

No. CH105 3/4" Flat Chisel - 18" Length **.401**



Dimensions	A	B	C	D	E	F
Inches	.75	.401	16.27	1.73	18.00	.49
Millimeters	19.0	10.2	413.3	44.0	450.0	12.5

No. CH110 Claw Ripper & Panel Cutter **.401**



Dimensions	A	B	C	D	E	F
Inches	.65	.401	5.27	1.73	7.00	.49
Millimeters	16.0	10.2	133.9	44.0	180.0	12.5

No. CH111 Tapered Punch **.401**



Dimensions	A	B	C	D	E	F
Inches	.12	.401	5.27	1.73	7.00	.49
Millimeters	3.0	10.2	133.9	44.0	180.0	12.5

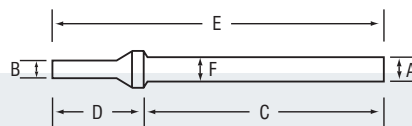

WARNING: Always wear safety goggles when using Impact Tools. Use only properly matched fractional or metric sizes.



Impact Chisels - .401 "Turn-Type" Shank



No. CH112 1-1/4" Chisel-Scraper .401



Dimensions	A	B	C	D	E	F
Inches	1.25	.401	5.77	1.73	7.50	.49
Millimeters	32.0	10.2	146.6	44.0	190.0	12.5

No. CH113 Straight Punch .401



Dimensions	A	B	C	D	E	F
Inches	.49	.401	5.27	1.73	7.00	.49
Millimeters	12.4	10.2	133.9	44.0	180.0	12.5

No. CH114 Single Blade Panel Cutter .401



Dimensions	A	B	C	D	E	F
Inches	.79	.401	5.27	1.73	7.00	.49
Millimeters	20.0	10.2	133.9	44.0	180.0	12.5

No. CH115 Dual Blade Panel Cutter .401



Dimensions	A	B	C	D	E	F
Inches	.87	.401	4.77	1.73	6.50	.49
Millimeters	22.0	10.2	121.2	44.0	165.0	12.5

No. CH116 Rivet Cutter .401



Dimensions	A	B	C	D	E	F
Inches	.63	.401	4.77	1.73	6.50	.49
Millimeters	16.0	10.2	121.2	44.0	165.0	12.5

1" Hammer - Standard & 7" Length .401



CH117

CH117-7

Item Number	Dimensions	A	B	C	D	E	F
CH117	Inches	1.00	.401	2.40	1.73	4.13	.49
CH117-7	Inches	1.00	.401	5.27	1.73	7.00	.49

No. CH118 Bushing Splitter .401



Dimensions	A	B	C	D	E	F
Inches	.49	.401	5.77	1.73	7.50	.49
Millimeters	12.4	10.2	146.6	44.0	190.0	12.5

No. CH119 Tailpipe Cutter .401



Dimensions	A	B	C	D	E	F
Inches	.98	.401	5.27	1.73	7.00	.49
Millimeters	25.0	10.2	133.9	44.0	180.0	12.5

WARNING: Always wear safety goggles when using Impact Tools. Use only properly matched fractional or metric sizes.

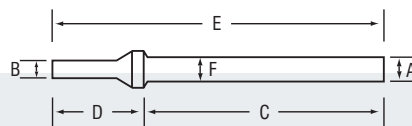



Impact Chisels - .401 "Turn-Type" Shank



No. CH120 Muffler Cutter .401



Dimensions	A	B	C	D	E	F
Inches	.60	.401	5.27	1.73	7.00	.49
Millimeters	15.2	10.2	133.9	44.0	180.0	12.5

No. CH121 Muffler & Pipe Cutter .401



Dimensions	A	B	C	D	E	F
Inches	1.10	.401	5.77	1.73	7.50	.49
Millimeters	28.0	10.2	146.6	44.0	190.0	12.5

No. CH122 Outside Muffler Pipe Cutter .401



Dimensions	A	B	C	D	E	F
Inches	1.00	.401	6.52	1.73	8.25	.49
Millimeters	25.4	10.2	165.6	44.0	210.0	12.5

No. CH123 Inside Muffler Pipe Cutter .401



Dimensions	A	B	C	D	E	F
Inches	1.00	.401	6.52	1.73	8.25	.49
Millimeters	25.4	10.2	165.6	44.0	210.0	12.5

No. CH124 Spot Weld Cutter .401



Dimensions	A	B	C	D	E	F
Inches	.72	.401	5.27	1.73	7.00	.49
Millimeters	18.0	10.2	133.9	44.0	180.0	12.5

No. CH125 5/16" Nut Splitter - 6" Long .401



Dimensions	A	B	C	D	E	F
Inches	.77	.401	4.27	1.73	6.00	.49
Millimeters	20.0	10.2	108.5	44.0	150.0	12.5

No. CH126 3/8" Nut Splitter - 10" Long .401

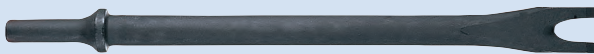

Dimensions	A	B	C	D	E	F
Inches	.77	.401	8.27	1.73	10.00	.49
Millimeters	20.0	10.2	210.1	44.0	250.0	12.5

No. CH127 3/8" Nut Splitter - 18" Long .401



Dimensions	A	B	C	D	E	F
Inches	.77	.401	16.27	1.73	18.00	.49
Millimeters	20.0	10.2	413.3	44.0	450.0	12.5

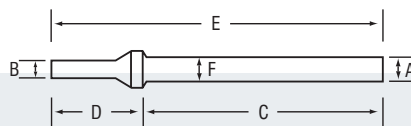



Impact Chisels - .498 "Turn-Type" Shank



.498 shank chisels have a larger shank size allowing them to be used with more powerful tools. Each chisel is designed specifically for heavy duty applications. Use with our model CH8001 chisel retainer for maximum safety and durability.

No. CH801 5/8" Flat Chisel .498



Dimensions	A	B	C	D	E	F
Inches	.63	.498	5.27	1.73	7.00	.63
Millimeters	16.0	12.7	133.9	44.0	180.0	16.0

No. CH803 1-1/2" Flat Chisel .498



Dimensions	A	B	C	D	E	F
Inches	1.50	.498	5.27	1.73	7.00	.63
Millimeters	38.0	12.7	133.9	44.0	180.0	16.0

No. CH811 Tapered Punch .498



Dimensions	A	B	C	D	E	F
Inches	.13	.498	5.27	1.73	7.00	.63
Millimeters	3.0	12.7	133.9	44.0	180.0	16.0

No. CH812 1-1/4" Chisel-Scraper .498



Dimensions	A	B	C	D	E	F
Inches	1.25	.498	5.27	1.73	7.00	.63
Millimeters	32.0	12.7	133.9	44.0	180.0	16.0

No. CH813 Straight Punch .498



Dimensions	A	B	C	D	E	F
Inches	.50	.498	5.27	1.73	7.00	.63
Millimeters	12.7	12.7	133.9	44.0	180.0	16.0

No. CH815 Dual Blade Panel Cutter .498



Dimensions	A	B	C	D	E	F
Inches	.94	.498	5.27	1.73	7.00	.63
Millimeters	24.0	12.7	133.9	44.0	180.0	16.0

No. CH816 Rivet Cutter .498



Dimensions	A	B	C	D	E	F
Inches	.76	.498	4.77	1.73	6.50	.63
Millimeters	20.0	12.7	121.2	44.0	165.0	16.0

No. CH817 1-1/4" Hammer .498



Dimensions	A	B	C	D	E	F
Inches	1.25	.498	2.40	1.73	4.13	.63
Millimeters	32.0	12.7	61.0	44.0	105.0	16.0

No. CH818 Bushing Splitter .498



Dimensions	A	B	C	D	E	F
Inches	.63	.498	5.27	1.73	7.00	.63
Millimeters	16.0	12.7	133.9	44.0	180.0	16.0

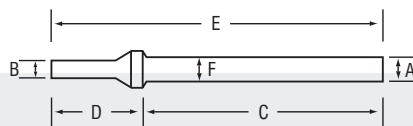

WARNING: Always wear safety goggles when using Impact Tools. Use only properly matched fractional or metric sizes.





No. CS110 General Service Impact Chisel Set

.401

This set contains the most popular .401 shank chisels to handle a wide variety of job types.



10 piece set contents:

- | | |
|-----------------------------|----------------------------------|
| CH116.....Rivet Cutter | CH118..... Bushing Splitter |
| CH102..... 3/4" Flat Chisel | CH120..... Muffler Cutter |
| CH113..... Straight Punch | CH125..... 5/16" Nut Splitter |
| CH111..... Tapered Punch | CH115... Dual Blade Panel Cutter |
| CH110..... Panel Cutter | CH117..... 1" Hammer |

Packaged in a molded storage tray with hanging box for display.

No. CS106 Exhaust Service Impact Chisel Set

.401

This set contains the most popular .401 shank chisels for exhaust and muffler service.



6 piece set contents:

- | | |
|-----------------------------|----------------------------------|
| CH102..... 3/4" Flat Chisel | CH121..... Muffler & Pipe Cutter |
| CH119..... Tailpipe Cutter | CH122.... Outside Muffler Cutter |
| CH120..... Muffler Cutter | CH123.... Inside Muffler Cutter |

Packaged in a molded storage tray with hanging box for display.

No. CS807 Heavy Duty General Service Chisel Set

.498

This set contains the most popular .498 shank chisels for heavy duty service work.



7 piece set contents:

- | | |
|-----------------------------|----------------------------------|
| CH801..... 5/8" Flat Chisel | CH815... Dual Blade Panel Cutter |
| CH811..... Tapered Punch | CH816..... Rivet Cutter |
| CH813..... Straight Punch | CH818..... Bushing Splitter |
| | CH817... 1-1/4" Diameter Hammer |

Packaged in a molded storage tray with hanging box for display.



Quick-Change Spring-Type Retainers .401 & .498 Shank



All items on this page are covered by a one year limited warranty.

These Quick-Change Spring-Type Retainers are made to fit a wide variety of Pneumatic Hammer models. Each retainer features a thumb lever that allows the tool to be changed quickly. See the chart below for the model to fit your specific tool. All quick-change spring retainers are packaged in hanging blister packs for ease of display and storage. One year limited warranty.

.401 Shank Quick-Change Spring-Type Chisel Retainers

.401



CH198



CH199

Item Number	APPLICATION	
	Manufacturer	Model
CH198	Chicago Pneumatic	All .401 except CP716
	Cleco	E3, E4, E15, E16
	Dayton	All Models
	Ingersoll-Rand Matco	115, 116, 117 All Models
CH199	American Pneumatic	All Models
	Chicago Pneumatic	CP716
	Desouter	All Models
	Ingersoll-Rand	121, 132, 772, AV10, AV12, AV13
	Sioux Superior	270-272 All Models

No. CH898

.498 Shank Quick-Change Spring-Type Chisel Retainer

.498

CH898 Quick-Change Retainer fits all Chicago Pneumatic .498 models.



Quick-Change Chisel Retainers

.401 .498



Item Number	Shank	APPLICATION	
		Manufacturer	Model
CH1001	.401	Chicago Pneumatic	All .401 except CP716
		Cleco	E3, E4, E15, E16
		Dayton	All Models
		Ingersoll-Rand Matco	115, 116, 117 All Models
CH1002	.401	American Pneumatic	All Models
		Chicago Pneumatic	CP716
		Desouter	All Models
		Ingersoll-Rand	121, 132, 772, AV10, AV12, AV13
		Sioux Superior	270-272 All Models
CH1003	.401	Florida Pneumatic Snap On	All Models PH45 - PH50
CH8001	.498	Chicago Pneumatic	All .498 Models





Conversion Chart



Conversion Chart Showing Millimeter Sizes, Fractional and Decimal Inch Sizes

(NOTE: To convert from inches to millimeters, multiply by 25.4; to convert from millimeters to inches, multiply by .03937.)

Fractions	Decimal Equiv.	Milli-meter	Fractions	Decimal Equiv.	Milli-meter	Fractions	Decimal Equiv.	Milli-meter	Fractions	Decimal Equiv.	Milli-meter
-	.0004	.010	35/64	.5470	13.891	-	1.3388	34.000	2-7/16	2.4380	61.913
-	.0040	.100	-	.5512	14.000	1-11/32	1.3440	34.131	-	2.4409	62.000
-	.0100	.250	9/16	.5630	14.288	1-3/8	1.3750	34.925	2-15/32	2.4690	62.706
1/64	.0156	.397	-	.5710	14.500	-	1.3779	35.000	-	2.4803	63.000
-	.0197	.500	37/64	.5780	14.684	1-13/32	1.4060	35.719	2-1/2	2.5000	63.500
-	.0295	.750	-	.5906	15.000	-	1.4173	36.000	-	2.5197	64.000
1/32	.03125	.794	19/32	.5940	15.081	1-7/16	1.4380	36.513	2-17/32	2.5310	64.294
-	.0394	1.000	39/64	.6090	15.478	-	1.4567	37.000	-	2.5590	65.000
3/64	.0469	1.191	5/8	.6250	15.875	1-15/32	1.4690	37.306	2-9/16	2.5620	65.088
-	.0590	1.500	-	.6299	16.000	-	1.4961	38.000	2-19/32	2.5940	65.881
1/16	.0620	1.588	41/64	.6406	16.272	1-1/2	1.5000	38.100	-	2.5984	66.000
5/64	.0781	1.984	-	.6496	16.500	1-17/32	1.5310	38.894	2-5/8	2.6250	66.675
-	.0787	2.000	21/32	.6560	16.669	-	1.5354	39.000	-	2.6380	67.000
3/32	.0940	2.381	-	.6693	17.000	1-9/16	1.5620	39.688	2-21/32	2.6560	67.469
-	.0984	2.500	43/64	.6720	17.066	-	1.5748	40.000	-	2.6772	68.000
7/64	.1090	2.778	11/16	.6875	17.463	1-19/32	1.5940	40.481	2-11/16	2.6875	68.263
-	.1181	3.000	45/64	.7030	17.859	-	1.6142	41.000	-	2.7165	69.000
1/8	.1250	3.175	-	.7087	18.000	1-5/8	1.6250	41.275	2-23/32	2.7190	69.056
-	.1378	3.500	23/32	.7190	18.256	-	1.6535	42.000	2-3/4	2.7500	69.850
9/64	.1410	3.572	-	.7283	18.500	1-21/32	1.6562	42.069	-	2.7559	70.000
5/32	.1560	3.969	47/64	.7340	18.653	1-11/16	1.6875	42.863	2-25/32	2.7810	70.6439
-	.1575	4.000	-	.7480	19.000	-	1.6929	43.000	-	2.7953	71.000
11/64	.1720	4.366	3/4	.7500	19.050	1-23/32	1.7190	43.656	2-13/16	2.8125	71.4376
-	.1770	4.500	49/64	.7656	19.447	-	1.7323	44.000	-	2.8346	72.000
3/16	.1875	4.763	25/32	.7810	19.844	1-3/4	1.7500	44.450	2-27/32	2.8440	72.2314
-	.1969	5.000	-	.7874	20.000	-	1.7717	45.000	-	2.8740	73.000
13/64	.2030	5.159	51/64	.7970	20.241	1-25/32	1.7810	45.244	2-7/8	2.8750	73.025
-	.2165	5.500	13/16	.8125	20.638	-	1.8110	46.000	2-29/32	2.9062	73.819
7/32	.2190	5.556	-	.8268	21.000	1-13/16	1.8125	46.038	-	2.9134	74.000
15/64	.2340	5.953	53/64	.8280	21.034	1-27/32	1.8440	46.831	2-15/16	2.9375	74.613
-	.2362	6.000	27/32	.8440	21.431	-	1.8504	47.000	-	2.9527	75.000
1/4	.2500	6.350	55/64	.8590	21.828	1-7/8	1.8750	47.625	2-31/32	2.9690	75.406
-	.2599	6.500	-	.8661	22.000	-	1.8898	48.000	-	2.9921	76.000
17/64	.2656	6.747	7/8	.8750	22.225	1-29/32	1.9062	48.419	3	3.0000	76.200
-	.2756	7.000	57/64	.8906	22.622	-	1.9291	49.000	3-1/32	3.0312	76.994
9/32	.2810	7.144	-	.9055	23.000	1-15/16	1.9375	49.213	-	3.0315	77.000
-	.2953	7.500	29/32	.9062	23.019	-	1.9685	50.000	3-1/16	3.0620	77.788
19/64	.2970	7.541	59/64	.9220	23.416	1-31/32	1.9690	50.006	-	3.0709	78.000
5/16	.3120	7.938	15/16	.9375	23.813	2	2.0000	50.800	3-3/32	3.0940	78.581
-	.3150	8.000	-	.9449	24.000	-	2.0079	51.000	-	3.1102	79.000
21/64	.3280	8.334	61/64	.9530	24.209	2-1/32	2.03125	51.594	3-1/8	3.1250	79.375
-	.3350	8.500	31/32	.9690	24.606	-	2.0472	52.000	-	3.1496	80.000
11/32	.3440	8.731	-	.9843	25.000	2-1/16	2.0620	52.388	3-5/32	3.1560	80.169
-	.3543	9.000	63/64	.9844	25.003	-	2.0866	53.000	3-3/16	3.1875	80.963
23/64	.3590	9.128	1	1.0000	25.400	2-3/32	2.0940	53.181	-	3.1890	81.000
-	.3740	9.500	-	1.0236	26.000	2-1/8	2.1250	53.975	3-7/32	3.2190	81.756
3/8	.3750	9.525	1-1/32	1.0312	26.194	-	2.1260	54.000	-	3.2283	82.000
25/64	.3910	9.922	1-1/16	1.0620	26.986	2-5/32	2.1560	54.769	3-1/4	3.2500	82.550
-	.3937	10.000	-	1.0630	27.000	-	2.1650	55.000	-	3.2677	83.000
13/32	.4060	10.319	1-3/32	1.0940	27.781	2-3/16	2.1875	55.563	3-9/32	3.2810	83.344
-	.4130	10.500	-	1.1024	28.000	-	2.2047	56.000	-	3.3071	84.000
27/64	.4220	10.716	1-1/8	1.1250	28.575	2-7/32	2.2190	56.356	3-5/16	3.3120	84.1377
-	.4331	11.000	-	1.1417	29.000	-	2.2440	57.000	3-11/32	3.3440	84.9314
7/16	.4380	11.113	1-5/32	1.1560	29.369	2-1/4	2.2500	57.150	-	3.3464	85.000
29/64	.4530	11.509	-	1.1811	30.000	2-9/32	2.2810	57.944	3-3/8	3.3750	85.725
15/32	.4690	11.906	1-3/16	1.1875	30.163	-	2.2835	58.000	-	3.3858	86.000
-	.4724	12.000	1-7/32	1.2190	30.956	2-5/16	2.3120	58.738	3-13/32	3.4060	86.519
31/64	.4840	12.303	-	1.2205	31.000	-	2.3228	59.000	-	3.4252	87.000
-	.4920	12.500	1-1/4	1.2500	31.750	2-11/32	2.3440	59.531	3-7/16	3.4380	87.313
1/2	.5000	12.700	-	1.2598	32.000	-	2.36622	60.000	-	3.4646	88.000
-	.5118	13.000	1-9/32	1.2810	32.544	2-3/8	2.3750	60.325	3-15/32	3.4690	88.106
33/64	.5156	13.097	-	1.2992	33.000	-	2.4016	61.000	3-1/2	3.5000	88.900
17/32	.5310	13.494	1-5/16	1.3120	33.338	2-13/32	2.4060	61.119			

Safety Rules

Important Words About Safety for Users and Bystanders



These safety recommendations simply reflect good engineering practice and are not intended to be a comprehensive set of rules. They compliment, but do not replace standard precautions to be taken by every user in compliance with professional guidelines, company procedures or national regulations. Keep and follow all power tool manufacturers operating instructions and safety rules. Remember, all the rules in the world cannot replace good common sense.

- Always wear eye, face, hand and body protective equipment while using or near the use of any Impact Tool or Attachment.
- Only use impact sockets with power driven or impact tools. Do not use impact sockets with hand tools such as ratchets, breaker bars, leverage bars or torque multipliers.
- Use only Impact Sockets or Chisels that are in good condition. Worn Tools reduce impact power and could also shatter, resulting in personal injury.
- Always select the correct size and type of Tool for the job to be done.
- When using a Universal Joint, Adapter or Extension Bar, never operate the Tool off the work.
- Use only Socket Retaining Pins designed for that purpose. Never use a make-shift pin.
- Never continue to hammer with an Impact Socket once the Fastener is tight.
- Always use the simplest hook-up possible. Long Extension Bars and Adapters absorb impact power and could break loose, resulting in personal injury.
- Never modify an Impact Socket from its original design to accomplish a task for which it was not intended.
- Never strike an Impact Socket or Chisel with a Hammer or other hard object.
- Never hold a Socket, Chisel, Universal Joint or other Attachment in your hand while the Power Tool is running.
- Keep tools away from Children.



GP Lifetime Warranty

Grey Pneumatic Impact Sockets, Duo-Sockets®, Ratchets & Chisels are warranted against defects in materials and workmanship for the life of the product. Quick change retainers and some special application items are warranted for one year from the date of purchase. Some items are No-Warranty and are marked on the product. These warranties do not apply to items that have been misused, abused, altered in any way, or worn out from use. Grey Pneumatic makes no other warranties with respect to our products or their suitability for specific applications.

Sets: Warranty on sets applies to the individual parts within the set. If one part is deemed defective we will replace that part and not the complete set.

Ratchets: Grey Pneumatic will at its option, provide repair parts, repair or replace any ratchet deemed defective. Use of handle extension bars will void all ratchet warranty as will visible signs of abuse to the handle or any other areas.

All claimed defective tools must be returned to the place of purchase for replacement. In cases where there is a question regarding defective or abused tools, the distributor will return them to Grey Pneumatic for a determination. After a determination is made we will credit, replace or repair the tool at our option. Tools that have been ground, filed, welded, hammered or modified in any way, are not covered under the GP Lifetime Warranty.

Grey Pneumatic shall not be liable for any consequential or incidental damages incurred by the purchaser. Buyer's sole and exclusive remedy for any loss incurred shall be a refund of the selling price.

EVERYTHING IMPACT®



Grey Pneumatic



www.gpsocket.com



Distributed by:

S12023

Date Printed: 01/2023

Printed in U.S.A.

© 2023 Grey Pneumatic,
All Rights Reserved.
Respective marks are
trademarks or registered
trademarks of Grey Pneumatic
in the US or other countries.